

**Datablad**

Art. Nr. 96.030.0153.0

fordeler RST20I3V 3P1 F V GL

RST20I3 3-pol Fordelerblok 250V/20A 1I/3O m. flange IP68 grå



Art. Nr.	96.030.0153.0
EAN	4015573734746
Ordre enhed	100 styk

**Godkendelser**

**Specifikationer**
**Generelt**

Nominel strøm	20 A
Nominel spænding	250 V
Nominel impuls spænding	4 kV
Forureningsgrad	3
låsbar	
Farve på kodning/kontaktindsats	lysegrå
Pol mærkning	L, N, PE

**Model**

Antal af indgange	1
Antal af udgange	3
Type fastgørelse	ja
Tæthedsklasse (IP)	IP66/68 (3m;2h) /IP69
fordeler type	fordelerblok

**Materiale**

Materiale kasse	Polyamid
Halogenfri	ja
Kontakt materiale	CuZn
brand belastning	0,231 kWh
Kontinuerlig temperatur, isolationsdele	100 °C
Overfladebehandling	forsølvet

**Dimensioner**

Længde	55,5 mm
Bredde	85,8 mm
Højde	31,3 mm

**Tilbehør**

Art. Nr.	Type	Beskrivelse
----------	------	-------------

05.564.4453.0	Blindprop for hanstik GL	RST20i3/2 blindprop, for afblinding af ubenyttet han stik, lysegrå
99.413.6205.2	Blindprop for hunstik GL	RST20i3/2 blindprop, for afblinding af ubenyttet hun stik, med snor, lysegrå
99.415.6205.2	Blindprop for hanstik GL	RST20i3/2 blindprop, for afblinding af ubenyttet han stik, med snor, lysegrå
Z5.564.4553.0	Blindprop for hunstik GL	RST20i3/2 blindprop, for afblinding af ubenyttet hun stik, lysegrå

drawn construction: 96.030.0153.0  
 Gezeichnete Ausführung: 96.030.0153.0

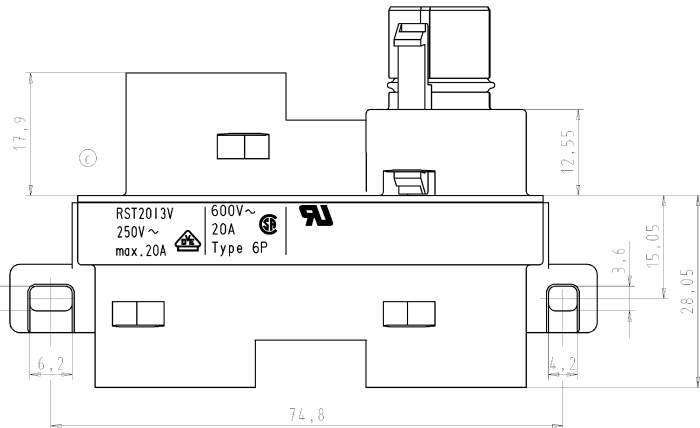
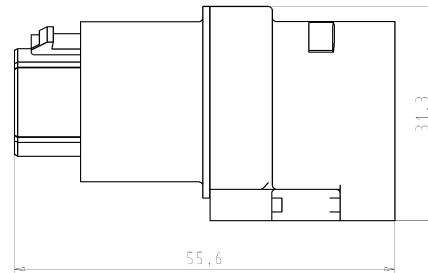
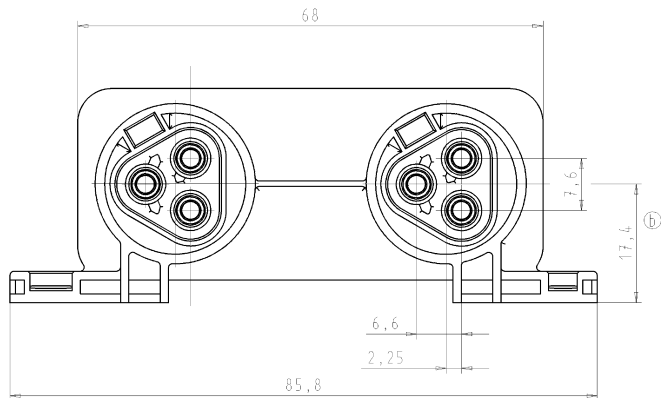

180°

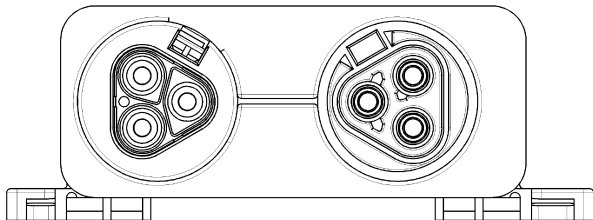

scale 1:1  
 Maßstab 1:1

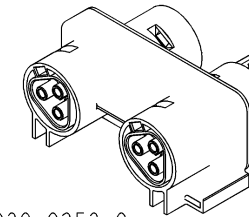
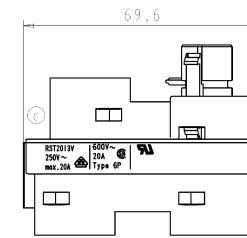

drawn construction: 96.030.0253.0  
 Ausführung: 96.030.0253.0

scale 1:1  
 Maßstab 1:1

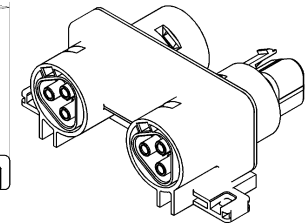
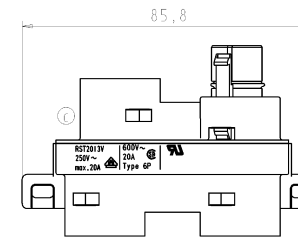

drawn construction: 96.030.0153.0  
 Ausführung: 96.030.0153.0

packaging unit: per 100  
 Verpackungseinheit: je 100 Stk.

Teile-Nr.	Type	Farbe	Variante
96.030.0153.1	RST2013V_3P1_F_V_SW	schwarz, ähnl. RAL 9005	mit Anschraubflansch
96.030.0153.0	RST2013V_3P1_F_V_GL	black, similar to RAL 9005	with screwing flange
96.030.0153.0	RST2013V_3P1_F_V_GL	grau, ähnl. RAL 7032	mit Anschraubflansch
96.030.0153.0	RST2013V_3P1_F_V_GL	grey, similar to RAL 7032	with screwing flange
96.030.0253.1	RST2013V_3P1_V_SW	schwarz, ähnl. RAL 9005	ohne Anschraubflansch
96.030.0253.1	RST2013V_3P1_V_SW	black, similar to RAL 9005	without screwing flange
96.030.0253.0	RST2013V_3P1_V_GL	grau, ähnl. RAL 7032	ohne Anschraubflansch
96.030.0253.0	RST2013V_3P1_V_GL	grey, similar to RAL 7032	without screwing flange

Erstellt/Gezeichnet von:	2003	Tag	Name	1. Verwendung	Bl. 1	von 1
Maßstab: 2:1	Estimiert	23.10.	Kreitz	T	Zeichnung Nr. 96.030.0153.0 01K c	
Wieland	Mikrotechische Verbindungen		Besenung		VERTEILER DISTRIBUTION BLOCK für RST2013/for RST2013	