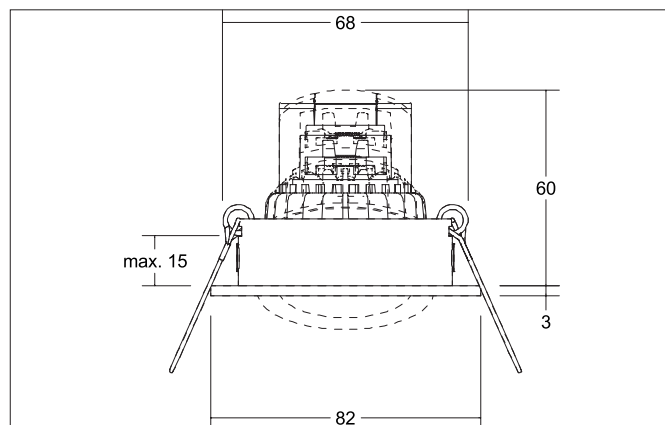

**LED recessed spot, on/off switchable**

Article no. 32024073

Light.  
For Generations.**Tender**

LED recessed spot, on/off switchable, Round. Ceiling cut-out Ø 68 mm, Installation depth 60 mm, Outer diameter 82 mm, Weight 0,143 kg, with rotationssymmetrical, deep, wide distributed light intensity. with max: 7 W, Delivery without bulb. Housing material: Aluminium / Glass / Plastic, Colour: White, Permissible ambient temperature (ta): -20 °C - +25 °C, Protection class (EN 61140): II, Degree of protection (DIN EN 60529): IP20. With electronic driver, on/off switchable.

Article data	
Article no.	32024073
GTIN	4251433951513
Short description	LED recessed spot, on/off switchable
Material	Aluminium / Glass / Plastic
Colour	White
Type of surface	Matt
Shape	Round
Outer diameter	82 mm
Built-in diameter	68 mm
Installation depth	60 mm
Weight	0.143 kg

**LED recessed spot, on/off switchable**

Article no. 32024073

Light.  
For Generations.

Lighting technology	
Colour temperature	3.000 K
Light colour	White
Light output	Direct
Luminous flux	630 lm
System efficiency	90 lm/W
Colour rendering	CRI > 80
Reflector	High-gloss
Beam angle	38°
Light sharing	Symmetric

Operating technology of the luminaire	
System output	7 W
Voltage type	AC
AC nominal voltage max	230 V
Frequenz max.	50 Hz
Lamp	LED
Protection class	II
Degree of protection	IP20
Control	on/off
Rated life time L80/B20 at 25 °C	30000 h

Mounting technology	
Mounting method	Recessed mounting
Place of installation	Ceiling-mounted
Adjustability	Pivoted
Swivel angle	20°
Further references	No cover with thermal insulation material

Packing data	
Gross weight	0.179 kg
Length of packaging	90 mm
Packaging width	90 mm
Packaging height	80 mm
Disposal at end of life	This product must not be disposed of with household waste. You are obliged, to dispose of such electrical waste separately. By disposing of electrical waste and other old or defective electronics separately, you support recycling or other forms of re-use. In that way you help to take care and to avoid that harmful substances get into the environment.