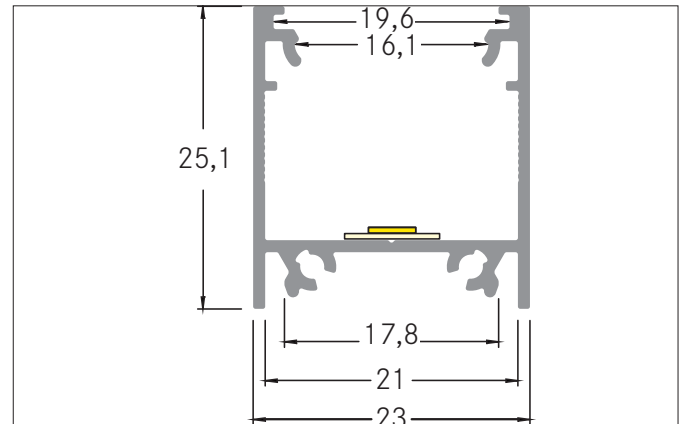

**Surface-mounted profile complete set 2000 mm**

Article no. 53922070

Light.  
For Generations.**Tender**

Surface-mounted profile complete set 2000 mm,. Mounting method: Mounting profile. Material: Aluminium / PMMA / Steel / Plastic, dimensions profile: length: 2.000 mm x width: 23 mm x height: 25,1 mm

**Product Benefits**

- One article number for profile, cover and mounting accessories.
- Fast order processing.
- Uncomplicated product selection.
- Suitable accessories included.

Article data	
Article no.	53922070
GTIN	4251433919339
Short description	Surface-mounted profile complete set 2000 mm
Material	Aluminium / PMMA / Steel / Plastic
Transmittance	70 %
Length	2,000 mm
Width	23 mm
Hight	25.1 mm
Weight	0.725 kg

**Surface-mounted profile complete set 2000 mm**

Article no. 53922070

Light.  
For Generations.

Packing data	
Gross weight	0.786 kg
Length of packaging	2,175 mm
Packaging width	75 mm
Packaging height	75 mm
Note	Please note that the materials aluminium and PMMA or PC can expand differently with changes in temperature! At a temperature change of 10°C, the coefficient of expansion is approx. aluminium is approx. 0.7mm per metre, for plastic approx. 1.5mm per metre. This is not a defect in the product, this is a normal physical process.
Disposal at end of life	This product must not be disposed of with household waste. You are obliged, to dispose of such electrical waste separately. By disposing of electrical waste and other old or defective electronics separately, you support recycling or other forms of re-use. In that way you help to take care and to avoid that harmful substances get into the environment.