

ALTERO-R LED recessed downlight, TunableWhite, IP44
Article no. 12035184TW

Light.
For Generations.

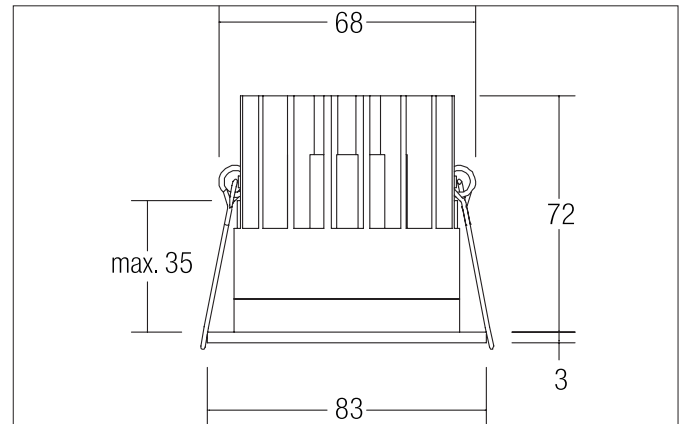

Tender

LED recessed downlight, TunableWhite, IP44, Round. Toolless ceiling installation by installation springs. Ceiling cut-out Ø 68 mm, Installation depth 72 mm, Outer diameter 83 mm, Weight 0,241 kg. Reflector silver with rotationssymmetrical, deep, wide distributed light intensity. optimal light distribution due to a glass transparent cover. Power 1 x 8,8 W, Light colour warm white to daylight white, Correlated color temperature (CCT) 2.700 - 6.500 K, Colour rendering index CRI > 90, Housing material: Aluminium, Colour: White structure, Permissible ambient temperature (ta): -20 °C - +25 °C, Protection class (EN 61140): III, Degree of protection (DIN EN 60529): IP44, .For connection to an external driver, which is not included in the scope of delivery of the luminaire. Depending on driver dimmable.

Article data	
Article no.	12035184TW
GTIN	4251433981909
Series name	ALTERO-R
Short description	LED recessed downlight, TunableWhite, IP44
Material	Aluminium
Colour	White
Type of surface	Structure
Shape	Round
Outer diameter	83 mm
Built-in diameter	68 mm
Installation depth	72 mm
Hight	3 mm
Weight	0.241 kg

ALTERO-R LED recessed downlight, TunableWhite, IP44

Article no. 12035184TW

Light.
For Generations.

Lighting technology	
Colour temperature	2.700 K - 6.500 K
Light colour	White
Light output	Direct
Luminous flux 1	740 lm
Luminous flux 2	850 lm
System efficiency	9 lm/W
Colour rendering	CRI > 90
Reflector	High-gloss
Reflector colour	silver
Beam angle	33°
Light sharing	Symmetric
Adjustable color temperature	Infinite control

Operating technology of the luminaire	
Voltage type	DC
Current	500 mA
Lamp	LED
Protection class	III
Degree of protection	IP44
Protection class on the ceiling side	IP20
Dimmable	Depending on type of control gear
Control	Depending on driver
Bulb change possible	The light source of this luminaire may only be replaced by the manufacturer or a service technician commissioned by him or a similarly qualified person.

Mounting technology	
Mounting method	Recessed mounting
Place of installation	Ceiling-mounted
Adjustability	Not adjustable
Max. ceiling thickness	35 mm
stamp	UKCA
Further references	No cover with thermal insulation material
Material cover	Glass transparent

Packing data	
Gross weight	0.291 kg
Length of packaging	100 mm
Packaging width	100 mm
Packaging height	100 mm
Disposal at end of life	This product must not be disposed of with household waste. You are obliged, to dispose of such electrical waste separately. By disposing of electrical waste and other old or defective electronics separately, you support recycling or other forms of re-use. In that way you help to take care and to avoid that harmful substances get into the environment.

Accessories	
-------------	--

Required accessories	
	Article no.: 17821010 LED converter 500 mA, TunableWhite, DALI-DT8 dimmable, 15 W Power: 2,5 - 15 W Dimensions: 178 mm x 46 mm x 22 mm