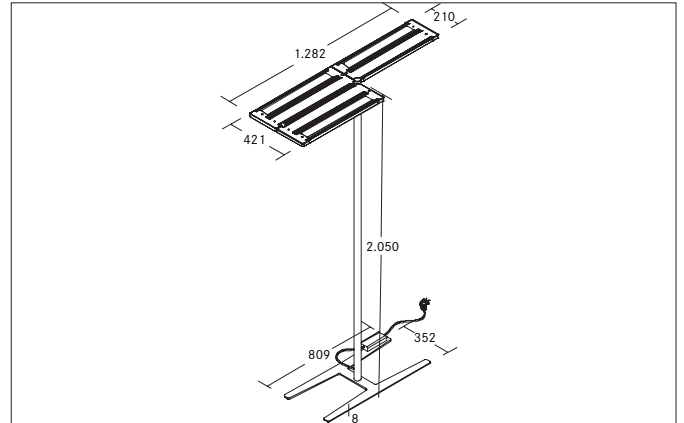

MELODY LED floor luminaire, NANO prismatic cover, with indirect light component

Article no. 77423184ST

Tender

Rectangular LED free-standing luminaire, NANO prismatic cover, with indirect component, height 2,050 mm, luminaire length 1,282 mm, luminaire width 421 mm, height 2,050 mm, weight 21.900 kg, double asymmetrical cover plastic microprismatic, rated luminous flux 22.800 lm, UGR < 19, rated wattage 180 W, neutral white light color, most similar color temperature (CCT) 4,000 K, general color rendering index CRI > 90, housing material: aluminum / steel / plastic, color: black, permissible ambient temperature (ta): -20 °C - +25 °C, protection class (EN 61140): I, degree of protection (DIN EN 60529): IP20. With electronic control gear, presence detector, daylight sensor, dimmable push-button.

Article data	
Article no.	77423184ST
GTIN	4251433954576
Series name	MELODY
Short description	LED floor luminaire, NANO prismatic cover, with indirect light component
Material	Aluminium / Steel / Plastic
Colour	Black
Type of surface	Structure
Shape	Rectangular
Length	1,282 mm
Width	421 mm
Hight	2,050 mm
Scope of delivery	incl. supply line 2.500 mm with Schuko angle plug
Weight	21.900 kg
Conformance	CE

MELODY LED floor luminaire, NANO prismatic cover, with indirect light component

Article no. 77423184ST

Lighting technology	
Colour temperature	4.000 K
Light colour	White
Light output	Direct/Indirect
Luminous flux	22,800 lm
Luminous flux component (direct / indirect)	16/84 %
System efficiency	127 lm/W
McAdam-Step	McAdam-Step 3
Colour rendering	CRI > 90
Glare evaluation	UGR < 19
Luminance < 3,000 cd/m ² above 65° beam angle	Yes
Light sharing	Double asymmetric
Adjustable color temperature	No

Operating technology of the luminaire	
System output	180 W
Voltage type	AC
AC nominal voltage max	230 V
Frequency max	50 Hz
Lamp	LED
Lamp holder	Without fitting
Protection class	I
Degree of protection	IP20
Control	Presence detector, Daylight detector, Button
Bulb change possible	The light source of this luminaire may only be replaced by the manufacturer or a service technician commissioned by him or a similarly qualified person.
Rated life time L90/B10 at 25 °C	50.000 h
Energy efficiency class	nicht erforderlich

Mounting technology	
Mounting method	Surface mounting
Place of installation	Floor-mounted
Adjustability	Not adjustable
Material cover	Plastic, microprismatic

Packing data	
Gross weight	26.022 kg
Length of packaging	2,085 mm
Packaging width	520 mm
Packaging height	95 mm
Disposal at end of life	This product must not be disposed of with household waste. You are obliged, to dispose of such electrical waste separately. By disposing of electrical waste and other old or defective electronics separately, you support recycling or other forms of re-use. In that way you help to take care and to avoid that harmful substances get into the environment.

Optional accessories	
Article no.: 18209000 MELODY sensor user remote control	
https://www.brumberg.com/fileadmin/products/Datenblatt_18209000_2021_DE.pdf	