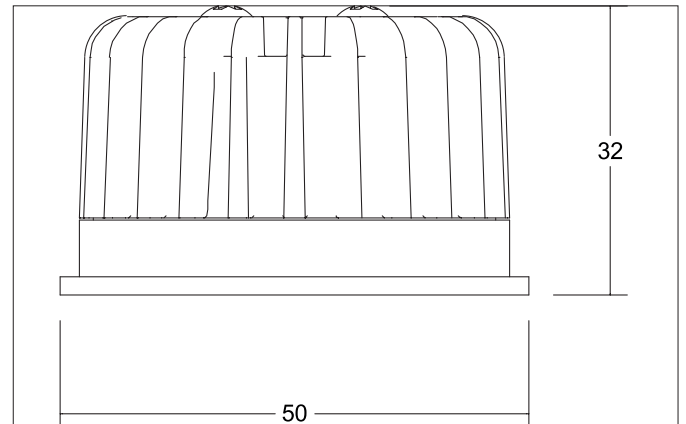

LED reflector insert MR16, 6 W, 350 mA

Article no. 12923603

Light.
For Generations.**Tender**

LED reflector insert MR16, 6 W, 350 mA, , Round.Lamp holder: Plug&Play, Material: Aluminium / Glass, Degree of protection: according to DIN EN 60529 IP20, Protection class: (EN 61140) III, Current: 350 mA, Power: 6 W, Luminous flux : 570 lm, Colour temperature: 2.700 K, Beam angle: 60°, without control gear, Control: Depending on driver.

Article data	
Article no.	12923603
GTIN	4251433936244
Short description	LED reflector insert MR16, 6 W, 350 mA
Material	Aluminium / Glass
Shape	Round
Outer diameter	50 mm
Hight	32 mm
Weight	0.078 kg
stamp	UKCA
Conformance	CE, UKCA

Lighting technology	
Colour temperature	2.700 K
Light colour	White
Luminous flux	570 lm
Colour rendering	CRI > 80
Reflector	High-gloss
Beam angle	60°
Light sharing	Symmetric

LED reflector insert MR16, 6 W, 350 mA

Article no. 12923603

Light.
For Generations.









Operating technology of the luminaire	
Voltage type	DC
Current	350 mA
Lamp	LED
Lamp holder	Plug&Play
Protection class	III
Degree of protection	IP20
Control	Depending on driver
Bulb change possible	The light source of this luminaire may only be replaced by the manufacturer or a service technician commissioned by him or a similarly qualified person.
Rated life time L80/B20 at 25 °C	50.000 h

Packing data	
Gross weight	0.089 kg
Length of packaging	55 mm
Packaging width	55 mm
Packaging height	65 mm
Disposal at end of life	This product must not be disposed of with household waste. You are obliged, to dispose of such electrical waste separately. By disposing of electrical waste and other old or defective electronics separately, you support recycling or other forms of re-use. In that way you help to take care and to avoid that harmful substances get into the environment.

LED reflector insert MR16, 6 W, 350 mA

Article no. 12923603

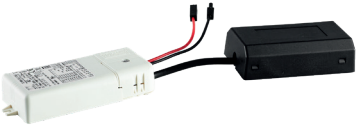
Light.
For Generations.

Required accessories	
	Article no.: 17662020 LED converter 350 mA, on/off switchable Power: 1 - 7,2 W Dimensions: 68 mm x 35 mm x 21 mm
	Article no.: 17613000 LED converter 350 mA, on/off switchable Power: 1 - 15 W Dimensions: 115 mm x 34 mm x 19 mm
	Article no.: 17621020 LED converter 350 mA, on/off switchable Power: 1 - 21 W Dimensions: 128 mm x 50 mm x 13 mm
	Article no.: 17663020 LED converter 350 mA, trailing-edge phase dimmable Power: 2,8 - 7 W Dimensions: 110 mm x 50 mm x 19 mm
	Article no.: 17652020 LED-round converter 350 mA, trailing-edge phase dimmer Power: 4,9 - 7 W Dimensions: 51 mm x 24 mm
	Article no.: 17640020 LED converter 350 mA, trailing-edge phase dimmable Power: 4,2 - 10 W Dimensions: 102 mm x 38 mm x 21 mm
	Article no.: 17657000 LED converter 350 mA, 1-10 V dimmable (analog) Power: 5,2 - 18 W Dimensions: 110 mm x 52 mm x 22 mm
	Article no.: 17683020 LED converter 350 mA, DALI dimmable (digital) Power: 3,5 - 17 W Dimensions: 110 mm x 52 mm x 22 mm
	Article no.: 17648020 LED converter 350 mA, trailing-edge phase dimmable Power: 0,7 - 17 W Dimensions: 166 mm x 46 mm x 34 mm
	Article no.: 17671020 LED converter 350mA, ZigBee dimmable Power: 3,5 - 18,5 W Dimensions: 146 mm x 44 mm x 30 mm