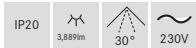
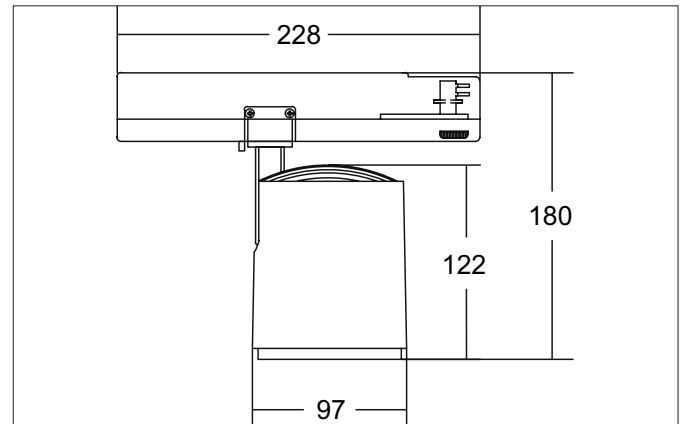

RETAIL ONE LED track spotlight, 31W

Article no. 88183164

Light.
For Generations.**Tender**

LED track spotlight, 31W, Round. Luminaire diameter 97.0 mm, Weight 0.872 kg, with rotationssymmetrical, deep, wide distributed light intensity. Luminous flux 3.889 lm, Power 1 x 31,2 W, Light colour neutral white, Correlated color temperature (CCT) 4.000 K, Colour rendering index CRI > 90, Rated life time L80/B50 at 25 °C: 50.000 h, Housing material: Aluminium, Colour: Silver structure, Permissible ambient temperature (ta): -20 °C - +25 °C, Protection class (EN 61140): I, Degree of protection (DIN EN 60529): IP20, .With electronic driver, on/off switchable.

| Article data | |
|-------------------|--------------------------|
| Article no. | 88183164 |
| GTIN | 4251433976462 |
| Series name | RETAIL ONE |
| Short description | LED track spotlight, 31W |
| Material | Aluminium |
| Colour | Silver |
| Type of surface | Structure |
| Shape | Round |
| Outer diameter | 97 mm |
| Weight | 0.872 kg |

RETAIL ONE LED track spotlight, 31W

Article no. 88183164

Light.
For Generations.

| Lighting technology | |
|------------------------------|------------|
| Colour temperature | 4.000 K |
| Light colour | White |
| Luminous flux | 3,889 lm |
| System efficiency | 125 lm/W |
| Colour rendering | CRI > 90 |
| Reflector | High-gloss |
| Beam angle | 30° |
| Light sharing | Symmetric |
| Adjustable color temperature | No |

| Operating technology of the luminaire | |
|---------------------------------------|--|
| System output | 31 W |
| Voltage type | AC |
| AC nominal voltage max | 230 V |
| Frequenz max. | 50 Hz |
| Lamp | LED |
| Lamp holder | Without fitting |
| Protection class | I |
| Degree of protection | IP20 |
| Control | on/off |
| Bulb change possible | The light source of this luminaire may only be replaced by the manufacturer or a service technician commissioned by him or a similarly qualified person. |
| Rated life time L80/B50 at 25 °C | 50.000 h |

| Mounting technology | |
|-----------------------------|-------------------------------|
| Mounting method | Surface mounting |
| Place of installation | Ceiling-mounted |
| Adjustability | Rotatable and adjustable head |
| Swivel angle | 90° |
| Rotation angle | 350° |
| Head adjustable angle | 90° |
| Suitable for through-wiring | No |

| Packing data | |
|-------------------------|---|
| Gross weight | 1.012 kg |
| Length of packaging | 290 mm |
| Packaging width | 110 mm |
| Packaging height | 165 mm |
| Disposal at end of life | This product must not be disposed of with household waste. You are obliged, to dispose of such electrical waste separately. By disposing of electrical waste and other old or defective electronics separately, you support recycling or other forms of re-use. In that way you help to take care and to avoid that harmful substances get into the environment. |