

ITANSA-S Recessed downlight, V4A, GU10, IP54
Article no. 36005220

Light.
For Generations.

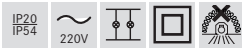
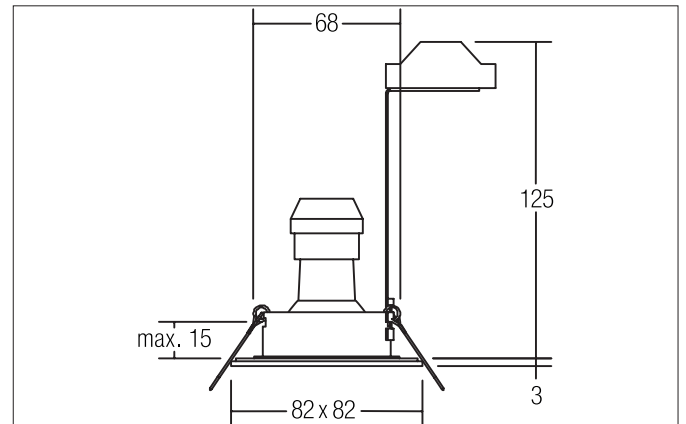

Tender

Recessed downlight, V4A, GU10, IP54, stainless steel matt, Square. In a compact design, for installation in tool-less rapid assembly systems. Including bracket with GU10 socket for standard-compliant strain relief. Lamp holder: GU10, Mounting method: Recessed mounting, Place of installation: Ceiling-mounted, Material: Stainless steel V4A / Glass, Degree of protection: according to DIN EN 60529 IP54, Protection class: (EN 61140) II, Voltage: 230V AC 50Hz, Power: 10 W, Amount of light sources / fittings: 1 Qty, Adjustability: Not adjustable, without control gear, Control: Other.

Article data	
Article no.	36005220
GTIN	425004778255 1
Series name	ITANSA-S
Short description	Recessed downlight, V4A, GU10, IP54
Material	Stainless steel
Colour	Stainless steel
Type of surface	Matt
Shape	Square
Built-in diameter	68 mm
Installation depth	125 mm
Length	82 mm
Width	82 mm
Height	3 mm
Weight	0.214 kg
Conformance	CE, UKCA

ITANSA-S Recessed downlight, V4A, GU10, IP54

Article no. 36005220

Light.
For Generations.

Operating technology of the luminaire	
System output	10 W
Voltage type	AC
AC nominal voltage max	220 V
Frequency max	50 Hz
Lamp	For LED-retrofill lamp
Lamp holder	GU10
Protection class	II
Degree of protection	IP54
Protection class on the ceiling side	IP20
Control	Other
Bulb change possible	Yes

Mounting technology	
Mounting method	Recessed mounting
Place of installation	Ceiling-mounted
Adjustability	Not adjustable
Max. ceiling thickness	15 mm
Further references	No cover with thermal insulation material
Material cover	Glass transparent
Circlip	Without circlip

Packing data	
Gross weight	0.281 kg
Length of packaging	140 mm
Packaging width	110 mm
Packaging height	120 mm
Disposal at end of life	This product must not be disposed of with household waste. You are obliged, to dispose of such electrical waste separately. By disposing of electrical waste and other old or defective electronics separately, you support recycling or other forms of re-use. In that way you help to take care and to avoid that harmful substances get into the environment.