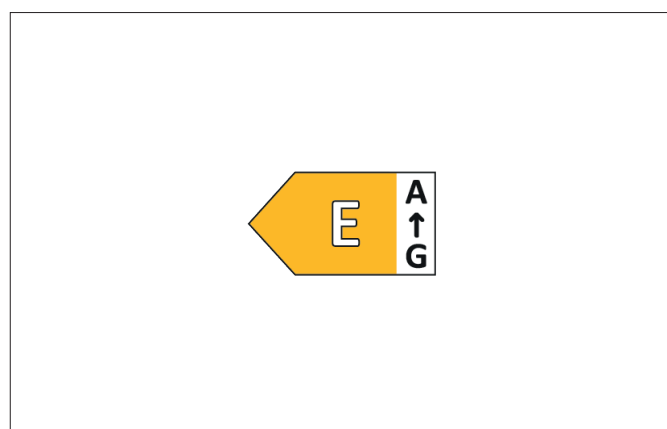
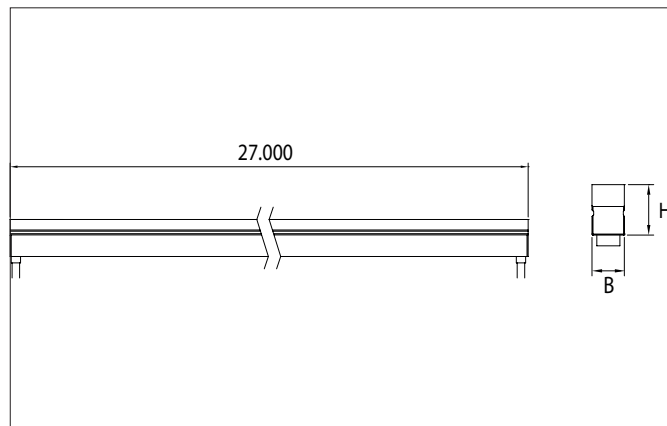
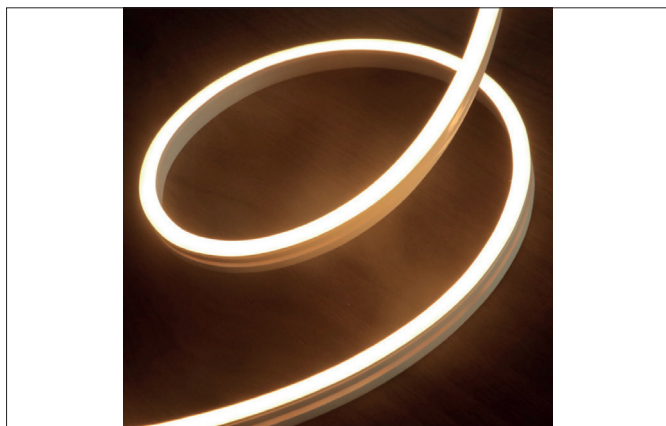

**QUALITYFLEX Protection Horizon Segment LED Flex lighting 50 m,****CRI > 90, 5 W / m, IP67**

Article no. 76582004

Light.  
For Generations.**Tender**

Segment LED Flex lighting 50 m, CRI > 90, 5 W / m, IP67, white, 4.000K, CRI > 90. LED flex lighting Length: 50.0 mm Lamp power per meter: 5.0 W/m, Luminous flux per meter: 150.0 lm/m, Degree of protection: IP67, Protection class: III, Voltage: 24V DC, Beam angle: 120.0 °, 120 LEDs per meter, Chip distance (Short Pitch) : 8,33mm. For individual application, the LED flex board can be used all 50 mm be cut back. If the LED flex board is shortened, the IP protection must be restored by the customer. The maximum system length of 27.000mm must not be exceeded with one feed-in.

**Product Benefits**

- Suitable for indoor and outdoor use (IP67).
- Divisible every 50 mm (IP65 protection).
- Ideal for terraces, facades and pool areas.
- Length 27,000 mm with a pitch of 50 mm.
- Lifetime L80/B10: 36,000 hours.
- Easy installation with matching aluminum profiles or mounting clips.
- Dimmable with appropriate accessories.

**QUALITYFLEX Protection Horizon Segment LED Flex lighting 50 m,****CRI > 90, 5 W / m, IP67**

Article no. 76582004

Light.  
For Generations.

Article data	
Article no.	76582004
GTIN	4251433971436
Series name	QUALITYFLEX Protection Horizon
Short description	Segment LED Flex lighting 50 m, CRI > 90, 5 W / m, IP67
Colour	White
Length	50 mm
Width	12 mm
Hight	20 mm
Scope of delivery	incl. 1 x mounting instructions, 5 x identification labels
Weight	0.030 kg
Length of the connection line	1,000 mm
Conformance	UKCA

Lighting technology	
Colour temperature	4.000 K
Light colour	White
Luminous flux per meter	150 lm/m
System efficiency	30 lm/W
McAdam-Step	McAdam-Step 2
Colour rendering	CRI > 90
Beam angle	120°
Adjustable color temperature	No

Operating technology of the luminaire	
Lamp power per meter	5 W/m
Voltage type	DC
DC nominal voltage max	24 V
Lamp	LED
Protection class	III
Degree of protection	IP67
Ambient temperature	-20 °C up to +50 °C
Dimmable	Yes
Wire number	2
Control	Depending on driver
Length of the connection line	1,000 mm
Cable assignment	red = + pole black = - pole
Design of the connecting cable	one-sided
Bulb change possible	No
Rated life time L70/B50 at 25 °C	54,000 h
Rated life time L80/B10 at 25 °C	36.000 h
Energy efficiency class	E

Operating technology of QualityFlex	
Power per meter	5 W/m
Short Pitch	8.33 mm
Number of lamps per meter	120 Qty
Length of individual sections	50 mm
Smallest bend radius	120 mm
Length	50 mm
Maximum module length	27,000 mm
Circuit type	Parallel conduction
LED Type	2835 LED

**QUALITYFLEX Protection Horizon Segment LED Flex lighting 50 m,****CRI > 90, 5 W / m, IP67**

Article no. 76582004

Light.  
For Generations.

Packing data	
Gross weight	0.034 kg
Length of packaging	490 mm
Packaging width	440 mm
Packaging height	40 mm
Disposal at end of life	This product must not be disposed of with household waste. You are obliged, to dispose of such electrical waste separately. By disposing of electrical waste and other old or defective electronics separately, you support recycling or other forms of re-use. In that way you help to take care and to avoid that harmful substances get into the environment.

Compatible Driver						
Article no.	Power min	Power	Control	Length	Width	Height
17206000	1 W	20 W	1-10 V	146 mm	55 mm	19 mm
17207000	1 W	30 W	on/off	160 mm	50 mm	22 mm
17214000	1 W	7.2 W	on/off	68 mm	35 mm	21 mm
17223000	1 W	75 W	on/off	185 mm	60 mm	31 mm
17224000	1 W	100 W	on/off	199 mm	63 mm	36 mm
17225000	1 W	150 W	on/off	219 mm	63 mm	36 mm
17226000	1 W	240 W	on/off	244 mm	71 mm	38 mm
17227000	1 W	320 W	on/off	252 mm	90 mm	44 mm
17228000	1 W	480 W	on/off	262 mm	125 mm	44 mm
17230000	5 W	30 W	Trailing-edge phase	145 mm	50 mm	22 mm
17231000	12 W	75 W	Trailing-edge phase	185 mm	60 mm	31 mm
17232000	12 W	120 W	Trailing-edge phase	223 mm	64 mm	32 mm
17240000	1 W	20 W	on/off	150 mm	40 mm	30 mm
17241000	1 W	40 W	on/off	210 mm	40 mm	30 mm
17242000	1 W	60 W	on/off	250 mm	40 mm	30 mm
17243000	1 W	120 W	on/off	300 mm	40 mm	30 mm
17244000	1 W	150 W	on/off	310 mm	40 mm	30 mm
17250000	1 W	45 W	DALI-2	187 mm	45 mm	31 mm
17251000	1 W	80 W	DALI-2	290 mm	45 mm	31 mm
17252000	1 W	150 W	DALI-2	290 mm	45 mm	31 mm
17260000	1 W	150 W	on/off	105 mm	90 mm	59 mm

Compatible Controller						
Article no.	Power min	Power	Control	Length	Width	Height
17502000	1 W	120 W	DALI	183 mm	33 mm	23 mm
18151000	1 W	240 W	KNX	170 mm	59 mm	30 mm
18152000	1 W	240 W	DALI-DT6	170 mm	59 mm	30 mm
18153000	1 W	240 W	DMX	170 mm	59 mm	30 mm
18154000	1 W	240 W	1-10 V	170 mm	59 mm	30 mm
18161000	1 W	240 W	KNX	72 mm	90 mm	70 mm
18162000	1 W	240 W	DALI-DT6	54 mm	110 mm	66 mm
18164000	1 W	240 W	1-10 V	54 mm	110 mm	66 mm
17528000	1 W	240 W	Wireless technology control			
17511000	1 W	240 W	Wireless technology control	145 mm	46.5 mm	16 mm
18157000	1 W	240 W	ZigBee	145 mm	46.5 mm	16 mm
18192000	1 W	240 W	Wireless technology control	160 mm	45 mm	18 mm

**QUALITYFLEX Protection Horizon Segment LED Flex lighting 50 m,**  
**CRI > 90, 5 W / m, IP67**  
Article no. 76582004

Light.  
For Generations.

Compatible Profiles				
	Series name	Length	Width	Hight
53581260	QUALITYFLEX Protection Ho- rizon	1,000 mm	17.5 mm	22.9 mm
53582260	QUALITYFLEX Protection Ho- rizon	514 mm	13.5 mm	18 mm