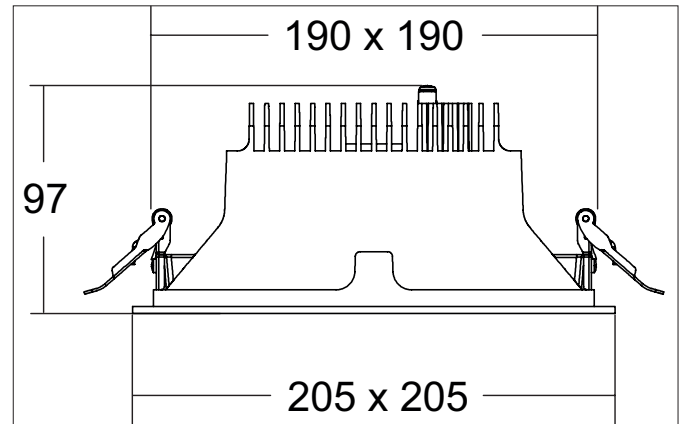

APOLLO MAXI LED downlight, square, on/off switchable

Article no. 41644165

Light.
For Generations.**Tender**

LED downlight, square, on/off switchable, Square. Toolless ceiling installation by installation springs. Ceiling cut-out L x W 190 x 190 mm, Installation depth 97 mm, Length 205 mm, Width 205 mm, Weight 0,800 kg, Reflector silver with rotationssymmetrical, deep, wide distributed light intensity. optimal light distribution due to a plastic, transparent cover. Luminous flux 2.655 lm, Power 1 x 20,5 W, Light colour neutral white, Correlated color temperature (CCT) 3.500 K, Colour rendering index CRI > 90, Rated life time L80/B10 at 25 °C: 50.000 h, Rated life time L80/B50 at 25 °C: 50.000 h, Housing material: Aluminium / Glass / Plastic, Colour: Silver structure, Permissible ambient temperature (ta): -20 °C - +25 °C, Protection class (EN 61140): II, Degree of protection (DIN EN 60529): IP20, .With electronic driver, on/off switchable.

Article data	
Article no.	41644165
GTIN	4251433989363
Series name	APOLLO MAXI
Short description	LED downlight, square, on/off switchable
Material	Aluminium / Glass / Plastic
Colour	Silver
Type of surface	Structure
Shape	Square
Built-in width	190 mm
Built-in length	190 mm
Installation depth	97 mm
Length	205 mm
Width	205 mm
Weight	0.800 kg

APOLLO MAXI LED downlight, square, on/off switchable

Article no. 41644165

Light.
For Generations.

Lighting technology	
Colour temperature	3.500 K
Light colour	White
Light output	Direct
Luminous flux	2,655 lm
System efficiency	130 lm/W
Colour rendering	CRI > 90
Reflector	Faceted
Reflector colour	silver
Beam angle	55°
Light sharing	Symmetric
Adjustable color temperature	No

Operating technology of the luminaire	
System output	20.5 W
Voltage type	AC
AC nominal voltage max	230 V
Frequency max	50 Hz
Lamp	LED
Lamp holder	Without fitting
Protection class	II
Degree of protection	IP20
Control	on/off
Bulb change possible	The light source of this luminaire may only be replaced by the manufacturer or a service technician commissioned by him or a similarly qualified person.
Rated life time L80/B10 at 25 °C	50.000 h
Rated life time L80/B50 at 25 °C	50.000 h

Mounting technology	
Mounting method	Recessed mounting
Place of installation	Ceiling-mounted
Adjustability	Not adjustable
stamp	UKCA
Further references	No cover with thermal insulation material
Material cover	Plastic, transparent
Suitable for through-wiring	No

Packing data	
Gross weight	0.87 kg
Length of packaging	205 mm
Packaging width	205 mm
Packaging height	97 mm
Disposal at end of life	This product must not be disposed of with household waste. You are obliged, to dispose of such electrical waste separately. By disposing of electrical waste and other old or defective electronics separately, you support recycling or other forms of re-use. In that way you help to take care and to avoid that harmful substances get into the environment.

Required accessories	