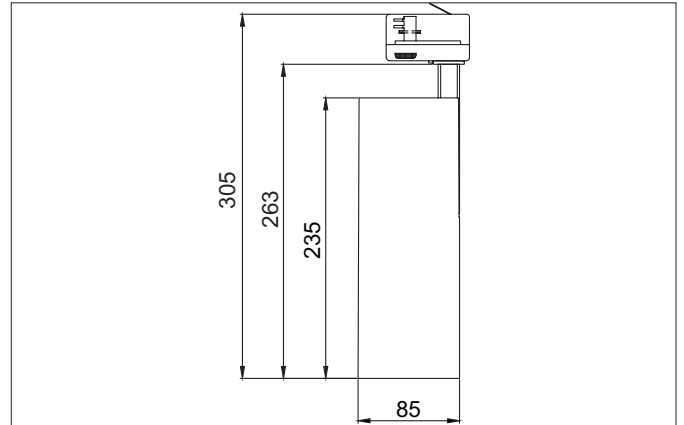

**MAXI LED track spotlight**

Article no. 88398684

Light.  
For Generations.**Tender**

LED track spotlight, Round., Hight 263.0 mm Weight 1.0 kg, with rotattionssymmetrical, deep, wide distributed light intensity. Power 1 x 32 W, Light colour neutral white, Correlated color temprature (CCT) 4.000 K, Colour rendering index CRI > 90, Housing material: Aluminium / Glass / Plastic, Colour: White structure, Permissible ambient temperature (ta): -20 °C - +25 °C, Protection class (EN 61140): I, Degree of protection (DIN EN 60529): IP20, .With electronic driver, DALI dimmable.

Article data	
Article no.	88398684
GTIN	4251433980865
Series name	MAXI
Short description	LED track spotlight
Material	Aluminium / Glass / Plastic
Colour	White
Type of surface	Structure
Shape	Round
Length	235 mm
Hight	263 mm
Weight	1.000 kg

**MAXI LED track spotlight**

Article no. 88398684

Light.  
For Generations.

Lighting technology	
Colour temperature	4.000 K
Light colour	White
System efficiency	32 lm/W
Colour rendering	CRI > 90
Reflector	High-gloss
Light sharing	Symmetric
Adjustable color temperature	No

Operating technology of the luminaire	
System output	32 W
Voltage type	AC
AC nominal voltage max	230 V
Frequenz max.	50 Hz
Lamp	LED
Lamp holder	Without fitting
Protection class	I
Degree of protection	IP20
Control	DALI
Bulb change possible	The light source of this luminaire may only be replaced by the manufacturer or a service technician commissioned by him or a similarly qualified person.

Mounting technology	
Mounting method	Conductor rail mounting
Place of installation	Ceiling-mounted
Adjustability	Rotatable and adjustable head
Swivel angle	180°
Rotation angle	355°
Head adjustable angle	180°
Suitable for through-wiring	No

Packing data	
Gross weight	1.02 kg
Length of packaging	290 mm
Packaging width	110 mm
Packaging height	170 mm
Disposal at end of life	This product must not be disposed of with household waste. You are obliged, to dispose of such electrical waste separately. By disposing of electrical waste and other old or defective electronics separately, you support recycling or other forms of re-use. In that way you help to take care and to avoid that harmful substances get into the environment.