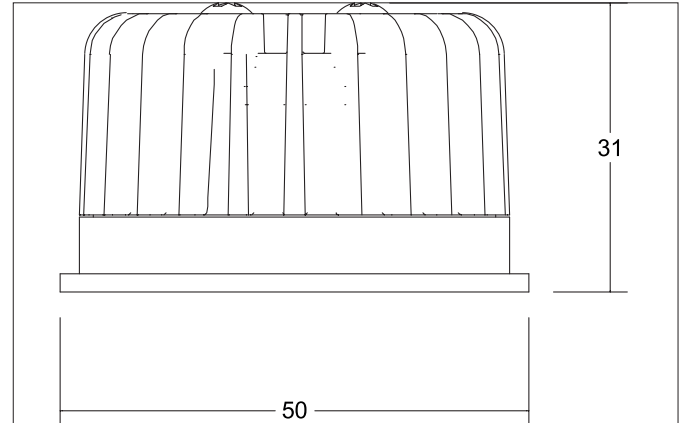

**DISC LED insert, MR16, 6 W, with lens optics, 350 mA**  
Article no. 12920003Light.  
For Generations.**Tender**

LED insert, MR16, 6 W, with lens optics, 350 mA, , Round.Lamp holder: Plug&Play, Material: Aluminium / Plastic, Degree of protection: according to DIN EN 60529 IP20, Protection class: (EN 61140) III, Current: 350 mA, Power: 6 W, Amount of light sources / fittings: 1 Qty, Luminous flux : 670 lm, Colour temperature: 3.000 K, Light colour: White, Beam angle: 38°, Control: Depending on driver.

Article data	
Article no.	12920003
GTIN	4251433922902
Series name	DISC
Short description	LED insert, MR16, 6 W, with lens optics, 350 mA
Material	Aluminium / Plastic
Shape	Round
Outer diameter	50 mm
Hight	31 mm
Weight	0.061 kg

Lighting technology	
Colour temperature	3.000 K
Light colour	White
Luminous flux	670 lm
Colour rendering	CRI > 80
Luminaire optics	Lens
Beam angle	38°
Light sharing	Symmetric

**DISC LED insert, MR16, 6 W, with lens optics, 350 mA**

Article no. 12920003







Light.  
For Generations.

Operating technology of the luminaire	
System output	6 W
Voltage type	DC
Current	350 mA
Lamp	LED
Lamp holder	Plug&Play
Protection class	III
Degree of protection	IP20
Control	Depending on driver
Bulb change possible	The light source of this luminaire may only be replaced by the manufacturer or a service technician commissioned by him or a similarly qualified person.
Rated life time L80/B20 at 25 °C	50.000 h

Packing data	
Gross weight	0.072 kg
Length of packaging	55 mm
Packaging width	55 mm
Packaging height	65 mm
Disposal at end of life	This product must not be disposed of with household waste. You are obliged, to dispose of such electrical waste separately. By disposing of electrical waste and other old or defective electronics separately, you support recycling or other forms of re-use. In that way you help to take care and to avoid that harmful substances get into the environment.

**DISC LED insert, MR16, 6 W, with lens optics, 350 mA**  
 Article no. 12920003

Light.  
 For Generations.

Required accessories	
	LED converter 350 mA, on/off switchable Power: 1 - 7,2 W Dimensions: 68 mm x 35 mm x 21 mm
	LED converter 350 mA, on/off switchable Power: 1 - 15 W Dimensions: 115 mm x 34 mm x 19 mm
	LED converter 350 mA, on/off switchable Power: 1 - 21 W Dimensions: 128 mm x 50 mm x 13 mm
	LED converter 350 mA, trailing-edge phase dimmable Power: 2,8 - 7 W Dimensions: 110 mm x 50 mm x 19 mm
	LED-round converter 350 mA, trailing-edge phase dimmer Power: 4,9 - 7 W Dimensions: 51 mm x 24 mm
	LED converter 350 mA, trailing-edge phase dimmable Power: 10,2 - 14 W Dimensions: 125 mm x 51 mm x 20 mm
	LED converter 350 mA, 1-10 V dimmable (analog) Power: 5,2 - 18 W Dimensions: 110 mm x 52 mm x 22 mm
	LED converter 350 mA, DALI dimmable (digital) Power: 3,5 - 17 W Dimensions: 110 mm x 52 mm x 22 mm
	LED converter 350 mA, trailing-edge phase dimmable Power: 4,2 - 10 W Dimensions: 102 mm x 38 mm x 21 mm
	LED converter 350 mA, trailing-edge phase dimmable Power: 8,8 - 18 W Dimensions: 110 mm x 52 mm x 22 mm