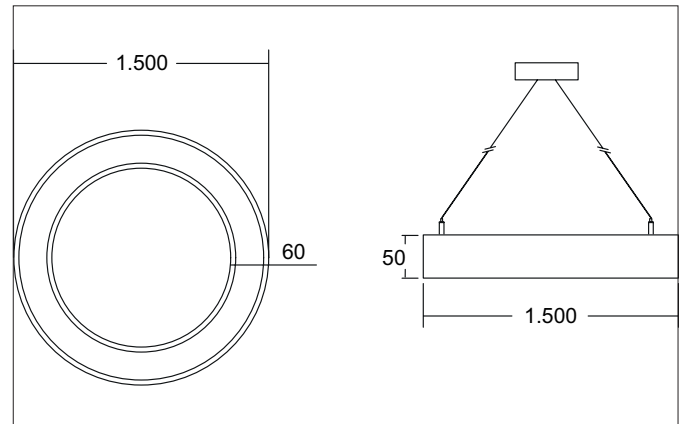

BIRO CIRCLE LED pendant ring luminaire, direct/indirect, dimmable

Article no. 13854184

Light.
For Generations.**Tender**

LED pendant ring luminaire, direct/indirect, dimmable, Round. Luminaire diameter 1500.0 mm, Height 50.0 mm, for pendulum mounting. Pendulum length max. 5000.0 mm Weight 12.0 kg, with rotationssymmetrical, deep, wide distributed light intensity. optimal light distribution due to a plastic, opal cover. Luminous flux 18.253 lm, Power 1 x 147 W, Light colour neutral white, Correlated color temperature (CCT) 4.000 K, Colour rendering index CRI > 80, Rated life time L70/B50 at 25 °C: 276.000 h, Rated life time L80/B20 at 25 °C: 153.000 h, Housing material: Aluminium / Steel / Plastic, Colour: Black structure, Permissible ambient temperature (ta): -20 °C - +25 °C, Protection class (EN 61140): I, Degree of protection (DIN EN 60529): IP20, .With electronic driver, DALI dimmable.

Article data	
Article no.	13854184
GTIN	4251433968344
Series name	BIRO CIRCLE
Short description	LED pendant ring luminaire, direct/indirect, dimmable
Material	Aluminium / Steel / Plastic
Colour	Black
Type of surface	Structure
Shape	Round
Outer diameter	1500 mm
Height	50 mm
Scope of delivery	incl. converter for connection to 230 V mains voltage
Weight	12.000 kg

BIRO CIRCLE LED pendant ring luminaire, direct/indirect, dimmable

Article no. 13854184

Light.
For Generations.

Lighting technology	
Colour temperature	4.000 K
Light colour	White
Light output	Direct/Indirect
Luminous flux	18,253 lm
Luminous flux component (direct / indirect)	70/30 %
System efficiency	124 lm/W
McAdam-Step	McAdam-Step 3
Colour rendering	CRI > 80
Reflector	Without
Beam angle	110°
Light sharing	Symmetric
Adjustable color temperature	No

Operating technology of the luminaire	
System output	147 W
Voltage type	AC
AC nominal voltage max	230 V
Frequenz max.	50 Hz
Lamp	LED
Lamp holder	Without fitting
Protection class	I
Degree of protection	IP20
Control	DALI
Bulb change possible	The light source of this luminaire may only be replaced by the manufacturer or a service technician commissioned by him or a similarly qualified person.
Rated life time L70/B50 at 25 °C	276,000 h
Rated life time L80/B20 at 25 °C	153.000 h
Rated life time L90/B10 at 25 °C	74.000 h

Mounting technology	
Mounting method	Suspended
Place of installation	Ceiling-mounted
Adjustability	Not adjustable
stamp	UKCA
Pendulum length max.	5,000 mm
Material cover	Plastic, opal
Number of cable suspensions	5

Packing data	
Gross weight	14 kg
Length of packaging	1,530 mm
Packaging width	1,530 mm
Packaging height	60 mm
Disposal at end of life	This product must not be disposed of with household waste. You are obliged, to dispose of such electrical waste separately. By disposing of electrical waste and other old or defective electronics separately, you support recycling or other forms of re-use. In that way you help to take care and to avoid that harmful substances get into the environment.