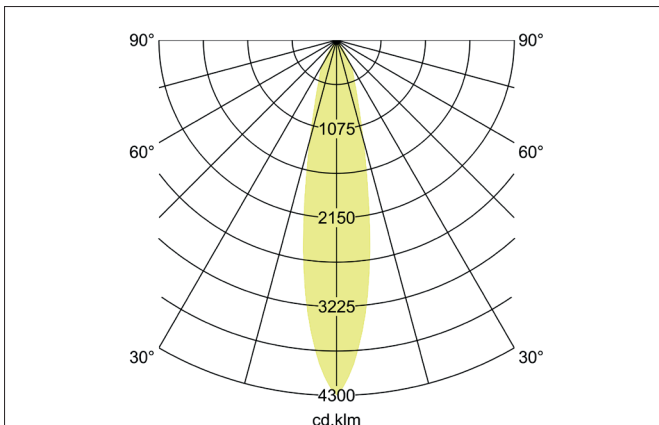
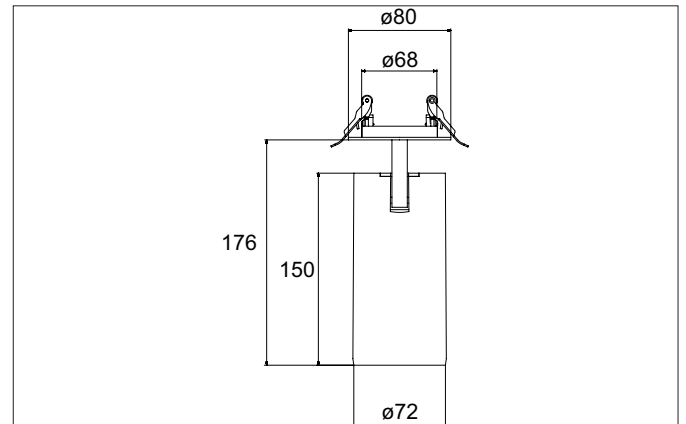

**TRAXX MAXI LED semi-recessed spotlight, on/off switchable**

Article no. 88802163

Light.  
For Generations.**Tender**

LED semi-recessed spotlight, on/off switchable, Round. Ceiling cut-out  $\varnothing$  68 mm, Installation depth 50 mm, Weight 0,600 kg, with rotattionssymmetrical, deep, wide distributed light intensity. optimal light distribution due to a glass transparent cover. Luminous flux 2.943 lm, Power 1 x 24 W, Light colour warm white, Correlated color temprature (CCT) 3.000 K, Colour rendering index CRI > 90, Rated life time L80/B50 at 25 °C: 50.000 h, Housing material: Aluminium, Colour: Silver structure, Permissible ambient temperature (ta): -20 °C - +25 °C, Protection class (EN 61140): II, Degree of protection (DIN EN 60529): IP20, .With electronic driver, on/off switchable.

Article data	
Article no.	88802163
GTIN	4251433972570
Series name	TRAXX MAXI
Short description	LED semi-recessed spotlight, on/off switchable
Material	Aluminium
Colour	Silver
Type of surface	Structure
Shape	Round
Built-in diameter	68 mm
Installation depth	50 mm
Weight	0.600 kg

**TRAXX MAXI LED semi-recessed spotlight, on/off switchable**

Article no. 88802163

Light.  
For Generations.

Lighting technology	
Colour temperature	3.000 K
Light colour	White
Light output	Direct
Luminous flux	2,943 lm
System efficiency	123 lm/W
Colour rendering	CRI > 90
Reflector	High-gloss
Beam angle	20°
Light sharing	Symmetric
Adjustable color temperature	No

Operating technology of the luminaire	
System output	24 W
Voltage type	AC
AC nominal voltage max	230 V
Frequency max	50 Hz
Lamp	LED
Protection class	II
Degree of protection	IP20
Control	on/off
Bulb change possible	The light source of this luminaire may only be replaced by the manufacturer or a service technician commissioned by him or a similarly qualified person.
Rated life time L80/B50 at 25 °C	50.000 h

Mounting technology	
Mounting method	Recessed mounting
Place of installation	Ceiling-mounted
Adjustability	Rotable and pivoted
Swivel angle	90°
Rotation angle	350°
Head adjustable angle	90°
stamp	UKCA
Further references	No cover with thermal insulation material
Material cover	Glass transparent
Suitable for through-wiring	No

Packing data	
Gross weight	0.67 kg
Length of packaging	71 mm
Packaging width	71 mm
Packaging height	220 mm
Disposal at end of life	This product must not be disposed of with household waste. You are obliged, to dispose of such electrical waste separately. By disposing of electrical waste and other old or defective electronics separately, you support recycling or other forms of re-use. In that way you help to take care and to avoid that harmful substances get into the environment.