

**MAIGA-S LED recessed spot, IP65, dim2warm**  
Article no. 12445253

Light.  
For Generations.

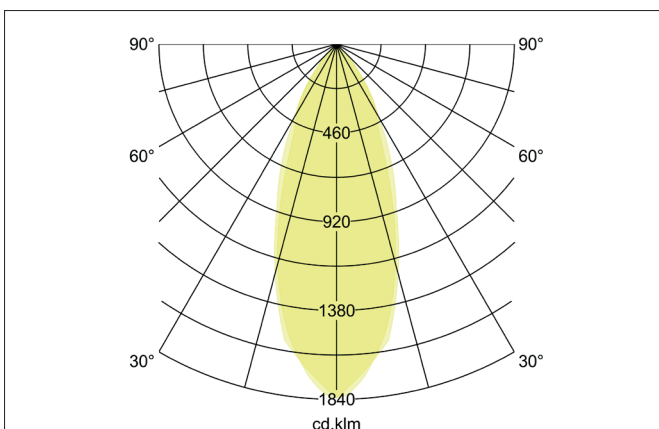
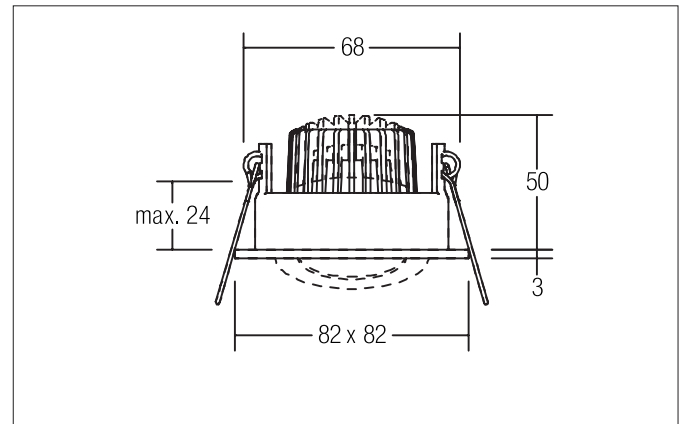

**Tender**

LED recessed spot, IP65, dim2warm, Square. Toolless ceiling installation by installation springs. Ceiling cut-out Ø 68 mm, Installation depth 50 mm, Length 82 mm, Width 82 mm, Weight 0,177 kg, Reflector silver with rotationssymmetrical, deep, wide distributed light intensity. optimal light distribution due to a plastic, transparent cover. Luminous flux 460 lm, Power 1 x 6 W, Light colour warm white to StructureNo-delmpl 4028e4bd62d2f56b01637350923b3e28, Correlated color temperature (CCT) 3.000 - 1.800 K, Colour rendering index CRI > 90, Housing material: Aluminium / Steel / Silicone rubber / Plastic, Colour: Alu, Permissible ambient temperature (ta): -20 °C - +25 °C, Protection class (EN 61140): III, Degree of protection (DIN EN 60529): IP65 when installing in closed ceilings, .For connection to an external driver, which is not included in the scope of delivery of the luminaire. Depending on driver dimmable.

**MAIGA-S LED recessed spot, IP65, dim2warm**

Article no. 12445253

Light.  
For Generations.

| Article data       |                                               |
|--------------------|-----------------------------------------------|
| Article no.        | 12445253                                      |
| GTIN               | 4251433914396                                 |
| Series name        | MAIGA-S                                       |
| Short description  | LED recessed spot, IP65, dim2warm             |
| Material           | Aluminium / Steel / Silicone rubber / Plastic |
| Colour             | Alu                                           |
| Type of surface    | Matt                                          |
| Shape              | Square                                        |
| Built-in diameter  | 68 mm                                         |
| Installation depth | 50 mm                                         |
| Length             | 82 mm                                         |
| Width              | 82 mm                                         |
| Hight              | 3 mm                                          |
| Weight             | 0.177 kg                                      |
| stamp              | UKCA                                          |
| Conformance        | CE, UKCA                                      |

| Lighting technology          |                   |
|------------------------------|-------------------|
| Colour temperature           | 3.000 K - 1.800 K |
| Light colour                 | White             |
| Light output                 | Direct            |
| Luminous flux                | 460 lm            |
| System efficiency            | 77 lm/W           |
| Colour rendering             | CRI > 90          |
| Reflector                    | High-gloss        |
| Reflector colour             | silver            |
| Beam angle                   | 38°               |
| Light sharing                | Symmetric         |
| Adjustable color temperature | Infinite control  |

| Operating technology of the luminaire |                                                                                                                                                          |
|---------------------------------------|----------------------------------------------------------------------------------------------------------------------------------------------------------|
| System output                         | 6 W                                                                                                                                                      |
| Voltage type                          | DC                                                                                                                                                       |
| Current                               | 350 mA                                                                                                                                                   |
| Lamp                                  | LED                                                                                                                                                      |
| Lamp holder                           | Plug&Play                                                                                                                                                |
| Protection class                      | III                                                                                                                                                      |
| Degree of protection                  | IP65                                                                                                                                                     |
| Protection class on the ceiling side  | IP20                                                                                                                                                     |
| Dimmable                              | Depending on type of control gear                                                                                                                        |
| Control                               | Depending on driver                                                                                                                                      |
| Bulb change possible                  | The light source of this luminaire may only be replaced by the manufacturer or a service technician commissioned by him or a similarly qualified person. |

| Mounting technology    |                                           |
|------------------------|-------------------------------------------|
| Mounting method        | Recessed mounting                         |
| Place of installation  | Ceiling-mounted                           |
| Adjustability          | Pivoted                                   |
| Swivel angle           | 30°                                       |
| Max. ceiling thickness | 24 mm                                     |
| Further references     | No cover with thermal insulation material |
| Material cover         | Plastic, transparent                      |

**MAIGA-S LED recessed spot, IP65, dim2warm**

Article no. 12445253











Light.  
For Generations.

| Packing data            |                                                                                                                                                                                                                                                                                                                                                                                |
|-------------------------|--------------------------------------------------------------------------------------------------------------------------------------------------------------------------------------------------------------------------------------------------------------------------------------------------------------------------------------------------------------------------------|
| Gross weight            | 0.209 kg                                                                                                                                                                                                                                                                                                                                                                       |
| Length of packaging     | 105 mm                                                                                                                                                                                                                                                                                                                                                                         |
| Packaging width         | 60 mm                                                                                                                                                                                                                                                                                                                                                                          |
| Packaging height        | 90 mm                                                                                                                                                                                                                                                                                                                                                                          |
| Disposal at end of life | <p>This product must not be disposed of with household waste. You are obliged, to dispose of such electrical waste separately.</p> <p>By disposing of electrical waste and other old or defective electronics separately, you support recycling or other forms of re-use. In that way you help to take care and to avoid that harmful substances get into the environment.</p> |

**MAIGA-S LED recessed spot, IP65, dim2warm**

Article no. 12445253

Light.  
For Generations.

| Accessories                                                                         |                                                                                                                                        |
|-------------------------------------------------------------------------------------|----------------------------------------------------------------------------------------------------------------------------------------|
|    | Article no.: 17663000<br>LED converter 350 mA, trailing-edge phase dimmable<br>Power: 2,8 - 7 W<br>Dimensions: 110 mm x 50 mm x 19 mm  |
|    | Article no.: 17663010<br>LED converter 350 mA, trailing-edge phase dimmable<br>Power: 2,8 - 7 W<br>Dimensions: 110 mm x 50 mm x 19 mm  |
|    | Article no.: 17663020<br>LED converter 350 mA, trailing-edge phase dimmable<br>Power: 2,8 - 7 W<br>Dimensions: 110 mm x 50 mm x 19 mm  |
|    | Article no.: 17652000<br>LED-round converter 350 mA, trailing-edge phase dimmer<br>Power: 4,9 - 7 W<br>Dimensions: 51 mm x 24 mm       |
|   | Article no.: 17652020<br>LED-round converter 350 mA, trailing-edge phase dimmer<br>Power: 4,9 - 7 W<br>Dimensions: 51 mm x 24 mm       |
|  | Article no.: 17640000<br>LED converter 350 mA, trailing-edge phase dimmable<br>Power: 4,2 - 10 W<br>Dimensions: 102 mm x 38 mm x 21 mm |
|  | Article no.: 17640010<br>LED converter 350 mA, trailing-edge phase dimmable<br>Power: 4,2 - 10 W<br>Dimensions: 102 mm x 38 mm x 21 mm |
|  | Article no.: 17640020<br>LED converter 350 mA, trailing-edge phase dimmable<br>Power: 4,2 - 10 W<br>Dimensions: 102 mm x 38 mm x 21 mm |
|  | Article no.: 17657000<br>LED converter 350 mA, 1-10 V dimmable (analog)<br>Power: 5,2 - 18 W<br>Dimensions: 110 mm x 52 mm x 22 mm     |
|  | Article no.: 17657010<br>LED converter 350 mA, 1-10 V dimmable (analog)<br>Power: 5,2 - 18 W<br>Dimensions: 110 mm x 52 mm x 22 mm     |

**MAIGA-S LED recessed spot, IP65, dim2warm**

Article no. 12445253

Light.  
For Generations.

| Accessories                                                                         |                                                                                                                                   |
|-------------------------------------------------------------------------------------|-----------------------------------------------------------------------------------------------------------------------------------|
|    | Article no.: 17684000<br>LED converter 350 mA, DALI dimmable (digital)<br>Power: 2,8 - 7 W<br>Dimensions: 130 mm x 42 mm x 22 mm  |
|    | Article no.: 17684010<br>LED converter 350 mA, DALI dimmable (digital)<br>Power: 2,8 - 7 W<br>Dimensions: 130 mm x 42 mm x 22 mm  |
|    | Article no.: 17684020<br>LED converter 350 mA, DALI dimmable (digital)<br>Power: 2,8 - 7 W<br>Dimensions: 130 mm x 42 mm x 22 mm  |
|    | Article no.: 17658000<br>LED round converter 350 mA, DALI dimmable (digital)<br>Power: 2,1 - 9 W<br>Dimensions: 56 mm x 25 mm     |
|   | Article no.: 17658010<br>LED round converter 350 mA, DALI dimmable (digital)<br>Power: 2,1 - 9 W<br>Dimensions: 56 mm x 25 mm     |
|  | Article no.: 17658020<br>LED round converter 350 mA, DALI dimmable (digital)<br>Power: 2,1 - 9 W<br>Dimensions: 56 mm x 25 mm     |
|  | Article no.: 17683000<br>LED converter 350 mA, DALI dimmable (digital)<br>Power: 3,5 - 17 W<br>Dimensions: 110 mm x 52 mm x 22 mm |
|  | Article no.: 17683010<br>LED converter 350 mA, DALI dimmable (digital)<br>Power: 3,5 - 17 W<br>Dimensions: 110 mm x 52 mm x 22 mm |
|  | Article no.: 17683020<br>LED converter 350 mA, DALI dimmable (digital)<br>Power: 3,5 - 17 W<br>Dimensions: 110 mm x 52 mm x 22 mm |
|  | Article no.: 17671000<br>LED converter 350mA, ZigBee dimmable<br>Power: 3,5 - 18,5 W<br>Dimensions: 146 mm x 44 mm x 30 mm        |
|  | Article no.: 17671010<br>LED converter 350mA, ZigBee dimmable<br>Power: 3,5 - 18,5 W<br>Dimensions: 146 mm x 44 mm x 30 mm        |

**MAIGA-S LED recessed spot, IP65, dim2warm**

Article no. 12445253

Light.  
For Generations.

| Accessories                                                                         |                                                                                                                                      |
|-------------------------------------------------------------------------------------|--------------------------------------------------------------------------------------------------------------------------------------|
|    | <p>Article no.: 17671020<br/>LED converter 350mA, ZigBee dimmable<br/>Power: 3,5 - 18,5 W<br/>Dimensions: 146 mm x 44 mm x 30 mm</p> |
|    | <p>Article no.: 17672000<br/>LED converter 350mA, Casambi dimmable<br/>Power: 3,5 - 18 W<br/>Dimensions: 146 mm x 44 mm x 30 mm</p>  |
|    | <p>Article no.: 17672010<br/>LED converter 350mA, Casambi dimmable<br/>Power: 3,5 - 18 W<br/>Dimensions: 146 mm x 44 mm x 30 mm</p>  |
|    | <p>Article no.: 17672020<br/>LED converter 350mA, Casambi dimmable<br/>Power: 3,5 - 18 W<br/>Dimensions: 146 mm x 44 mm x 30 mm</p>  |
|   | <p>Article no.: 3835<br/>Plug &amp; Play extension lead 350 mA<br/>Dimensions: 500 mm</p>                                            |
|  | <p>Article no.: 3836<br/>Plug &amp; Play extension lead 350 mA<br/>Dimensions: 1,000 mm</p>                                          |
|  | <p>Article no.: 3837<br/>Plug &amp; Play extension lead 350 mA<br/>Dimensions: 2,000 mm</p>                                          |