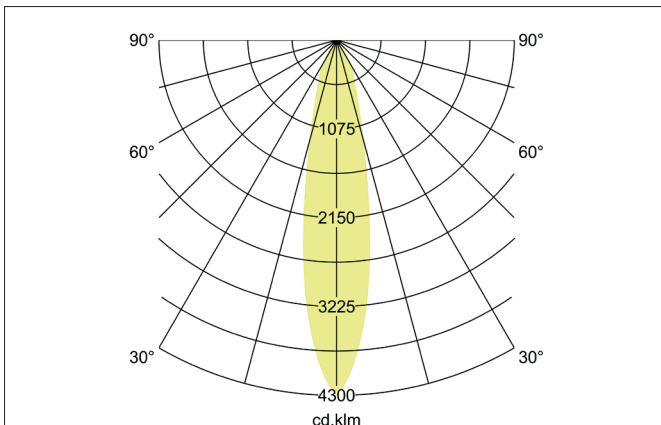
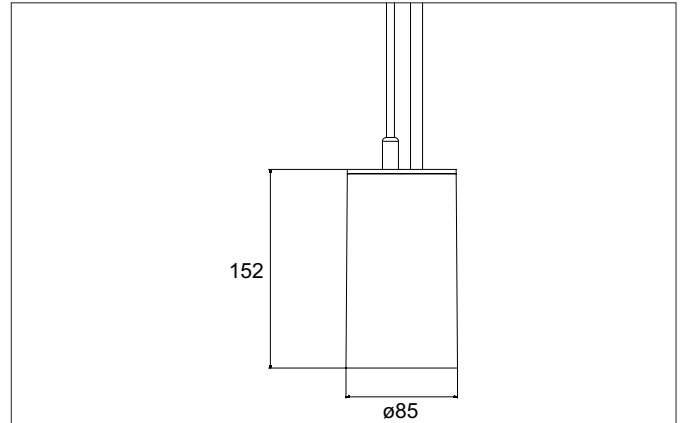

TRAXX MAXI LED pendant luminaire, on/off switchable

Article no. 88882164

Light.
For Generations.**Tender**

LED pendant luminaire, on/off switchable, Round., Hight 163.0 mm, for pendulum mounting. Pendulum length max. 1500.0 mm Weight 0.914 kg, with rotationssymmetrical, deep, wide distributed light intensity. optimal light distribution due to a glass transparent cover. Luminous flux 3.589 lm, Power 1 x 28 W, Light colour neutral white, Correlated color temprature (CCT) 4.000 K, Colour rendering index CRI > 90, Rated life time L80/B50 at 25 °C: 50.000 h, Housing material: Aluminium / Glass / Plastic, Colour: Silver structure, Permissible ambient temperature (ta): -20 °C - +25 °C, Protection class (EN 61140): I, Degree of protection (DIN EN 60529): IP20, .With electronic driver, on/off switchable.

| Article data | |
|-------------------|--|
| Article no. | 88882164 |
| GTIN | 4251433979241 |
| Series name | TRAXX MAXI |
| Short description | LED pendant luminaire, on/off switchable |
| Material | Aluminium / Glass / Plastic |
| Colour | Silver |
| Type of surface | Structure |
| Shape | Round |
| Hight | 163 mm |
| Weight | 0.914 kg |

TRAXX MAXI LED pendant luminaire, on/off switchable

Article no. 88882164

Light.
For Generations.

| Lighting technology | |
|------------------------------|---------------|
| Colour temperature | 4.000 K |
| Light colour | White |
| Light output | Direct |
| Luminous flux | 3,589 lm |
| System efficiency | 128 lm/W |
| McAdam-Step | McAdam-Step 3 |
| Colour rendering | CRI > 90 |
| Reflector | High-gloss |
| Beam angle | 20° |
| Light sharing | Symmetric |
| Adjustable color temperature | No |

| Operating technology of the luminaire | |
|---------------------------------------|--|
| System output | 28 W |
| Voltage type | AC |
| AC nominal voltage max | 230 V |
| Frequenz max. | 50 Hz |
| Lamp | LED |
| Lamp holder | Without fitting |
| Protection class | I |
| Degree of protection | IP20 |
| Control | on/off |
| Bulb change possible | The light source of this luminaire may only be replaced by the manufacturer or a service technician commissioned by him or a similarly qualified person. |
| Rated life time L80/B50 at 25 °C | 50.000 h |

| Mounting technology | |
|-----------------------------|-------------------|
| Mounting method | Suspended |
| Place of installation | Ceiling-mounted |
| Adjustability | Not adjustable |
| stamp | UKCA |
| Pendulum length max. | 1,500 mm |
| Material cover | Glass transparent |
| Suitable for through-wiring | No |

| Packing data | |
|-------------------------|---|
| Gross weight | 0.98 kg |
| Length of packaging | 170 mm |
| Packaging width | 170 mm |
| Packaging height | 110 mm |
| Disposal at end of life | This product must not be disposed of with household waste. You are obliged, to dispose of such electrical waste separately. By disposing of electrical waste and other old or defective electronics separately, you support recycling or other forms of re-use. In that way you help to take care and to avoid that harmful substances get into the environment. |