

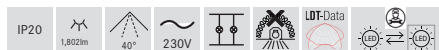
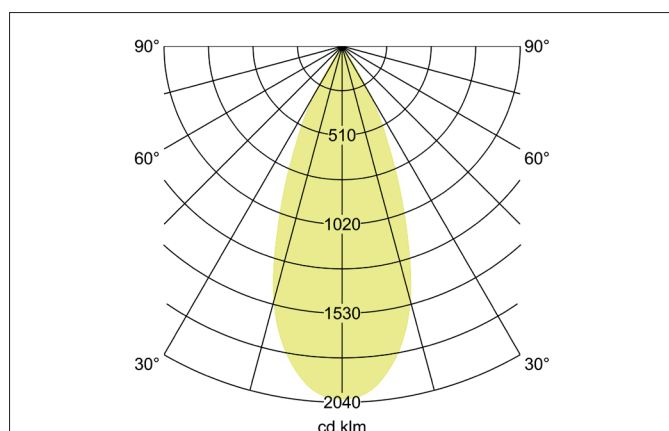
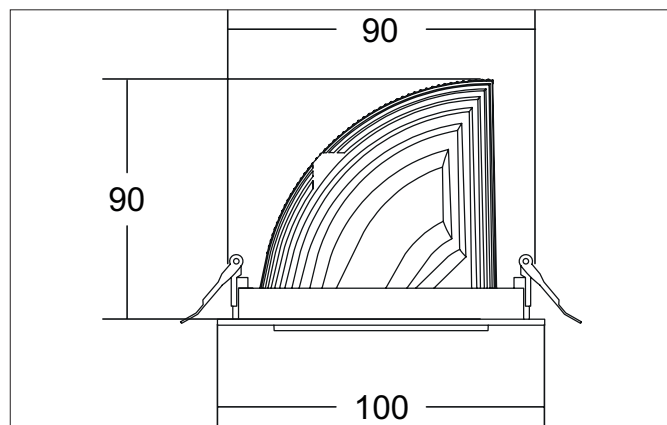

ARTEMIS MICRO LED recessed spotlight, DALI

Article no. 88244164DA

Tender

Round LED recessed spotlight, rotatable and tiltable, DALI dimmable, silver reflector, faceted, ceiling cut-out Ø 90 mm, installation depth 90 mm, outer diameter 100 mm, weight 0.400 kg, with rotationally symmetrical wide/deep light distribution. Transparent glass cover, rated luminous flux 1,802 lm, rated wattage 1 x 15 W, neutral white light color, most similar color temperature (CCT) 4,000 K, general color rendering index CRI > 90, housing material: aluminum, color: textured silver, permissible ambient temperature (ta): -20 °C - +25 °C, protection class (EN 61140): II, degree of protection (DIN EN 60529): IP20. With electronic control gear, DALI-DT6 dimmable.

Article data	
Article no.	88244164DA
GTIN	4251433984634
Series name	ARTEMIS MICRO
Short description	LED recessed spotlight, DALI
Material	Aluminium
Colour	Silver
Type of surface	Structure
Shape	Round
Outer diameter	100 mm
Built-in diameter	90 mm
Installation depth	90 mm
Weight	0.400 kg
Conformance	CE, UKCA

ARTEMIS MICRO LED recessed spotlight, DALI

Article no. 88244164DA

Lighting technology	
Colour temperature	4.000 K
Light colour	White
Light output	Direct
Luminous flux	1,802 lm
System efficiency	120 lm/W
Colour rendering	CRI > 90
Reflector	High-gloss
Beam angle	40°
Light sharing	Symmetric
Adjustable color temperature	No

Operating technology of the luminaire	
Voltage type	AC
AC nominal voltage max	230 V
Frequency max	50 Hz
Lamp	LED
Protection class	II
Degree of protection	IP20
Control	DALI-DT6
Bulb change possible	The light source of this luminaire may only be replaced by the manufacturer or a service technician commissioned by him or a similarly qualified person.
Energy efficiency class	nicht erforderlich
max. no. lights on B16 A	130

Mounting technology	
Mounting method	Recessed mounting
Place of installation	Ceiling-mounted
Adjustability	Rotatable and adjustable head
Swivel angle	90°
Rotation angle	350°
Head adjustable angle	90°
Further references	No cover with thermal insulation material
Material cover	Glass transparent
Suitable for through-wiring	No

Packing data	
Gross weight	0.462 kg
Length of packaging	100 mm
Packaging width	100 mm
Packaging height	90 mm
Disposal at end of life	This product must not be disposed of with household waste. You are obliged, to dispose of such electrical waste separately. By disposing of electrical waste and other old or defective electronics separately, you support recycling or other forms of re-use. In that way you help to take care and to avoid that harmful substances get into the environment.