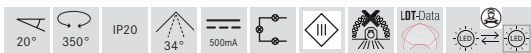
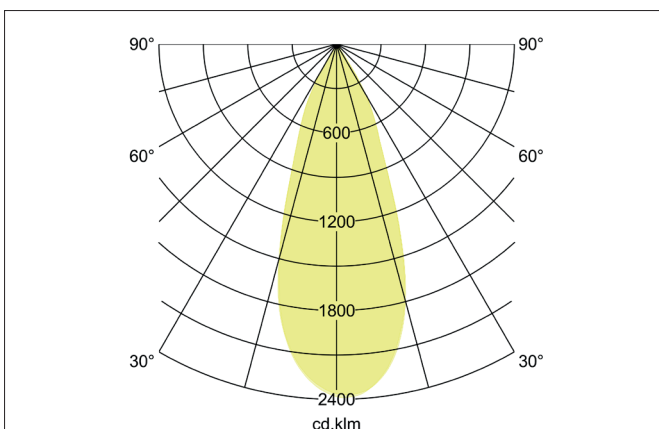
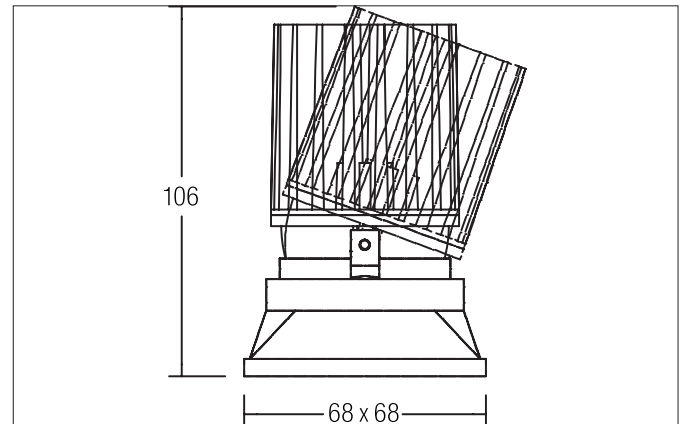
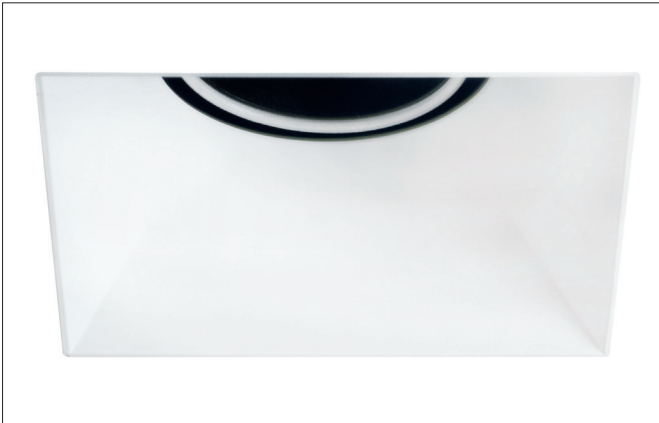

COUPLED-S LED-System-recessed spot, deepened

Article no. 12641079

Light.
For Generations.**Tender**

LED-System-recessed spot, deepened, Square. Ceiling cut-out Installation depth 106 mm, Length 68 mm, Width 68 mm, Weight 0,194 kg, Reflector silver with rotationssymmetrical, deep, wide distributed light intensity. optimal light distribution due to a plastic, transparent cover. Power 1 x 8,9 W, Light colour warm white to daylight white, Correlated color temprature (CCT) 2.700 - 6.500 K, Colour rendering index CRI > 90, Housing material: Aluminium / Plastic, Colour: White, Permissible ambient temperature (ta): -20 °C - +25 °C, Protection class (EN 61140): III, Degree of protection (DIN EN 60529): IP20, .For connection to an external driver, which is not included in the scope of delivery of the luminaire. Other dimmable.

Article data	
Article no.	12641079
GTIN	4251433945857
Series name	COUPLED-S
Short description	LED-System-recessed spot, deepened
Material	Aluminium / Plastic
Colour	White
Type of surface	Matt
Shape	Square
Installation depth	106 mm
Length	68 mm
Width	68 mm
Weight	0.194 kg
stamp	UKCA
Conformance	UKCA

COUPLED-S LED-System-recessed spot, deepened

Article no. 12641079

Light.
For Generations.

Lighting technology	
Colour temperature	2.700 K - 6.500 K
Light colour	White
Light output	Direct
System efficiency	9 lm/W
Colour rendering	CRI > 90
Reflector	High-gloss
Reflector colour	silver
Beam angle	34°
Light sharing	Symmetric
Adjustable color temperature	Infinite control

Operating technology of the luminaire	
Voltage type	DC
Current	500 mA
Lamp	LED
Protection class	III
Degree of protection	IP20
Dimmable	Depending on type of control gear
Control	Other
Bulb change possible	The light source of this luminaire may only be replaced by the manufacturer or a service technician commissioned by him or a similarly qualified person.





Mounting technology	
Mounting method	Recessed mounting
Place of installation	Ceiling-mounted
Adjustability	Rotable and pivoted
Swivel angle	20°
Rotation angle	350°
Further references	No cover with thermal insulation material
Material cover	Plastic, transparent

Packing data	
Gross weight	0.267 kg
Length of packaging	105 mm
Packaging width	105 mm
Packaging height	130 mm
Disposal at end of life	This product must not be disposed of with household waste. You are obliged, to dispose of such electrical waste separately. By disposing of electrical waste and other old or defective electronics separately, you support recycling or other forms of re-use. In that way you help to take care and to avoid that harmful substances get into the environment.

COUPLED-S LED-System-recessed spot, deepened

Article no. 12641079

Light.
For Generations.

Accessories	
	<p>Article no.: 17823010 LED converter 500 mA, on/off switchable Power: 1 - 22 W Dimensions: 146 mm x 43.5 mm x 30 mm</p>
	<p>Article no.: 17822010 LED converter 500 mA, trailing-edge phase dimmable Power: 8 - 20 W Dimensions: 110 mm x 52 mm x 22 mm</p>
	<p>Article no.: 17829010 LED converter 500 mA, trailing-edge phase dimmable Power: 1 - 24 W Dimensions: 166 mm x 46 mm x 34 mm</p>
	<p>Article no.: 17824010 LED converter 500 mA, 1-10V dimmable (analog) Power: 5 - 27 W Dimensions: 146 mm x 43.5 mm x 30 mm</p>
	<p>Article no.: 17826010 LED converter 500 mA, DALI dimmable (digital) Power: 5 - 27 W Dimensions: 146 mm x 44 mm x 30 mm</p>