

**TRAXX MIDI LED recessed spotlight, DALI**  
Article no. 88755184DA

Light.  
For Generations.

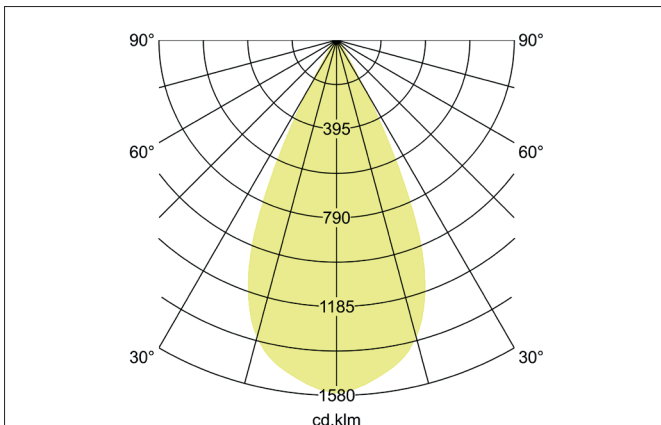
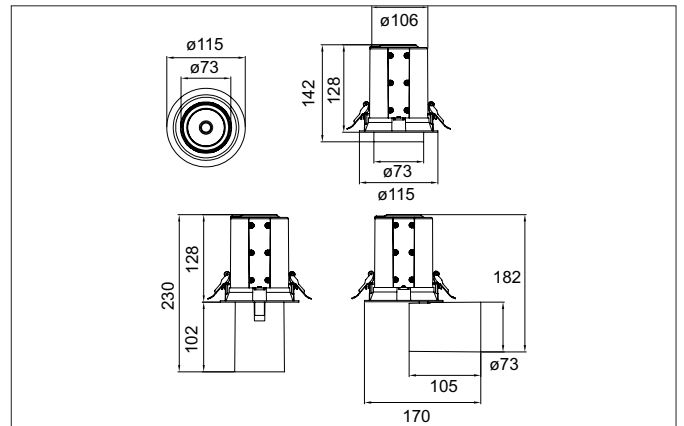

**Tender**

LED recessed spotlight, DALI, Round. Ceiling cut-out Ø 107 mm, Installation depth 128 mm, with rotationssymmetrical, deep, wide distributed light intensity. optimal light distribution due to a glass transparent cover. Luminous flux 2.708 lm, Power 1 x 20 W, Light colour neutral white, Correlated color temprature (CCT) 4.000 K, Colour rendering index CRI > 90, Rated life time L80/B50 at 25 °C: 50.000 h, Housing material: Aluminium / Glass / Plastic, Colour: Black structure, Permissible ambient temperature (ta): -20 °C - +25 °C, Protection class (EN 61140): II, Degree of protection (DIN EN 60529): IP20, .With electronic driver, DALI dimmable.

Article data	
Article no.	88755184DA
GTIN	4251433988182
Series name	TRAXX MIDI
Short description	LED recessed spotlight, DALI
Material	Aluminium / Glass / Plastic
Colour	Black
Type of surface	Structure
Shape	Round
Built-in diameter	107 mm
Installation depth	128 mm
Weight	N.N.

**TRAXX MIDI LED recessed spotlight, DALI**

Article no. 88755184DA

Light.  
For Generations.

Lighting technology	
Colour temperature	4.000 K
Light colour	White
Light output	Direct
Luminous flux	2,708 lm
System efficiency	135 lm/W
Colour rendering	CRI > 90
Reflector	High-gloss
Beam angle	50°
Light sharing	Symmetric

Operating technology of the luminaire	
System output	20 W
Voltage type	AC
AC nominal voltage max	230 V
Frequenz max.	50 Hz
Lamp	LED
Protection class	II
Degree of protection	IP20
Control	DALI
Bulb change possible	The light source of this luminaire may only be replaced by the manufacturer or a service technician commissioned by him or a similarly qualified person.
Rated life time L80/B50 at 25 °C	50.000 h

Mounting technology	
Mounting method	Recessed mounting
Place of installation	Ceiling-mounted
Adjustability	Rotable and pivoted
Swivel angle	90°
Rotation angle	350°
Head adjustable angle	90°
Further references	No cover with thermal insulation material
Material cover	Glass transparent
Suitable for through-wiring	No

Packing data	
Gross weight	N.N.
Length of packaging	175 mm
Packaging width	175 mm
Packaging height	150 mm
Disposal at end of life	This product must not be disposed of with household waste. You are obliged, to dispose of such electrical waste separately. By disposing of electrical waste and other old or defective electronics separately, you support recycling or other forms of re-use. In that way you help to take care and to avoid that harmful substances get into the environment.