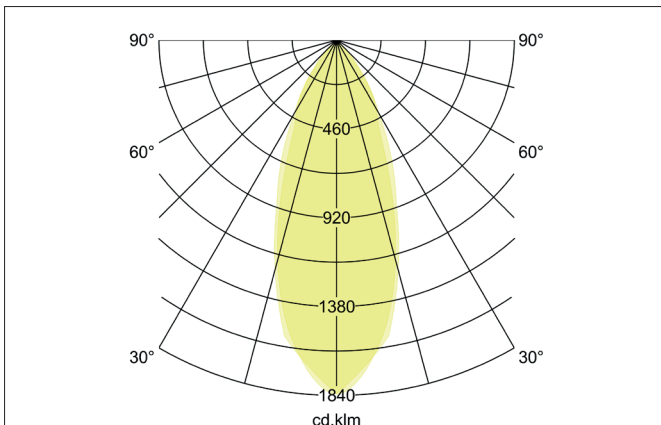
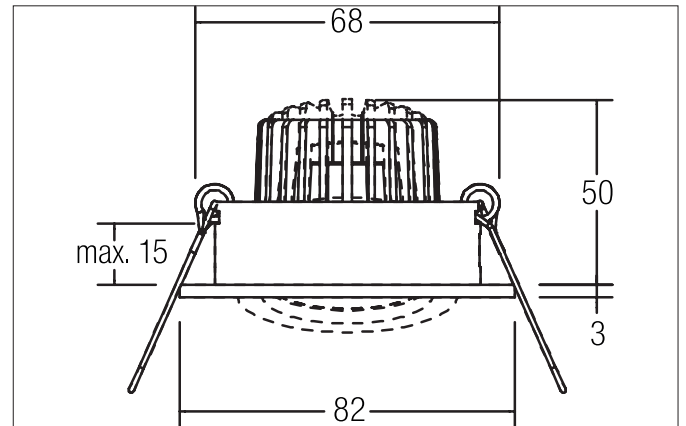
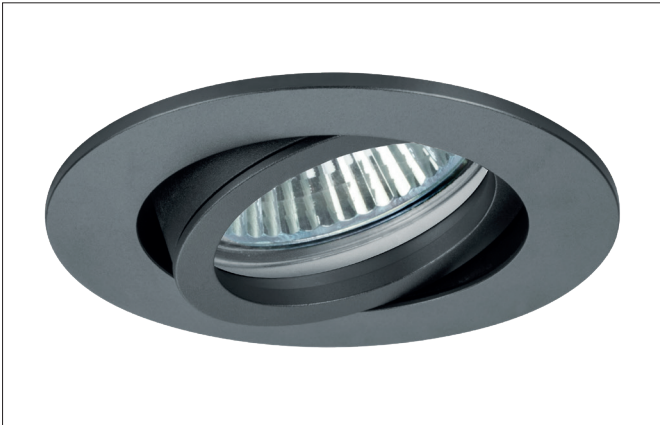

PAYTON-R LED recessed spot

Article no. 12373644

Light.
For Generations.**Tender**

LED recessed spot, Round. Toolless ceiling installation by installation springs. Ceiling cut-out \varnothing 68 mm, Installation depth 50 mm, Outer diameter 82 mm, Weight 0,140 kg, Reflector silver with rotationssymmetrical, deep, wide distributed light intensity. optimal light distribution due to a glass transparent cover. Luminous flux 340 lm, Power 1 x 3 W, Light colour neutral white, Correlated color temperature (CCT) 4.000 K, Colour rendering index CRI > 80, Housing material: Aluminium / Glass, Colour: Titanium, Permissible ambient temperature (ta): -20 °C - +25 °C, Protection class (EN 61140): III, Degree of protection (DIN EN 60529): IP20, .For connection to an external driver, which is not included in the scope of delivery of the luminaire. Depending on driver dimmable.

Product Benefits

- Round recessed spotlight made of solid aluminum with glass cover.
- Easy and tool-free mounting.
- CRI > 80.
- Low installation depth 50 mm, diameter 82 mm, Ceiling cut-out 68 mm.
- Ceiling thickness maximum 13 mm.
- Large article variance in terms of housing color and color temperature.
- Power supply with 350 mA.
- Alternatively available in square design.

PAYTON-R LED recessed spot

Article no. 12373644

Light.
For Generations.

| Article data | |
|--------------------|-------------------|
| Article no. | 12373644 |
| GTIN | 4251433946595 |
| Series name | PAYTON-R |
| Short description | LED recessed spot |
| Material | Aluminium / Glass |
| Colour | Titanium |
| Type of surface | Matt |
| Shape | Round |
| Outer diameter | 82 mm |
| Built-in diameter | 68 mm |
| Installation depth | 50 mm |
| Hight | 3 mm |
| Weight | 0.140 kg |
| stamp | UKCA |

| Lighting technology | |
|------------------------------|------------|
| Colour temperature | 4.000 K |
| Light colour | White |
| Light output | Direct |
| Luminous flux | 340 lm |
| System efficiency | 113 lm/W |
| Colour rendering | CRI > 80 |
| Reflector | High-gloss |
| Reflector colour | silver |
| Beam angle | 38° |
| Light sharing | Symmetric |
| Adjustable color temperature | No |

| Operating technology of the luminaire | |
|---------------------------------------|--|
| Voltage type | DC |
| Current | 350 mA |
| Lamp | LED |
| Lamp holder | Plug&Play |
| Protection class | III |
| Degree of protection | IP20 |
| Dimmable | Depending on type of control gear |
| Control | Depending on driver |
| Bulb change possible | The light source of this luminaire may only be replaced by the manufacturer or a service technician commissioned by him or a similarly qualified person. |

| Mounting technology | |
|-----------------------------|---|
| Mounting method | Recessed mounting |
| Place of installation | Ceiling-mounted |
| Adjustability | Pivoted |
| Swivel angle | 20° |
| Max. ceiling thickness | 13 mm |
| Further references | No cover with thermal insulation material |
| Material cover | Glass transparent |
| Circlip | Without circlip |
| Suitable for through-wiring | Yes, with optional accessories |

PAYTON-R LED recessed spot

Article no. 12373644

Light.
For Generations.

| Packing data | |
|-------------------------|--|
| Gross weight | 0.213 kg |
| Length of packaging | 100 mm |
| Packaging width | 100 mm |
| Packaging height | 100 mm |
| Disposal at end of life | <p>This product must not be disposed of with household waste. You are obliged, to dispose of such electrical waste separately.</p> <p>By disposing of electrical waste and other old or defective electronics separately, you support recycling or other forms of re-use. In that way you help to take care and to avoid that harmful substances get into the environment.</p> |

PAYTON-R LED recessed spot

Article no. 12373644

Light.
For Generations.

| Accessories | |
|---|---|
|  | Article no.: 17665000 LED converter 350 mA, switchable Power: 1 - 3,2 W Dimensions: 52 mm x 30 mm x 23 mm |
|  | Article no.: 17662000 LED converter 350 mA, on/off switchable Power: 1 - 7,2 W Dimensions: 68 mm x 35 mm x 21 mm |
|  | Article no.: 17662010 LED converter 350 mA, on/off switchable Power: 1 - 7,2 W Dimensions: 68 mm x 35 mm x 21 mm |
|  | Article no.: 17662020 LED converter 350 mA, on/off switchable Power: 1 - 7,2 W Dimensions: 68 mm x 35 mm x 21 mm |
|  | Article no.: 17613000 LED converter 350 mA, on/off switchable Power: 1 - 15 W Dimensions: 115 mm x 34 mm x 19 mm |
|  | Article no.: 17613010 LED converter 350 mA, on/off switchable Power: 1 - 15 W Dimensions: 115 mm x 34 mm x 19 mm |
|  | Article no.: 17613020 LED converter 350 mA, on/off switchable Power: 1 - 15 W Dimensions: 115 mm x 34 mm x 19 mm |
|  | Article no.: 17621000 LED converter 350 mA, on/off switchable Power: 1 - 21 W Dimensions: 128 mm x 50 mm x 13 mm |
|  | Article no.: 17621010 LED converter 350 mA, on/off switchable Power: 1 - 21 W Dimensions: 128 mm x 50 mm x 13 mm |
|  | Article no.: 17621020 LED converter 350 mA, on/off switchable Power: 1 - 21 W Dimensions: 128 mm x 50 mm x 13 mm |

PAYTON-R LED recessed spot

Article no. 12373644



Light.
For Generations.

| Accessories | |
|---|--|
|  | Article no.: 17663000 LED converter 350 mA, trailing-edge phase dimmable Power: 2,8 - 7 W Dimensions: 110 mm x 50 mm x 19 mm |
|  | Article no.: 17663010 LED converter 350 mA, trailing-edge phase dimmable Power: 2,8 - 7 W Dimensions: 110 mm x 50 mm x 19 mm |
|  | Article no.: 17663020 LED converter 350 mA, trailing-edge phase dimmable Power: 2,8 - 7 W Dimensions: 110 mm x 50 mm x 19 mm |
|  | Article no.: 17648000 LED converter 350 mA, trailing-edge phase dimmable Power: 0,7 - 17 W Dimensions: 166 mm x 46 mm x 34 mm |
|  | Article no.: 17648010 LED converter 350 mA, trailing-edge phase dimmable Power: 0,7 - 17 W Dimensions: 166 mm x 46 mm x 34 mm |
|  | Article no.: 17648020 LED converter 350 mA, trailing-edge phase dimmable Power: 0,7 - 17 W Dimensions: 166 mm x 46 mm x 34 mm |
|  | Article no.: 17684000 LED converter 350 mA, DALI dimmable (digital) Power: 2,8 - 7 W Dimensions: 130 mm x 42 mm x 22 mm |
|  | Article no.: 17684010 LED converter 350 mA, DALI dimmable (digital) Power: 2,8 - 7 W Dimensions: 130 mm x 42 mm x 22 mm |
|  | Article no.: 17684020 LED converter 350 mA, DALI dimmable (digital) Power: 2,8 - 7 W Dimensions: 130 mm x 42 mm x 22 mm |
|  | Article no.: 17658000 LED round converter 350 mA, DALI dimmable (digital) Power: 2,1 - 9 W Dimensions: 56 mm x 25 mm |
|  | Article no.: 17658010 LED round converter 350 mA, DALI dimmable (digital) Power: 2,1 - 9 W Dimensions: 56 mm x 25 mm |

PAYTON-R LED recessed spot

Article no. 12373644

Light.
For Generations.

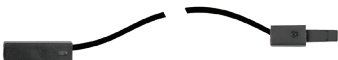
| Accessories | |
|---|---|
|  | <p>Article no.: 17658020 LED round converter 350 mA, DALI dimmable (digital) Power: 2,1 - 9 W Dimensions: 56 mm x 25 mm</p> |
|  | <p>Article no.: 3835 Plug & Play extension lead 350 mA Dimensions: 500 mm</p> |
|  | <p>Article no.: 3836 Plug & Play extension lead 350 mA Dimensions: 1,000 mm</p> |
|  | <p>Article no.: 3837 Plug & Play extension lead 350 mA Dimensions: 2,000 mm</p> |