

MARICE-S LED recessed spot, IP65, dim2warm
 Article no. 12446253

Light.
 For Generations.

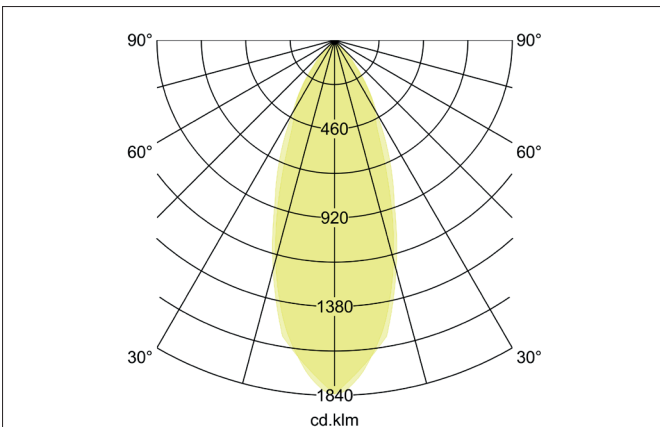
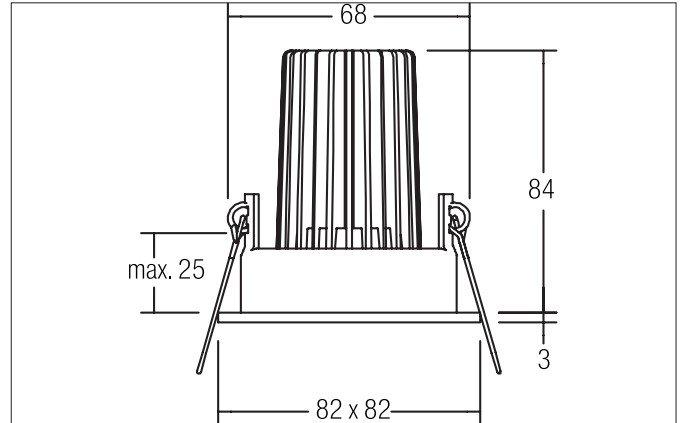

Tender
 LED recessed spot, IP65, dim2warm, Square. Toolless ceiling installation by installation springs. Ceiling cut-out Ø 68 mm, Installation depth 84 mm, Length 82 mm, Width 82 mm, Weight 0,240 kg, Reflector silver with rotationssymmetrical, deep, wide distributed light intensity. optimal light distribution due to a plastic, transparent cover. Luminous flux 900 lm, Power 1 x 12 W, Light colour warm white to Structure-Nodelmpl 4028e4bd62d2f56b0163735096916a6c, Correlated color temprature (CCT) 3.000 - 1.800 K, Colour rendering index CRI > 90, Housing material: Aluminium / Steel / Silicone rubber / Plastic, Colour: Alu, Permissible ambient temperature (ta): -20 °C - +25 °C, Protection class (EN 61140): III, Degree of protection (DIN EN 60529): IP65 when installing in closed ceilings, .For connection to an external driver, which is not included in the scope of delivery of the luminaire. Depending on driver dimmable.

MARICE-S LED recessed spot, IP65, dim2warm

Article no. 12446253

Light.
For Generations.

| Article data | |
|--------------------|---|
| Article no. | 12446253 |
| GTIN | 4251433914303 |
| Series name | MARICE-S |
| Short description | LED recessed spot, IP65, dim2warm |
| Material | Aluminium / Steel / Silicone rubber / Plastic |
| Colour | Alu |
| Type of surface | Matt |
| Shape | Square |
| Built-in diameter | 68 mm |
| Installation depth | 84 mm |
| Length | 82 mm |
| Width | 82 mm |
| Hight | 3 mm |
| Weight | 0.240 kg |
| stamp | UKCA |
| Conformance | CE, UKCA |

| Lighting technology | |
|------------------------------|-------------------|
| Colour temperature | 3.000 K - 1.800 K |
| Light output | Direct |
| Luminous flux | 900 lm |
| System efficiency | 75 lm/W |
| Colour rendering | CRI > 90 |
| Reflector | High-gloss |
| Reflector colour | silver |
| Beam angle | 38° |
| Light sharing | Symmetric |
| Adjustable color temperature | Infinite control |

| Operating technology of the luminaire | |
|---------------------------------------|--|
| System output | 12 W |
| Voltage type | DC |
| Current | 350 mA |
| Lamp | LED |
| Lamp holder | Plug&Play |
| Protection class | III |
| Degree of protection | IP65 |
| Protection class on the ceiling side | IP20 |
| Dimmable | Depending on type of control gear |
| Control | Depending on driver |
| Bulb change possible | The light source of this luminaire may only be replaced by the manufacturer or a service technician commissioned by him or a similarly qualified person. |

| Mounting technology | |
|------------------------|---|
| Mounting method | Recessed mounting |
| Place of installation | Ceiling-mounted |
| Adjustability | Pivoted |
| Swivel angle | 30° |
| Max. ceiling thickness | 25 mm |
| Further references | No cover with thermal insulation material |
| Material cover | Plastic, transparent |

MARICE-S LED recessed spot, IP65, dim2warm

Article no. 12446253

Light.
For Generations.

| Packing data | |
|-------------------------|--|
| Gross weight | 0.281 kg |
| Length of packaging | 95 mm |
| Packaging width | 95 mm |
| Packaging height | 95 mm |
| Disposal at end of life | <p>This product must not be disposed of with household waste. You are obliged, to dispose of such electrical waste separately.</p> <p>By disposing of electrical waste and other old or defective electronics separately, you support recycling or other forms of re-use. In that way you help to take care and to avoid that harmful substances get into the environment.</p> |

MARICE-S LED recessed spot, IP65, dim2warm

Article no. 12446253











Light.
For Generations.

| Accessories | |
|---|---|
|  | Article no.: 17664000 LED converter 350 mA, trailing-edge phase dimmable Power: 10,2 - 14 W Dimensions: 125 mm x 51 mm x 20 mm |
|  | Article no.: 17664010 LED converter 350 mA, trailing-edge phase dimmable Power: 10,2 - 14 W Dimensions: 125 mm x 51 mm x 20 mm |
|  | Article no.: 17664020 LED converter 350 mA, trailing-edge phase dimmable Power: 10,2 - 14 W Dimensions: 125 mm x 51 mm x 20 mm |
|  | Article no.: 17643000 LED converter 350 mA, trailing-edge phase dimmable Power: 8,8 - 18 W Dimensions: 110 mm x 52 mm x 22 mm |
|  | Article no.: 17643010 LED converter 350 mA, trailing-edge phase dimmable Power: 8,8 - 18 W Dimensions: 110 mm x 52 mm x 22 mm |
|  | Article no.: 17643020 LED converter 350 mA, trailing-edge phase dimmable Power: 8,8 - 18 W Dimensions: 110 mm x 52 mm x 22 mm |
|  | Article no.: 17657000 LED converter 350 mA, 1-10 V dimmable (analog) Power: 5,2 - 18 W Dimensions: 110 mm x 52 mm x 22 mm |
|  | Article no.: 17657010 LED converter 350 mA, 1-10 V dimmable (analog) Power: 5,2 - 18 W Dimensions: 110 mm x 52 mm x 22 mm |
|  | Article no.: 17683000 LED converter 350 mA, DALI dimmable (digital) Power: 3,5 - 17 W Dimensions: 110 mm x 52 mm x 22 mm |
|  | Article no.: 17683010 LED converter 350 mA, DALI dimmable (digital) Power: 3,5 - 17 W Dimensions: 110 mm x 52 mm x 22 mm |

MARICE-S LED recessed spot, IP65, dim2warm

Article no. 12446253

Light.
For Generations.

| Accessories | |
|---|---|
|  | <p>Article no.: 17683020 LED converter 350 mA, DALI dimmable (digital) Power: 3,5 - 17 W Dimensions: 110 mm x 52 mm x 22 mm</p> |
|  | <p>Article no.: 17671000 LED converter 350mA, ZigBee dimmable Power: 3,5 - 18,5 W Dimensions: 146 mm x 44 mm x 30 mm</p> |
|  | <p>Article no.: 17671010 LED converter 350mA, ZigBee dimmable Power: 3,5 - 18,5 W Dimensions: 146 mm x 44 mm x 30 mm</p> |
|  | <p>Article no.: 17671020 LED converter 350mA, ZigBee dimmable Power: 3,5 - 18,5 W Dimensions: 146 mm x 44 mm x 30 mm</p> |
|  | <p>Article no.: 17672000 LED converter 350mA, Casambi dimmable Power: 3,5 - 18 W Dimensions: 146 mm x 44 mm x 30 mm</p> |
|  | <p>Article no.: 17672010 LED converter 350mA, Casambi dimmable Power: 3,5 - 18 W Dimensions: 146 mm x 44 mm x 30 mm</p> |
|  | <p>Article no.: 17672020 LED converter 350mA, Casambi dimmable Power: 3,5 - 18 W Dimensions: 146 mm x 44 mm x 30 mm</p> |
|  | <p>Article no.: 3835 Plug & Play extension lead 350 mA Dimensions: 500 mm</p> |
|  | <p>Article no.: 3836 Plug & Play extension lead 350 mA Dimensions: 1,000 mm</p> |
|  | <p>Article no.: 3837 Plug & Play extension lead 350 mA Dimensions: 2,000 mm</p> |