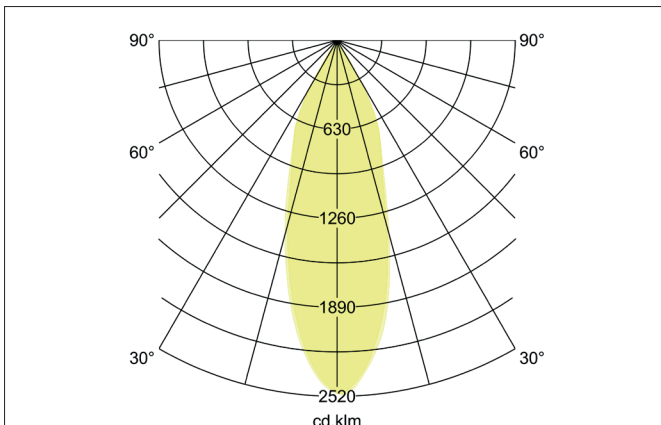
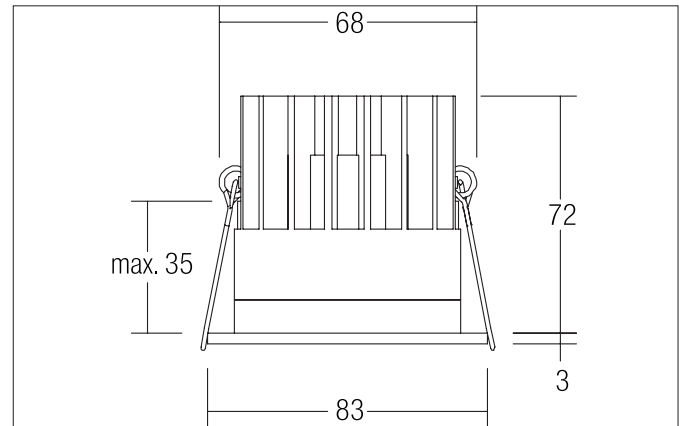

**ALTERO-R LED recessed downlight, IP44**

Article no. 12035403

**Tender**

Round LED recessed downlight, IP44, tool-free ceiling installation using installation springs. Ceiling cut-out Ø 68 mm, installation depth 72 mm, outer diameter 83 mm, weight 0.241 kg, silver reflector with rotationally symmetrical deep-wide beam light distribution. Cover glass transparent, rated luminous flux 820 lm, rated power 1 x 9.2 W, light color warm white, most similar color temperature (CCT) 3,000 K, general color rendering index CRI > 80, housing material: aluminum, color: textured white / chrome, permissible ambient temperature (ta): -20 °C - +25 °C, protection class (EN 61140): III, degree of protection (DIN EN 60529): IP44 when installed in closed ceilings. For connection to an external control gear, which is not included with the luminaire. Dimmable depending on the control gear.

**Product Benefits**

- Modular aufgebaute Produktserie mit hoher Farbvarianz.
- Für flexible Beleuchtungslösungen bei veränderlichen Raumkonzepten von neutral bis akzentuiert.
- Lieferbar in den Farbtemperaturen 3.000 K und 4.000 K und dim2warm (3.000 K - 1.800 K), TunableWhite (2.700 K - 6.500 K) und 2.700 K.
- Standard-Deckenausschnitt 68 mm.
- Vertiefter Lichtaustritt.
- Schutzart IP44 bei Einbau in geschlossenen Decken.
- Ebenfalls lieferbar in quadratischer Ausführung.

**ALTERO-R LED recessed downlight, IP44**

Article no. 12035403

Article data	
Article no.	12035403
GTIN	4251433915911
Series name	ALTERO-R
Short description	LED recessed downlight, IP44
Material	Aluminium
Colour	White / Chrome
Type of surface	Structure
Shape	Round
Outer diameter	83 mm
Built-in diameter	68 mm
Installation depth	72 mm
Hight	3 mm
Weight	0.241 kg
Conformance	CE, UKCA

Lighting technology	
Colour temperature	3.000 K
Light colour	White
Light output	Direct
Luminous flux	820 lm
System efficiency	89 lm/W
Colour rendering	CRI > 80
Reflector	Faceted
Reflector colour	silver
Beam angle	33°
Light sharing	Symmetric
Adjustable color temperature	No

Operating technology of the luminaire	
System output	9.2 W
Voltage type	DC
Current	500 mA
Lamp	LED
Protection class	III
Degree of protection	IP44
Protection class on the ceiling side	IP20
Dimmable	Depending on type of control gear
Control	Depending on driver
Bulb change possible	The light source of this luminaire may only be replaced by the manufacturer or a service technician commissioned by him or a similarly qualified person.

Mounting technology	
Mounting method	Recessed mounting
Place of installation	Ceiling-mounted
Adjustability	Not adjustable
Max. ceiling thickness	35 mm
Further references	No cover with thermal insulation material
Material cover	Glass transparent

**ALTERO-R LED recessed downlight, IP44**

Article no. 12035403

Packing data	
Gross weight	0.291 kg
Length of packaging	100 mm
Packaging width	100 mm
Packaging height	100 mm
Disposal at end of life	<p>This product must not be disposed of with household waste. You are obliged, to dispose of such electrical waste separately.</p> <p>By disposing of electrical waste and other old or defective electronics separately, you support recycling or other forms of re-use. In that way you help to take care and to avoid that harmful substances get into the environment.</p>

Required accessories	
Article no.: 17823010	LED converter 500 mA, on/off switchable
Power: 1 - 22 W, ohne Konfektionierung	
Dimensions: 146 mm x 43.5 mm x 30 mm	
<a href="https://www.brumberg.com/fileadmin/products/Datenblatt_17823010_2021_DE.pdf">https://www.brumberg.com/fileadmin/products/Datenblatt_17823010_2021_DE.pdf</a>	
Article no.: 17822010	LED converter 500 mA, trailing-edge phase dimmable
Power: 8 - 20 W, ohne Konfektionierung	
Dimensions: 110 mm x 52 mm x 22 mm	
<a href="https://www.brumberg.com/fileadmin/products/Datenblatt_17822010_2021_DE.pdf">https://www.brumberg.com/fileadmin/products/Datenblatt_17822010_2021_DE.pdf</a>	
Article no.: 17829010	LED converter 500 mA, trailing-edge phase dimmable
Power: 1 - 24 W, ohne Konfektionierung	
Dimensions: 166 mm x 46 mm x 34 mm	
<a href="https://www.brumberg.com/fileadmin/products/Datenblatt_17829010_2021_DE.pdf">https://www.brumberg.com/fileadmin/products/Datenblatt_17829010_2021_DE.pdf</a>	
Article no.: 17824010	LED converter 500 mA, 1-10V dimmable (analog)
Power: 5 - 27 W, ohne Konfektionierung	
Dimensions: 146 mm x 43.5 mm x 30 mm	
<a href="https://www.brumberg.com/fileadmin/products/Datenblatt_17824010_2021_DE.pdf">https://www.brumberg.com/fileadmin/products/Datenblatt_17824010_2021_DE.pdf</a>	
Article no.: 17826010	LED converter 500 mA, DALI dimmable (digital)
Power: 5 - 27 W, ohne Konfektionierung	
Dimensions: 146 mm x 44 mm x 30 mm	
<a href="https://www.brumberg.com/fileadmin/products/Datenblatt_17826010_2021_DE.pdf">https://www.brumberg.com/fileadmin/products/Datenblatt_17826010_2021_DE.pdf</a>	

Optional accessories	
Article no.: 83330000	Connection box 230 V AC, 3-pole
Dimensions: 80 mm x 41 mm x 34 mm	
<a href="https://www.brumberg.com/fileadmin/products/Datenblatt_83330000_2021_DE.pdf">https://www.brumberg.com/fileadmin/products/Datenblatt_83330000_2021_DE.pdf</a>	
Article no.: 83331000	Connection box 230 V AC, 5-pole (DALI / 1-10 V)
Dimensions: 95 mm x 55 mm x 30 mm	
<a href="https://www.brumberg.com/fileadmin/products/Datenblatt_83331000_2021_DE.pdf">https://www.brumberg.com/fileadmin/products/Datenblatt_83331000_2021_DE.pdf</a>	