

ARTEMIS MAXI LED recessed spotlight, DALI
Article no. 88271174DA

Light.
For Generations.

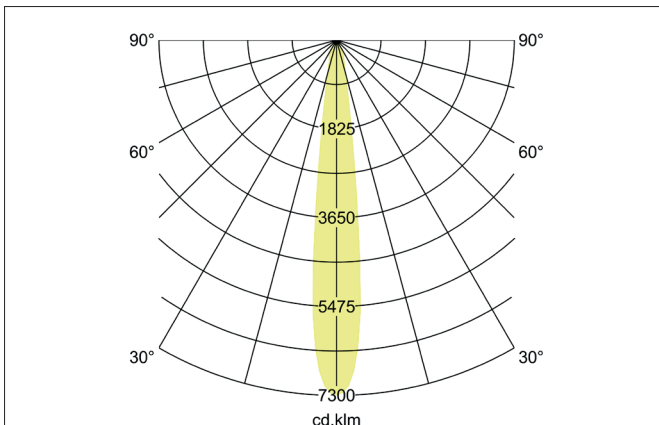
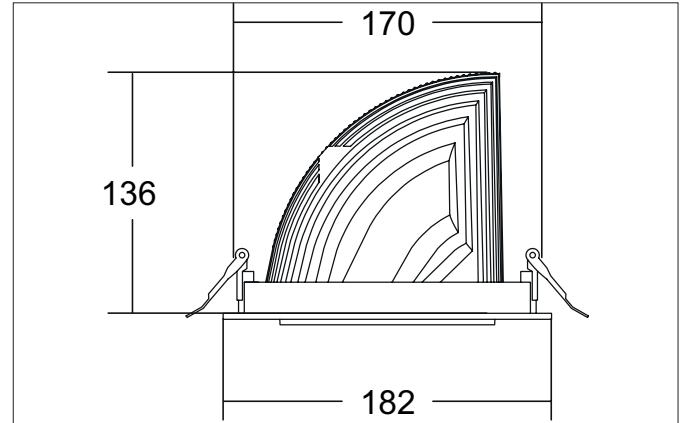

Tender

LED recessed spotlight, DALI, Round. Ceiling cut-out Ø 170 mm, Installation depth 136 mm, Outer diameter 182 mm, with rotationssymmetrical, deep, wide distributed light intensity. optimal light distribution due to a glass transparent cover. Luminous flux 5.139 lm, Power 1 x 41,5 W, Light colour neutral white, Correlated color temperature (CCT) 4.000 K, Colour rendering index CRI > 90, Housing material: Aluminium, Colour: White structure, Permissible ambient temperature (ta): -20 °C - +25 °C, Protection class (EN 61140): II, Degree of protection (DIN EN 60529): IP20, .With electronic driver, DALI dimmable.

Article data	
Article no.	88271174DA
GTIN	4251433986355
Series name	ARTEMIS MAXI
Short description	LED recessed spotlight, DALI
Material	Aluminium
Colour	White
Type of surface	Structure
Shape	Round
Outer diameter	182 mm
Built-in diameter	170 mm
Installation depth	136 mm
Weight	N.N.

ARTEMIS MAXI LED recessed spotlight, DALI

Article no. 88271174DA

Light.
For Generations.

Lighting technology	
Colour temperature	4.000 K
Light colour	White
Light output	Direct
Luminous flux	5,139 lm
System efficiency	124 lm/W
Colour rendering	CRI > 90
Reflector	High-gloss
Beam angle	12°
Light sharing	Symmetric

Operating technology of the luminaire	
Voltage type	AC
AC nominal voltage max	230 V
Frequenz max.	50 Hz
Lamp	LED
Protection class	II
Degree of protection	IP20
Control	DALI
Bulb change possible	The light source of this luminaire may only be replaced by the manufacturer or a service technician commissioned by him or a similarly qualified person.

Mounting technology	
Mounting method	Recessed mounting
Place of installation	Ceiling-mounted
Adjustability	Rotatable and adjustable head
Swivel angle	90°
Rotation angle	350°
Head adjustable angle	90°
Further references	No cover with thermal insulation material
Material cover	Glass transparent
Suitable for through-wiring	No

Packing data	
Gross weight	N.N.
Length of packaging	N.N.
Packaging width	N.N.
Packaging height	N.N.
Disposal at end of life	This product must not be disposed of with household waste. You are obliged, to dispose of such electrical waste separately. By disposing of electrical waste and other old or defective electronics separately, you support recycling or other forms of re-use. In that way you help to take care and to avoid that harmful substances get into the environment.