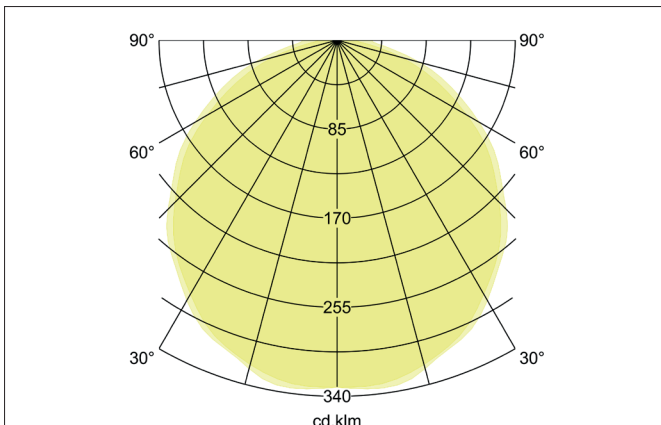
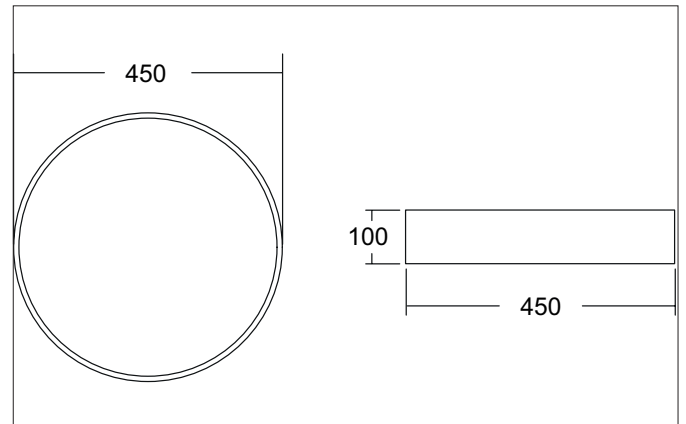

BIRO CIRCLE LED surface luminaire, DALI dimmable

Article no. 13695164

Tender

LED surface luminaire, DALI dimmable, Round. Luminaire diameter 450.0 mm, Hight 100.0 mm Weight 3.0 kg, with rotationssymmetrical, deep, wide distributed light intensity. Cover plastic, opal. Luminous flux 2.550 lm, Power 1 x 25 W, Light colour neutral white, Correlated color temperature (CCT) 4.000 K, Colour rendering index CRI > 80, Rated life time L70/B50 at 25 °C: 50.000 h, Rated life time L80/B50 at 25 °C: 50.000 h, Housing material: Aluminium / Steel / Plastic, Colour: Silver structure, Permissible ambient temperature (ta): -20 °C - +25 °C, Protection class (EN 61140): I, Degree of protection (DIN EN 60529): IP40. With electronic driver, DALI-DT6 dimmable.

Article data	
Article no.	13695164
GTIN	4251433940630
Series name	BIRO CIRCLE
Short description	LED surface luminaire, DALI dimmable
Material	Aluminium / Steel / Plastic
Colour	Silver
Type of surface	Structure
Shape	Round
Outer diameter	450 mm
Hight	100 mm
Scope of delivery	Incl. converter for connection to the 230-V mains voltage
Weight	3.000 kg
Conformance	CE, UKCA

BIRO CIRCLE LED surface luminaire, DALI dimmable

Article no. 13695164

Lighting technology	
Colour temperature	4.000 K
Light colour	White
Light output	Direct
Luminous flux	2,550 lm
System efficiency	102 lm/W
McAdam-Step	McAdam-Step 3
Colour rendering	CRI > 80
Reflector	Without
Beam angle	110°
Light sharing	Symmetric
Adjustable color temperature	No

Operating technology of the luminaire	
System output	25 W
Voltage type	AC
AC nominal voltage max	230 V
Frequency max	50 Hz
Lamp	LED
Lamp holder	Without fitting
Protection class	I
Degree of protection	IP40
Control	DALI-DT6
Bulb change possible	The light source of this luminaire may only be replaced by the manufacturer or a service technician commissioned by him or a similarly qualified person.
Rated life time L70/B50 at 25 °C	50,000 h
Rated life time L80/B50 at 25 °C	50.000 h

Mounting technology	
Mounting method	Surface mounting
Place of installation	Ceiling-mounted
Adjustability	Not adjustable
Material cover	Plastic, opal

Packing data	
Gross weight	3.5 kg
Length of packaging	480 mm
Packaging width	480 mm
Packaging height	110 mm
Disposal at end of life	This product must not be disposed of with household waste. You are obliged, to dispose of such electrical waste separately. By disposing of electrical waste and other old or defective electronics separately, you support recycling or other forms of re-use. In that way you help to take care and to avoid that harmful substances get into the environment.