

BIRO40 LED recessed profile

Article no. 77034078

Light.
For Generations.

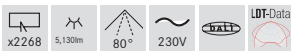
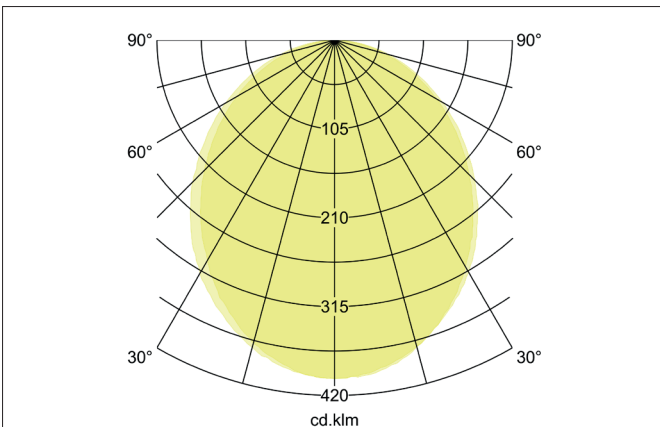
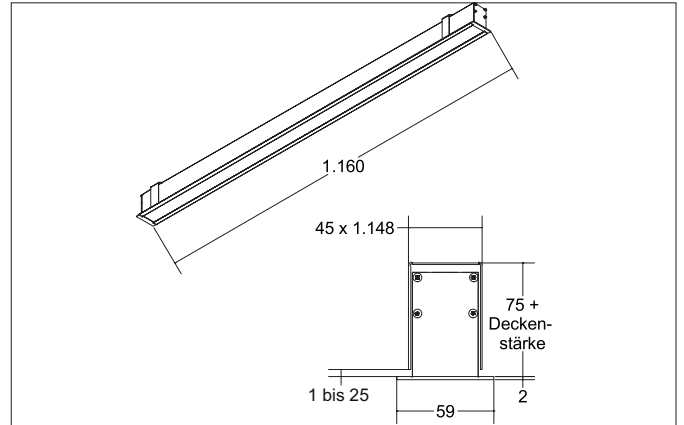

Tender

LED recessed profile, Rectangular. Ceiling installation by cross-lot screwdriver using Ph2. Ceiling cut-out L x W 2268 x 45 mm, Installation depth 110 mm, Length 2.278 mm, Width 59 mm, Weight 3,790 kg, with rotationssymmetrical, deep, wide distributed light intensity. optimal light distribution due to a plastic, satinised cover. Luminous flux 5.130 lm, UGR < 25, Power 62,7 W, System Efficiency 82 lm/W, Light colour warm white to daylight white, Correlated color temperature (CCT) 2.700 - 6.500 K, Colour rendering index CRI > 80, Rated life time L70/B50 at 25 °C: 65000 h, Rated life time L80/B50 at 25 °C: 70000 h, Housing material: Aluminium / Acrylic, Colour: White, Permissible ambient temperature (ta): -20 °C - +25 °C, Protection class (EN 61140): I, Degree of protection (DIN EN 60529): IP20. With electronic driver, DALI dimmable.

Article data	
Article no.	77034078
GTIN	4251433934233
Series name	BIRO40
Short description	LED recessed profile
Material	Aluminium / Acrylic
Colour	White
Shape	Rectangular
Built-in width	45 mm
Built-in length	2268 mm
Installation depth	110 mm
Length	2,278 mm
Width	59 mm
Weight	3.790 kg

BIRO40 LED recessed profile

Article no. 77034078

Light.
For Generations.

Lighting technology	
Colour temperature	2.700 K - 6.500 K
Light colour	White
Light output	Direct
Luminous flux	5,130 lm
System efficiency	82 lm/W
McAdam-Step	McAdam-Step 3
Colour rendering	CRI > 80
Luminaire optics	Cover satin
Reflector	Without
Beam angle	80°
Glare evaluation	UGR < 25
Light sharing	Symmetric

Operating technology of the luminaire	
System output	62.7 W
Voltage type	AC
AC nominal voltage max	230 V
Frequenz max.	50 Hz
Lamp	LED
Protection class	I
Degree of protection	IP20
Control	DALI
Rated life time L70/B50 at 25 °C	65,000 h
Rated life time L80/B50 at 25 °C	70.000 h

Mounting technology	
Mounting method	Recessed mounting
Place of installation	Ceiling-mounted
Adjustability	Not adjustable
Max. ceiling thickness	25 mm
Further references	No cover with thermal insulation material
Material cover	Plastic, satinised

Packing data	
Gross weight	4.58 kg
Length of packaging	2,300 mm
Packaging width	160 mm
Packaging height	135 mm
Disposal at end of life	This product must not be disposed of with household waste. You are obliged, to dispose of such electrical waste separately. By disposing of electrical waste and other old or defective electronics separately, you support recycling or other forms of re-use. In that way you help to take care and to avoid that harmful substances get into the environment.