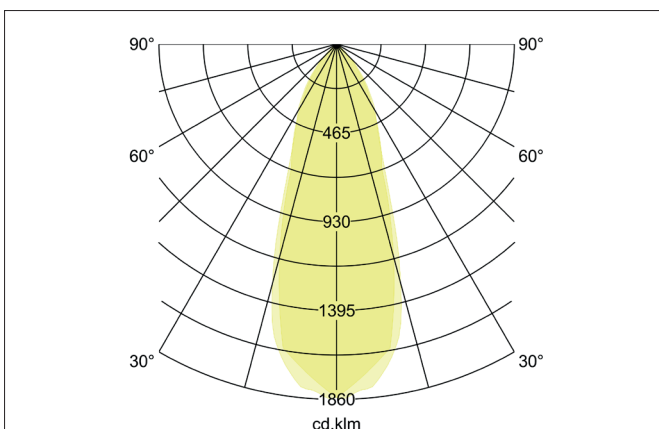
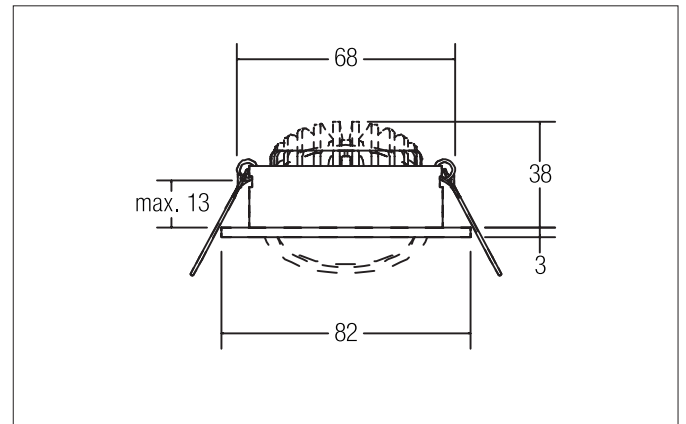

SEVEN-R LED recessed spot set, trailing-edge phase dimmable

Article no. 39361643

Light.
For Generations.**Tender**

LED recessed spot set, trailing-edge phase dimmable, Round. Toolless ceiling installation by installation springs. Ceiling cut-out Ø 68 mm, Installation depth 38 mm, Outer diameter 82 mm, Weight 0,179 kg. Reflector silver with rotationssymmetrical, deep, wide distributed light intensity. optimal light distribution due to a plastic, transparent cover. Luminous flux 740 lm, Power 1 x 7 W, System Efficiency 106 lm/W, Light colour warm white, Correlated color temperature (CCT) 3.000 K, Colour rendering index CRI > 80, Rated life time L70/B50 at 25 °C: 50.000 h, Housing material: Aluminium / Polycarbonate, Colour: Titanium, Permissible ambient temperature (ta): -20 °C - +25 °C, Protection class (EN 61140): II, Degree of protection (DIN EN 60529): IP20, .With electronic driver, Trailing-edge phase dimmable with integrated strain relief.

Product Benefits

- Round recessed spotlight made of solid aluminum with polycarbonate cover.
- Easy and tool-free mounting.
- CRI > 80.
- Low mounting depth 38 mm, diameter 82 mm, Ceiling cut-out 68 mm.
- Ceiling thickness maximum 13 mm.
- Large article variance in terms of housing color and color temperature.
- Dimmable set (trailing-edge phase dimmer) - alternatively available in version for 350 mA and switchable set available.
- Alternatively available in square design.

SEVEN-R LED recessed spot set, trailing-edge phase dimmable

Article no. 39361643

Light.
For Generations.

Article data	
Article no.	39361643
GTIN	4251433919001
Series name	SEVEN-R
Short description	LED recessed spot set, trailing-edge phase dimmable
Material	Aluminium / Polycarbonate
Colour	Titanium
Type of surface	Matt
Shape	Round
Outer diameter	82 mm
Built-in diameter	68 mm
Installation depth	38 mm
Hight	3 mm
Weight	0.179 kg
stamp	MM, UKCA

Lighting technology	
Colour temperature	3.000 K
Light colour	White
Light output	Direct
Luminous flux	740 lm
System efficiency	106 lm/W
Colour rendering	CRI > 80
Reflector	High-gloss
Reflector colour	silver
Beam angle	38°
Light sharing	Symmetric
Adjustable color temperature	No

Operating technology of the luminaire	
Hight	3 mm
Lamp holder	Plug&Play
Power	7 W
Voltage type	DC
Current	350 mA
Lamp	LED
Protection class	III
Degree of protection	IP20
Rated life time L70/B50 at 25 °C	50,000 h
Bulb change possible	The light source of this luminaire may only be replaced by the manufacturer or a service technician commissioned by him or a similarly qualified person.

SEVEN-R LED recessed spot set, trailing-edge phase dimmable

Article no. 39361643

Light.
For Generations.

Operating technology of driver	
Article No. of used driver	17663000
Length	110 mm
Width	50 mm
Hight	19 mm
AC nominal voltage min	198 V
AC nominal voltage max	264 V
Frequency max	60 Hz
Dimmable	Yes
Control	Trailing-edge phase
Starting current	1A (15,2 µs)
Power min	2.8 W
Power	7 W
Output current	350 mA
Degree of protection	IP20
Protection class	II
Flicker-free	Yes

Mounting technology	
Mounting method	Recessed mounting
Place of installation	Ceiling-mounted
Adjustability	Pivoted
Swivel angle	30°
Max. ceiling thickness	13 mm
Further references	No cover with thermal insulation material
Material cover	Plastic, transparent
Suitable for through-wiring	Yes, with optional accessories

Packing data	
Gross weight	0.209 kg
Length of packaging	95 mm
Packaging width	75 mm
Packaging hight	95 mm
Disposal at end of life	This product must not be disposed of with household waste. You are obliged, to dispose of such electrical waste separately. By disposing of electrical waste and other old or defective electronics separately, you support recycling or other forms of re-use. In that way you help to take care and to avoid that harmful substances get into the environment.