

**SOL MIDI LED low beam spot, DALI dimmable**  
Article no. 78312084

Light.  
For Generations.

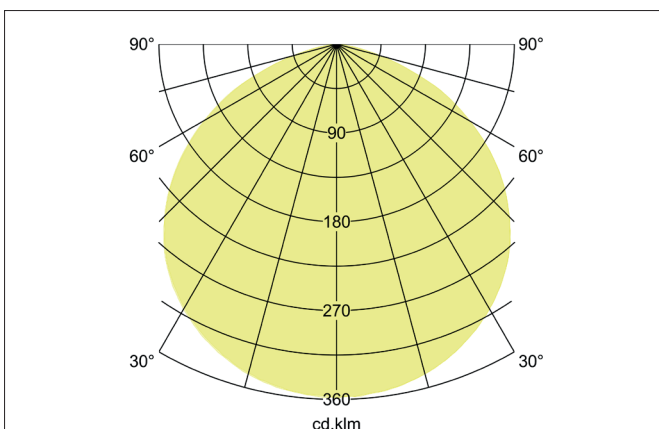
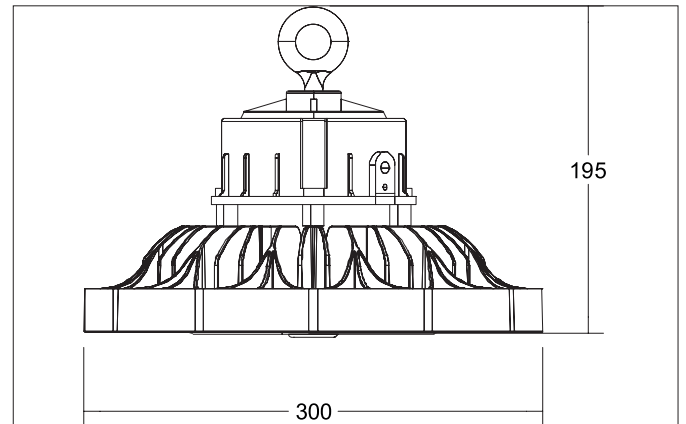

**Tender**

LED low beam spot, DALI dimmable, Round. Luminaire diameter 300.0 mm, Height 195.0 mm Weight 3.5 kg, with rotationssymmetrical, deep, wide distributed light intensity. optimal light distribution due to a plastic, transparent cover. Luminous flux 24.800 lm, Power 1 x 160 W, Light colour neutral white, Correlated color temperature (CCT) 4.000 K, Colour rendering index CRI > 80, Rated life time L70/B50 at 25 °C: 50.000 h, Rated life time L80/B50 at 25 °C: 50.000 h, Housing material: Aluminium / Polycarbonate, Colour: Black, Permissible ambient temperature (ta): -25 to +45°C, Protection class (EN 61140): I, Degree of protection (DIN EN 60529): IP65, shock resistance according to IEC62262: IK09 .With electronic driver, DALI-2 dimmable.

**Product Benefits**

- 5 years Brumberg light guarantee.
- Long life time: L80B50 >50,000 h at 25°C.
- High luminous efficiency: 160 lm per watt.
- As standard DALI-2 dimmable.
- Extensive accessories.
- Protection class: IP65.
- Low-maintenance lighting realization.
- Ambient temperature range: -25 °C to +45 °C.

**SOL MIDI LED low beam spot, DALI dimmable**

Article no. 78312084

Light.  
For Generations.

Article data	
Article no.	78312084
GTIN	4251433949398
Series name	SOL MIDI
Short description	LED low beam spot, DALI dimmable
Material	Aluminium / Polycarbonate
Colour	Black
Shape	Round
Outer diameter	300 mm
Hight	195 mm
Scope of delivery	Delivery: incl. screwable mounting eyelet, shrink end caps on the DALI cable and connection cable 1,500 mm
Weight	3.500 kg
Length of the connection line	1,500 mm
stamp	UKCA
Conformance	UKCA

Lighting technology	
Colour temperature	4.000 K
Light colour	White
Light output	Direct
Luminous flux	24,800 lm
System efficiency	155 lm/W
McAdam-Step	McAdam-Step 4
Colour rendering	CRI > 80
Luminaire optics	Lens
Beam angle	120°
Light sharing	Symmetric
Adjustable color temperature	No

Operating technology of the luminaire	
Voltage type	AC
AC nominal voltage max	230 V
Frequency max	50 Hz
Lamp	LED
Lamp holder	Without fitting
Protection class	I
Degree of protection	IP65
Ambient temperature	-25 up to +45°C
Dimmable	Yes
Control	DALI-2
Minimum / maximum dimming range	10 - 100 %
Length of the connection line	1,500 mm
Design of the connecting cable	Unilateral
Bulb change possible	The light source of this luminaire may only be replaced by the manufacturer or a service technician commissioned by him or a similarly qualified person.
Rated life time L70/B50 at 25 °C	50,000 h
Rated life time L80/B50 at 25 °C	50.000 h

**SOL MIDI LED low beam spot, DALI dimmable**

Article no. 78312084

Light.  
For Generations.

Operating technology of driver	
AC nominal voltage max	230 V
Frequency max	50 Hz
Protection class	I
Degree of protection	IP65
max. no. lights on C16 A	14
max. no. lights on B16 A	11
Starting current	1,5 A / 2 s
Power	160 W
Suitable for emergency lighting	No
Control	DALI-2
Flicker-free	Yes
Rated life time L70/B50 at 25 °C	50,000 h
Length of the connection line	1,500 mm
Design of the connecting cable	Unilateral









Mounting technology	
Mounting method	Suspended
Place of installation	Ceiling-mounted
Impact resistance	IK09
Material cover	Plastic, transparent
Suitable for through-wiring	Yes, with optional accessories

Packing data	
Gross weight	4.1 kg
Length of packaging	305 mm
Packaging width	180 mm
Packaging height	345 mm
Disposal at end of life	This product must not be disposed of with household waste. You are obliged, to dispose of such electrical waste separately. By disposing of electrical waste and other old or defective electronics separately, you support recycling or other forms of re-use. In that way you help to take care and to avoid that harmful substances get into the environment.

**SOL MIDI LED low beam spot, DALI dimmable**



Article no. 78312084

Light.  
For Generations.

Accessories	
	Article no.: 81062000 Change optics 60° to 78312
	Article no.: 81092000 Change optics 90° to 78312
	Article no.: 81046250 Aluminium luminaire shade to 78312  Dimensions: 370 mm x 140 mm
	Article no.: 81048000 PC light shade for 78312  Dimensions: 410 mm x 185 mm
	Article no.: 81049080 Ceiling / wall bracket for 78310 / 78311 / 78312
	Article no.: 81051000 Chain suspension, 1000 mm
	Article no.: 81052000 Chain suspension, 2,000 mm
	Article no.: 81053000 Chain suspension, 3000 mm
	Article no.: 81055000 Chain suspension, 5000 mm
	Article no.: 81057000 Cable connector, 3-pin, IP68, black  Dimensions: 125 mm

**SOL MIDI LED low beam spot, DALI dimmable**  
 Article no. 78312084

Light.  
 For Generations.

Accessories	
	<p>Article no.: 8 1058000                      Y-cable connector, 5-pole, IP68, black</p>
	<p>Article no.: 8 1050000                      Reducer, NPT 3/4" on M10                      Dimensions: 70 mm</p>