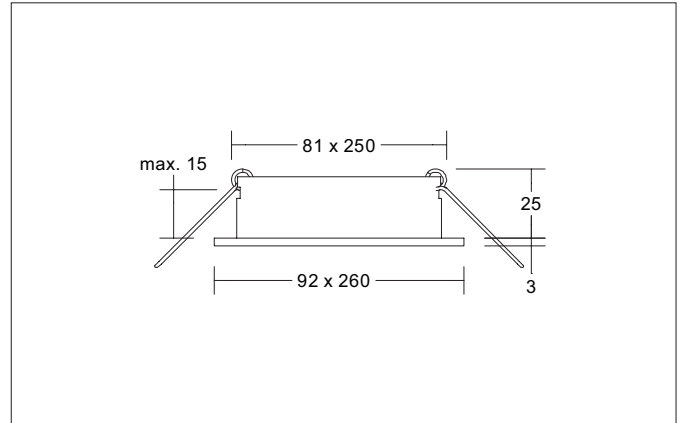

M1 Recessed housing, rectangular, flush, 3-x, recessed with module holders, pivoted

Article no. 45028550

Light.
For Generations.**Tender**

Recessed housing, rectangular, flush, 3-x, recessed with module holders, pivoted, outside white structure / inside black structure, Square. In a compact design, for installation in tool-less rapid assembly systems. All Brumberg MR16 LED modules can be used for the installation unit M1 up to the maximum specified power. The installation depth of the luminaire depends on the LED module used. The LED module is not included in the scope of delivery of the installation unit. Lamp holder: Without fitting, Mounting method: Recessed mounting, Place of installation: Ceiling-mounted, Material: Aluminium, Degree of protection: according to DIN EN 60529 IP20, Protection class: (EN 61140) III, Power: 14 W, Amount of light sources / fittings: 3 Qty, Adjustability: Pivoted, without control gear, Control: Other.

Product Benefits

- Teil des modular aufgebauten M1-Systems für Deckenein- und -anbau.
- Leergehäuse zur Aufnahme von Brumberg-LED-Modulen bis zu einer Leistung von max. 14 W.
- Als ähnliches, starres Gehäuse raumseitig auch in Ausführung IP44 lieferbar.
- Lieferbar in einfarbig strukturweiß, strukturschwarz oder in Kombination strukturweiß / strukturschwarz oder strukturschwarz / strukturweiß.
- 155 weitere Gehäuseversionen plus ca. 30 verschiedene LED-Module für diese Gehäuseversionen für alle gängigen Ansteuerungsarten.
- Darüber hinaus einlampige Versionen im Portfolio.

M1 Recessed housing, rectangular, flush, 3-x, recessed with module holders, pivoted

Article no. 45028550

Light.
For Generations.

Article data	
Article no.	45028550
GTIN	4251433931607
Series name	M1
Short description	Recessed housing, rectangular, flush, 3-x, recessed with module holders, pivoted
Material	Aluminium
Colour	White / Black
Type of surface	Structure
Shape	Square
Built-in width	250 mm
Built-in length	81 mm
Length	260 mm
Width	92 mm
Height	3 mm
Scope of delivery	Incl. module brackets, recessed, pivoted
Weight	0.401 kg

Operating technology of the luminaire	
Lamp	For LED
Lamp holder	Without fitting
Protection class	III
Degree of protection	IP20
Control	Depending on driver
Bulb change possible	Yes

Mounting technology	
Mounting method	Recessed mounting
Place of installation	Ceiling-mounted
Adjustability	Rotable and pivoted
Swivel angle	20°
Rotation angle	360°
Max. ceiling thickness	15 mm
Further references	No cover with thermal insulation material
Material cover	Without cover
Circlip	Without circlip

Packing data	
Gross weight	0.462 kg
Length of packaging	261 mm
Packaging width	116 mm
Packaging height	46 mm
Disposal at end of life	This product must not be disposed of with household waste. You are obliged, to dispose of such electrical waste separately. By disposing of electrical waste and other old or defective electronics separately, you support recycling or other forms of re-use. In that way you help to take care and to avoid that harmful substances get into the environment.

M1 Recessed housing, rectangular, flush, 3-x, recessed with module holders, pivoted

Article no. 45028550

Light.
For Generations.

Compatible LED-modules						
Article no.	Power	Beam angle	Colour temperature	Luminous flux	Input	Hight LED-Modul
12925003	3 W	38°	2.700 K	290 lm	350 mA	40 mm
12926003	3 W	38°	3.000 K	310 lm	350 mA	40 mm
12925004	3 W	38°	4.000 K	340 lm	350 mA	40 mm
12923383	6 W	38°	2.700 K	600 lm	350 mA	32 mm
12923603	6 W	60°	2.700 K	570 lm	350 mA	32 mm
12924383	6 W	38°	3.000 K	680 lm	350 mA	32 mm
12924603	6 W	60°	3.000 K	660 lm	350 mA	32 mm
12924384	6 W	38°	3.500 K	680 lm	350 mA	32 mm
12924604	6 W	60°	3.500 K	660 lm	350 mA	32 mm
12923384	6 W	38°	4.000 K	720 lm	350 mA	32 mm
12923604	6 W	60°	4.000 K	700 lm	350 mA	32 mm
12920183	6 W	18°	3.000 K	640 lm	350 mA	31 mm
12920243	6 W	24°	3.000 K	690 lm	350 mA	31 mm
12920003	6 W	38°	3.000 K	670 lm	350 mA	31 mm
12920603	6 W	60°	3.000 K	620 lm	350 mA	31 mm
12920184	6 W	18°	4.000 K	685 lm	350 mA	31 mm
12920244	6 W	24°	4.000 K	740 lm	350 mA	31 mm
12920004	6 W	38°	4.000 K	720 lm	350 mA	31 mm
12920604	6 W	60°	4.000 K	660 lm	350 mA	31 mm
12963383	6 W	38°	3.000 K - 1.800 K	460 lm	350 mA	32 mm
12963603	6 W	60°	3.000 K - 1.800 K	430 lm	350 mA	32 mm
12953003	12 W	38°	2.700 K	1,120 lm	350 mA	70 mm
12954003	12 W	38°	3.000 K	1,210 lm	350 mA	70 mm
12954004	12 W	38°	3.500 K	1,240 lm	350 mA	70 mm
12953004	12 W	38°	4.000 K	1,250 lm	350 mA	70 mm
12965003	12 W	38°	3.000 K - 1.800 K	930 lm	350 mA	70 mm
12983003	12.5 W	38°	3.000 K	920 lm	350 mA	95 mm
12823003	8 W	60°	2.850 K	900 lm	24.00 V	50 mm
12843004	8 W	60°	2.000 K - 6.500 K	640 lm	24.00 V	50 mm
18438002	8 W	60°	RGB+WW	400 lm	24.00 V	50 mm