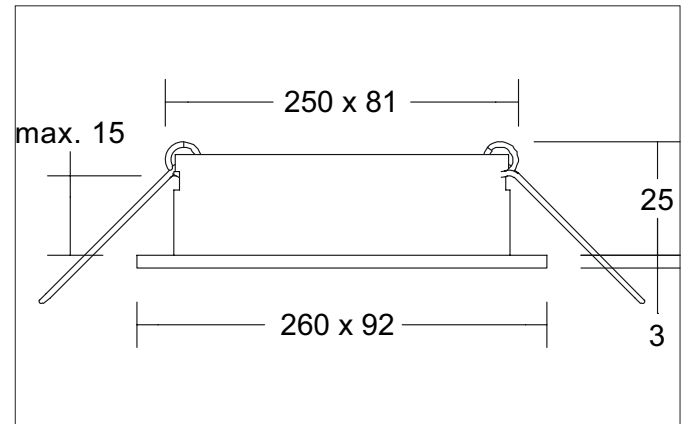

**M1 Recessed housing, rectangular, flush, 3-x, with flush module holders, pivoted**

Article no. 45026550

Light.  
For Generations.**Tender**

Recessed housing, rectangular, flush, 3-x, with flush module holders, pivoted, outside white structure / inside black structure, Square. In a compact design, for installation in tool-less rapid assembly systems. All Brumberg MR16 LED modules can be used for the installation unit M1 up to the maximum specified power. The installation depth of the luminaire depends on the LED module used. The LED module is not included in the scope of delivery of the installation unit. Lamp holder: Without fitting, Mounting method: Recessed mounting, Place of installation: Ceiling-mounted, Material: Aluminium, Degree of protection: according to DIN EN 60529 IP20, Protection class: (EN 61140) III, Power: 14 W, Amount of light sources / fittings: 3 Qty, Adjustability: Pivoted, without control gear, Control: Other.

**Product Benefits**

- Part of the modular M1 system for recessed and surface-mounted ceilings.
- Empty housing for accommodating Brumberg LED modules up to a max. output of max. 12.5 W.
- Also available as a similar, rigid housing on the room side in IP44 version.
- Available in single color textured white, textured black or in combination textured white / textured black or textured black / textured white.
- 155 further housing versions plus approx. 30 different LED modules for these housing versions for all common control types.
- Single-lamp versions also in the portfolio.

**M1 Recessed housing, rectangular, flush, 3-x, with flush module holders, pivoted**

Article no. 45026550

Light.  
For Generations.

Article data	
Article no.	45026550
GTIN	4251433931560
Series name	M1
Short description	Recessed housing, rectangular, flush, 3-x, with flush module holders, pivoted
Material	Aluminium
Colour	White / Black
Type of surface	Structure
Shape	Square
Built-in width	81 mm
Built-in length	250 mm
Length	260 mm
Width	92 mm
Height	3 mm
Scope of delivery	Incl. module brackets flush, pivoted
Weight	0.383 kg

Operating technology of the luminaire	
Lamp	For LED
Lamp holder	Without fitting
Protection class	III
Degree of protection	IP20
Control	Depending on driver
Bulb change possible	Yes

Mounting technology	
Mounting method	Recessed mounting
Place of installation	Ceiling-mounted
Adjustability	Rotable and pivoted
Swivel angle	20°
Rotation angle	360°
Max. ceiling thickness	15 mm
Further references	No cover with thermal insulation material
Material cover	Without cover
Circlip	Without circlip

Packing data	
Gross weight	0.444 kg
Length of packaging	261 mm
Packaging width	116 mm
Packaging height	46 mm
Disposal at end of life	This product must not be disposed of with household waste. You are obliged, to dispose of such electrical waste separately. By disposing of electrical waste and other old or defective electronics separately, you support recycling or other forms of re-use. In that way you help to take care and to avoid that harmful substances get into the environment.

**M1 Recessed housing, rectangular, flush, 3-x, with flush module holders, pivoted**

Article no. 45026550

Light.  
For Generations.

Compatible LED-modules						
Article no.	Power	Beam angle	Colour temperature	Luminous flux	Input	Hight LED-Modul
12925003	3 W	38°	2.700 K	290 lm	350 mA	40 mm
12926003	3 W	38°	3.000 K	310 lm	350 mA	40 mm
12925004	3 W	38°	4.000 K	340 lm	350 mA	40 mm
12923383	6 W	38°	2.700 K	600 lm	350 mA	32 mm
12923603	6 W	60°	2.700 K	570 lm	350 mA	32 mm
12924383	6 W	38°	3.000 K	680 lm	350 mA	32 mm
12924603	6 W	60°	3.000 K	660 lm	350 mA	32 mm
12924384	6 W	38°	3.500 K	680 lm	350 mA	32 mm
12924604	6 W	60°	3.500 K	660 lm	350 mA	32 mm
12923384	6 W	38°	4.000 K	720 lm	350 mA	32 mm
12923604	6 W	60°	4.000 K	700 lm	350 mA	32 mm
12920183	6 W	18°	3.000 K	640 lm	350 mA	31 mm
12920243	6 W	24°	3.000 K	690 lm	350 mA	31 mm
12920003	6 W	38°	3.000 K	670 lm	350 mA	31 mm
12920603	6 W	60°	3.000 K	620 lm	350 mA	31 mm
12920184	6 W	18°	4.000 K	685 lm	350 mA	31 mm
12920244	6 W	24°	4.000 K	740 lm	350 mA	31 mm
12920004	6 W	38°	4.000 K	720 lm	350 mA	31 mm
12920604	6 W	60°	4.000 K	660 lm	350 mA	31 mm
12963383	6 W	38°	3.000 K - 1.800 K	460 lm	350 mA	32 mm
12963603	6 W	60°	3.000 K - 1.800 K	430 lm	350 mA	32 mm
12953003	12 W	38°	2.700 K	1,120 lm	350 mA	70 mm
12954003	12 W	38°	3.000 K	1,210 lm	350 mA	70 mm
12954004	12 W	38°	3.500 K	1,240 lm	350 mA	70 mm
12953004	12 W	38°	4.000 K	1,250 lm	350 mA	70 mm
12965003	12 W	38°	3.000 K - 1.800 K	930 lm	350 mA	70 mm
12983003	12.5 W	38°	3.000 K	920 lm	350 mA	95 mm
12823003	8 W	60°	2.850 K	900 lm	24.00 V	50 mm
12843004	8 W	60°	2.000 K - 6.500 K	640 lm	24.00 V	50 mm
18438002	8 W	60°	RGB+WW	400 lm	24.00 V	50 mm