







Expert

SCHUKO plug and connector



Plug and connector for maximum mechanical loads with ABL quick-release mechanism.

-  SCHUKO standard
-  Quick-release mechanism
-  IP44
-  UV- and media resistant
-  Convenient connection space up to 2.5 mm²
-  Triple laminated seal



Plug with double earthing system

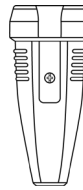

Connector with collar





General information

Colours	●	●
Product range	1509	1569
Commodity code	85366990	85366990
Packaging unit	20 unit	10 unit
Packing (l × w × h)	286 × 227 × 96 mm	248 × 161 × 140 mm
Available with increased contact protection	–	–

Electrical parameters

Current	16 A	16 A
Voltage	250 V	250 V
Number of poles	2P + PE	2P + PE

Standards/guidelines

According to standard	DIN VDE 0620 NF C61-314 NBN C61-112	DIN VDE 0620
Certification labels	  CE	  CE

Operating conditions

Storage temperature	-25 °C to +70 °C	-25 °C to +70 °C
Operating temperature	-25 °C to +40 °C	-25 °C to +40 °C
Relative humidity	5 to 95%, no condensation	5 to 95%, no condensation
IP rating	IP44, IK08	IP44, IK08
Resistance	UV- and media resistant* Very good resistance to most oils, greases, solvents and cleaning agents, hydrocarbons as well as organic and inorganic bases in normal concentrations	UV- and media resistant* Very good resistance to most oils, greases, solvents and cleaning agents, hydrocarbons as well as organic and inorganic bases in normal concentrations



Plug with double earthing system

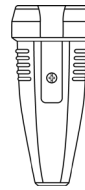

Connector with collar

Materials

Contact holder	Elamid	Elamid
Housing	Rubber (TPE)	PP, rubber (TPE) with 2K technology

Connection cable

Cross section	3 × 0.75 mm ² - 3 × 2.5 mm ²	3 × 1.00 mm ² - 3 × 2.5 mm ²
Cable diameter	6 - 12 mm	6 - 12 mm
Sheath insulation stripping length	42 - 44 mm	42 - 44 mm
Core insulation stripping length	8 - 10 mm	8 - 10 mm

Connection screws

Max. torque screws terminals L-N / PE	0.5 Nm	0.5 Nm
Screw drive terminals L-N / PE	Combined slot / PZ1	Combined slot / PZ1
Max. torque for screws housing	Quick-release mechanism 90° rotation	Quick-release mechanism 90° rotation
Screw drive housing	Combined slot / PZ1	Combined slot / PZ1
Max. torque for screws strain relief	0.5 Nm	0.5 Nm
Screw drive strain relief	Combined slot / PZ1	Combined slot / PZ1

Additional technical information

Turning the strain relief clamp	recommended for cable diameters ≤ 8 mm	recommended for cable diameters ≤ 8 mm
External screw connection	—	—



Plug with double earthing system

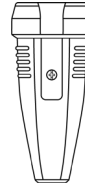

Connector with collar

Product numbers

● Black	100000043	100000054
---------	-----------	-----------

EAN/GTIN numbers

● Black	4011721188720	4011721188836
---------	---------------	---------------

Dimensional drawing – plug with double earthing system

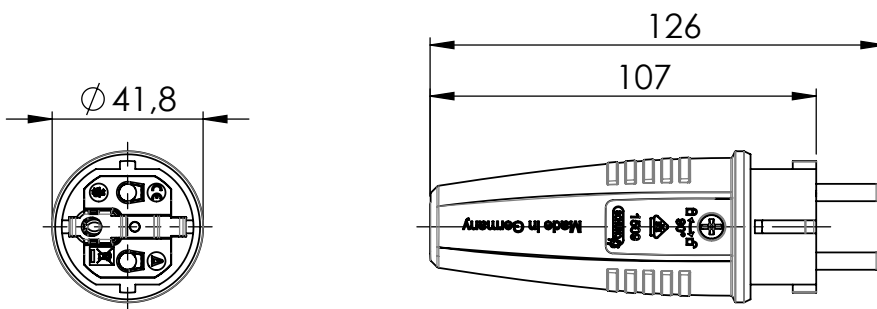

Dimensional drawing – connector without collar

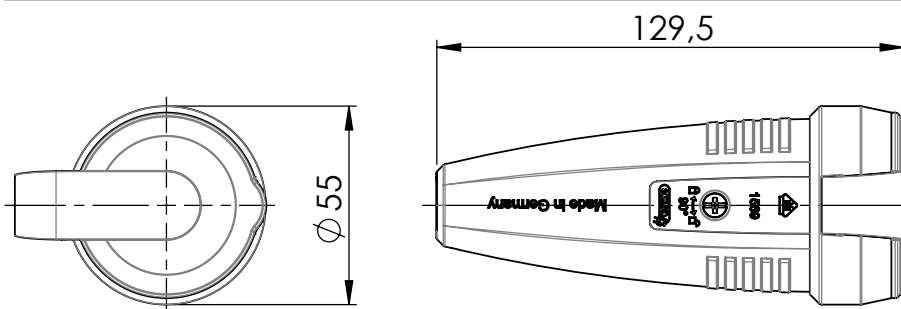

Subject to technical changes.

*If there are special requirements for the application in terms of load-bearing capacity or resistance to certain media, e.g. acid, we recommend testing the application under actual or simulated conditions of use, as parameters such as exposure time, exposure quantity and temperature in particular have a major influence.