

LED Flood Olympus

OPPLE

Version date 15-01-2023

www.opple.com

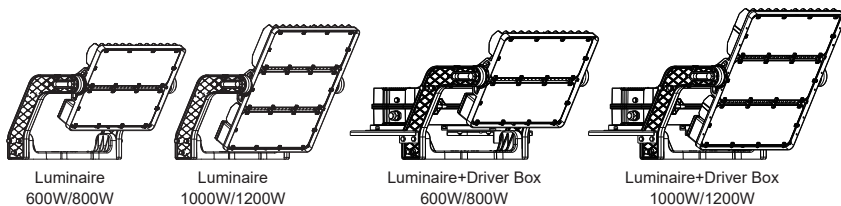

Type	Size (L×W×H)	N.G (KG)	Product Code	Product Model	CCT	Beam Angle			
Luminaire 600W	607×597×356mm	15.23	709000082500	LEDfloodOly-P Re600-600W-730-AS-LUM	3000K	38×108°			
			709000082600	LEDfloodOly-P Re600-600W-740-AS-LUM	4000K				
			709000082700	LEDfloodOly-P Re600-600W-757-AS-LUM	5700K				
			709000082800	LEDfloodOly-P Re600-600W-730-XN-LUM	3000K				
			709000082900	LEDfloodOly-P Re600-600W-740-XN-LUM	4000K	30°			
			709000083000	LEDfloodOly-P Re600-600W-757-XN-LUM	5700K				
			709000083100	LEDfloodOly-P Re600-600W-730-N-LUM	3000K	45°			
			709000083200	LEDfloodOly-P Re600-600W-740-N-LUM	4000K				
			709000083300	LEDfloodOly-P Re600-600W-757-N-LUM	5700K	60°			
			709000083400	LEDfloodOly-P Re600-600W-730-W-LUM	3000K				
			709000083500	LEDfloodOly-P Re600-600W-740-W-LUM	4000K				
			709000083600	LEDfloodOly-P Re600-600W-757-W-LUM	5700K				
			709000083700	LEDfloodOly-P Re600-800W-730-AS-LUM	3000K		38×108°		
			709000083800	LEDfloodOly-P Re600-800W-740-AS-LUM	4000K				
Luminaire 800W	607×597×356mm	15.23	709000083900	LEDfloodOly-P Re600-800W-757-AS-LUM	5700K	30°			
			709000084000	LEDfloodOly-P Re600-800W-730-XN-LUM	3000K				
			709000084100	LEDfloodOly-P Re600-800W-740-XN-LUM	4000K	45°			
			709000084200	LEDfloodOly-P Re600-800W-757-XN-LUM	5700K				
			709000084300	LEDfloodOly-P Re600-800W-730-N-LUM	3000K	60°			
			709000084400	LEDfloodOly-P Re600-800W-740-N-LUM	4000K				
			709000084500	LEDfloodOly-P Re600-800W-757-N-LUM	5700K				
			709000084600	LEDfloodOly-P Re600-800W-730-W-LUM	3000K				
			709000084700	LEDfloodOly-P Re600-800W-740-W-LUM	4000K				
			709000084800	LEDfloodOly-P Re600-800W-757-W-LUM	5700K				
			Luminaire 1000W	701×597×356mm	19.9	709000084900	LEDfloodOly-P Re700-1000W-730-AS-LUM	3000K	38×108°
						709000085000	LEDfloodOly-P Re700-1000W-740-AS-LUM	4000K	
						709000085100	LEDfloodOly-P Re700-1000W-757-AS-LUM	5700K	
						709000085200	LEDfloodOly-P Re700-1000W-730-XN-LUM	3000K	
709000085300	LEDfloodOly-P Re700-1000W-740-XN-LUM	4000K				30°			
709000085400	LEDfloodOly-P Re700-1000W-757-XN-LUM	5700K							
709000085500	LEDfloodOly-P Re700-1000W-730-N-LUM	3000K				45°			
709000085600	LEDfloodOly-P Re700-1000W-740-N-LUM	4000K							
709000085700	LEDfloodOly-P Re700-1000W-757-N-LUM	5700K				60°			
709000085800	LEDfloodOly-P Re700-1000W-730-W-LUM	3000K							
709000085900	LEDfloodOly-P Re700-1000W-740-W-LUM	4000K							
709000086000	LEDfloodOly-P Re700-1000W-757-W-LUM	5700K							
709000086100	LEDfloodOly-P Re700-1200W-730-AS-LUM	3000K					38×108°		
709000086200	LEDfloodOly-P Re700-1200W-740-AS-LUM	4000K							
Luminaire 1200W	701×597×356mm	19.9	709000086300	LEDfloodOly-P Re700-1200W-757-AS-LUM	5700K	30°			
			709000086400	LEDfloodOly-P Re700-1200W-730-XN-LUM	3000K				
			709000086500	LEDfloodOly-P Re700-1200W-740-XN-LUM	4000K				
			709000086600	LEDfloodOly-P Re700-1200W-757-XN-LUM	5700K				
			709000086700	LEDfloodOly-P Re700-1200W-730-N-LUM	3000K	45°			
			709000086800	LEDfloodOly-P Re700-1200W-740-N-LUM	4000K				
			709000086900	LEDfloodOly-P Re700-1200W-757-N-LUM	5700K	60°			
			709000087000	LEDfloodOly-P Re700-1200W-730-W-LUM	3000K				
			709000087100	LEDfloodOly-P Re700-1200W-740-W-LUM	4000K				
			709000087200	LEDfloodOly-P Re700-1200W-757-W-LUM	5700K				

Type	Driver	Size (L×W×H)	N.G (KG)	Product Code	Product Model
Driver Box-In/Out 600W		516×154×97mm	8.57	709098000700	FloodOly-P Driver-Box-In/Out-600W-DALI
Driver Box-Out 800W		458×295×171mm	13.24	709098002900	FloodOly-P Driver-Box-Out-800W-DALI
Driver Box-Out 1000W			13.4	709098000800	FloodOly-P Driver-Box-Out-1000W-DALI
Driver Box-Out 1200W			15.94	709098000900	FloodOly-P Driver-Box-Out-1200W-DALI
Driver Box-In 800W		500×159×140mm	9	709098003000	FloodOly-P Driver-Box-In-800W-DALI
Driver Box-In 1000W			9.1	709098001400	FloodOly-P Driver-Box-IN-1000W-DALI
Driver Box-In 1200W			11.75	709098001500	FloodOly-P Driver-Box-IN-1200W-DALI

Physical Dimensions (Luminaire + Driver Box) 600W

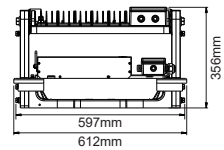
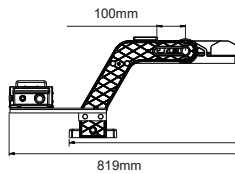
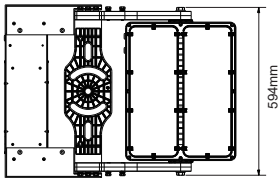

800W

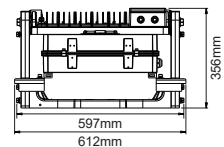
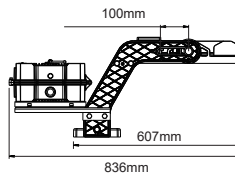
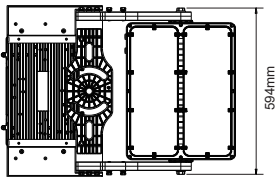

1000W/1200W

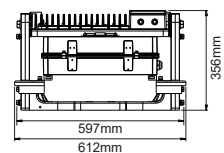
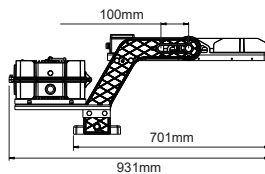
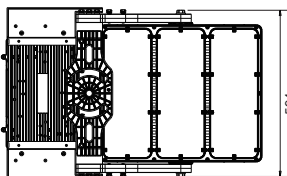

Bracket Installation

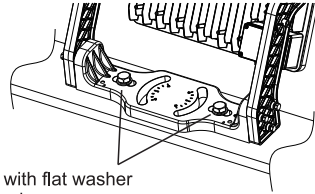
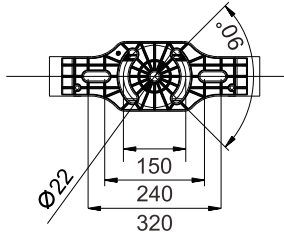
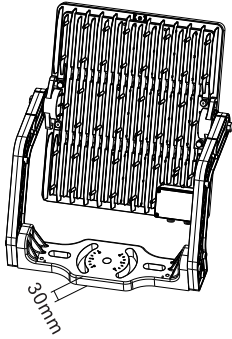

2xM20 screw with flat washer and spring washer

Not Recommended Way To Install

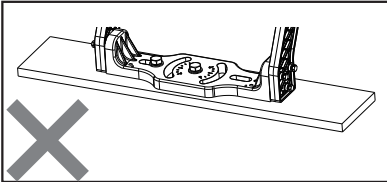
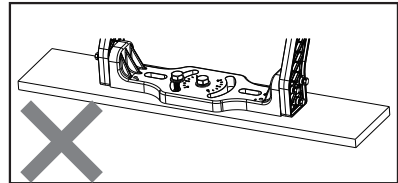
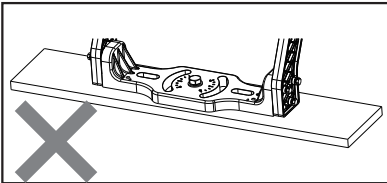

Safety Rope Installation



Safety steel wire rope
Size: $\phi 3\text{mm} \times 3\text{m}$

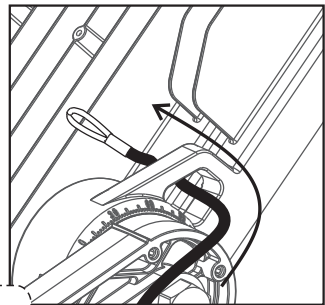

Rigging keychain
Size: $\phi 8\text{mm} \times 80\text{mm}$

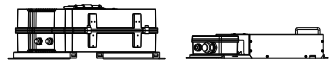
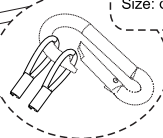
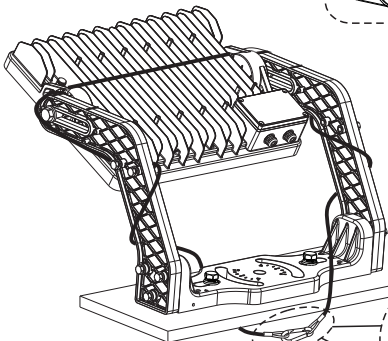

The above two driver boxes provide additional safety ropes. Please use separate safety ropes to fix driver box and site buildings tightly.

Rotatable Angle

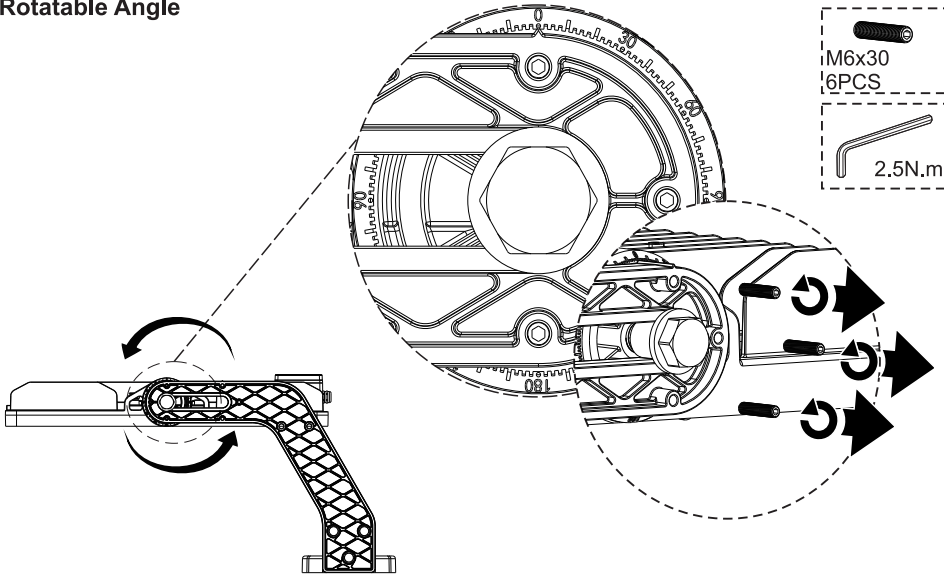

Effective Projected Area (EPA)

Unit: m ² /ft ²	Lamp Body Angle	0°	15°	30°	45°	60°	75°	90°
	600W/800W (Without Driver Box)	0.091/0.98	0.141/1.52	0.197/2.12	0.230/2.47	0.256/2.75	0.285/3.06	0.298/3.2
	1000W/1200W (Without Driver Box)	0.091/0.98	0.224/2.41	0.258/2.77	0.279/3	0.295/3.17	0.315/3.39	0.328/3.53
	600W (With Driver Box)	0.483/5.20	0.533/5.74	0.589/6.34	0.622/6.70	0.648/6.98	0.677/7.29	0.69/7.43
	800W (With Driver Box)	0.874/9.41	0.924/9.95	0.98/10.55	1.013/10.90	1.039/11.18	1.068/11.50	1.081/11.64
	1000W/1200W (With Driver Box)	0.874/9.41	0.948/10.20	1.027/11.05	1.044/11.24	1.112/11.97	1.154/12.42	1.175/12.65

Beam Angle	38×108°	30°	45°	60°
Photometric Data (For Lens)				
Luminaire mounting type	 Horizontal installation	 Vertical installation	 Vertical installation	 Vertical installation

600W Driver Box mounting Methods

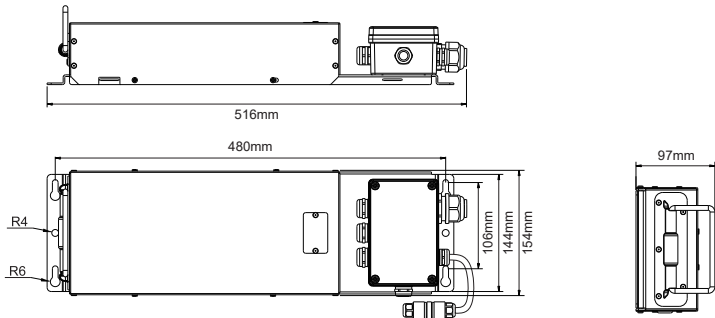

Driver Box Installation 600W on bracket

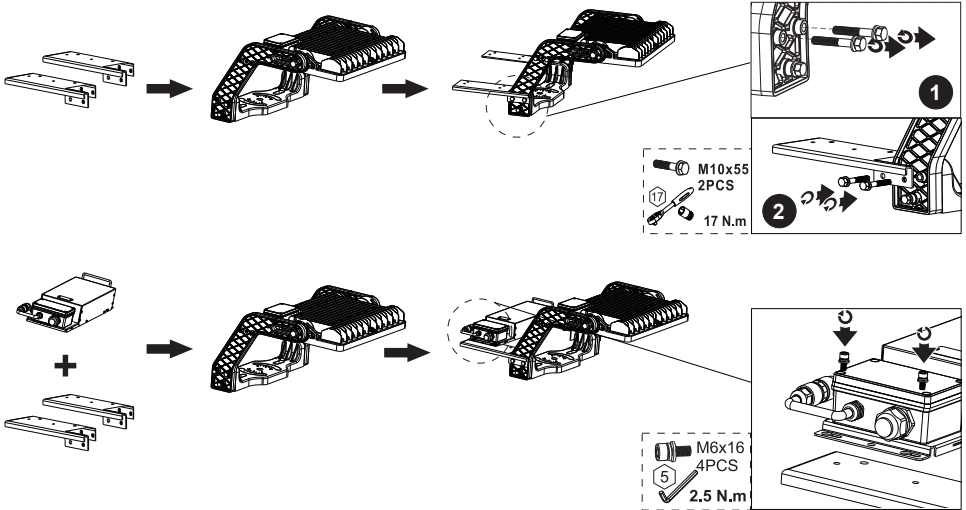

Driver Box Installation 600W on outer pole

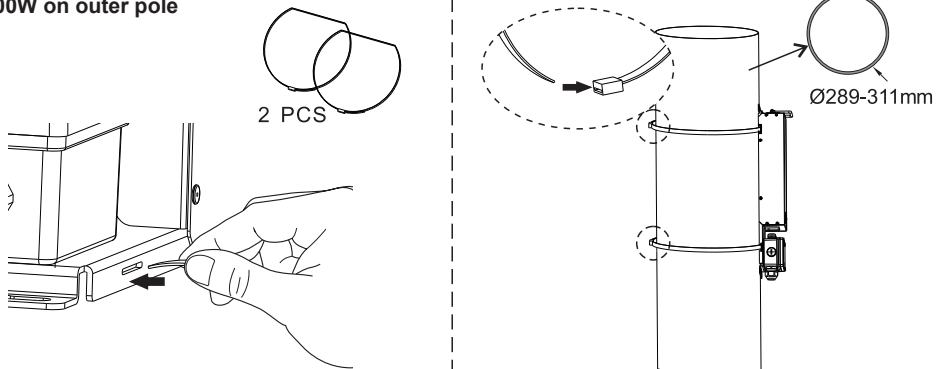

**Driver Box Installation
600W in the pole**

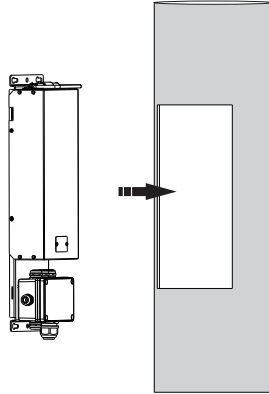

Please fix the driver box inside the pole properly and connect wires.

* Hang inside the pole, pole inner diameter should be >250mm.

**Driver Box Installation
600W Wire Connection (DALI)**

M4x20
4PCS

1.2 N.m

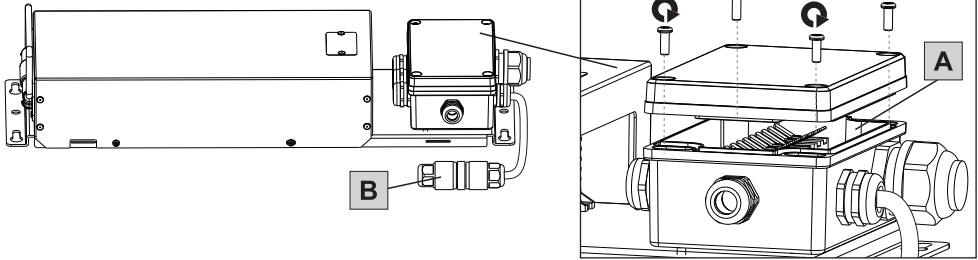

A

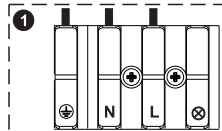
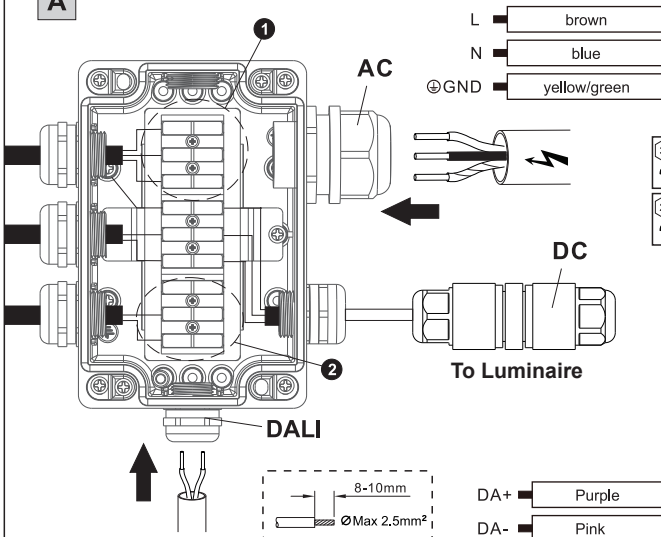

30 4 N.m

22 3.5 N.m

Input(AC)
Cable M25 (∅15-18mm)

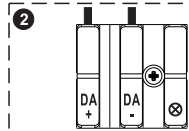

Input(DALI)
Cable M20 (∅8-12mm)

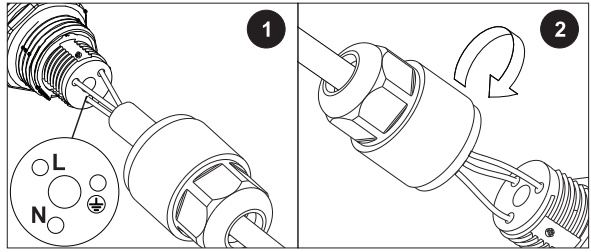
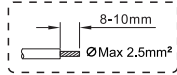
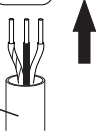
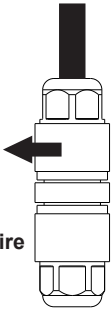
B**To Luminaire**DC Cable
Ø9-12mm

DC+ (L)	brown
DC- (N)	blue
GND (⊕)	yellow/green

Driver Box Installation 600W Wire Connection (ON-OFF)

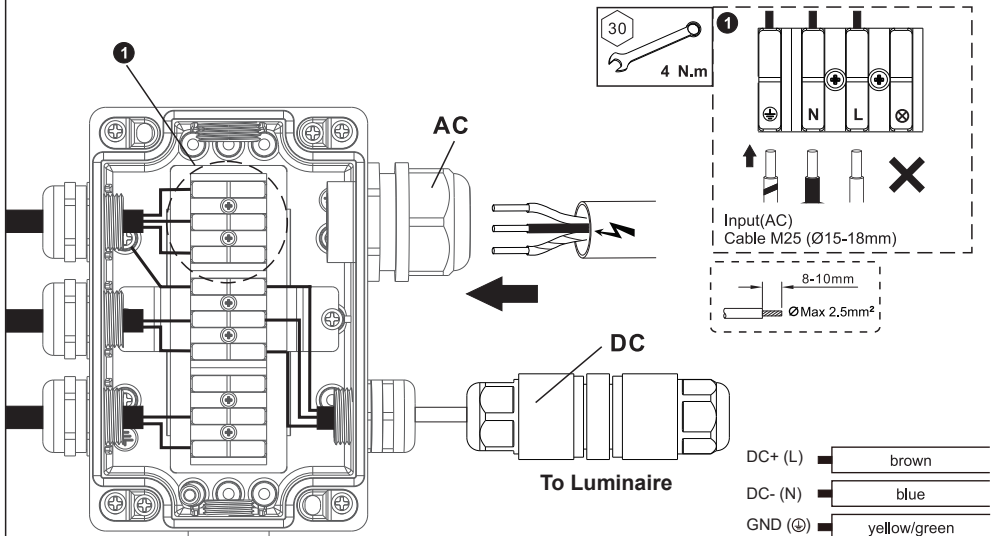
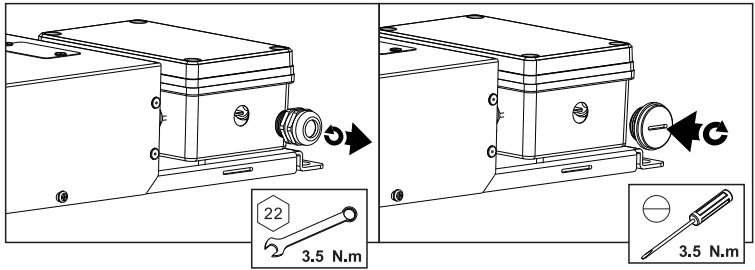

800-1200W Driver Box mounting Methods

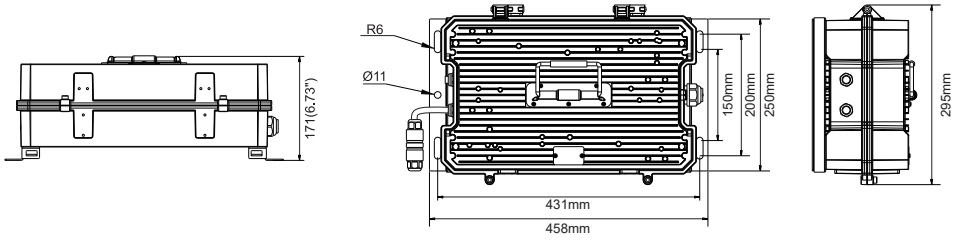

Driver Box Installation 800W/1000W/1200W on bracket

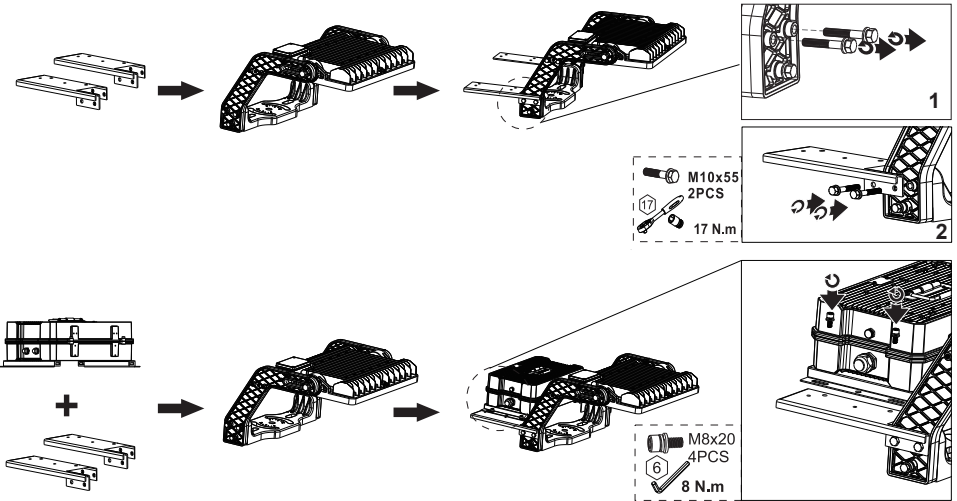

Driver Box Installation 800W/1000W/1200W on outer pole

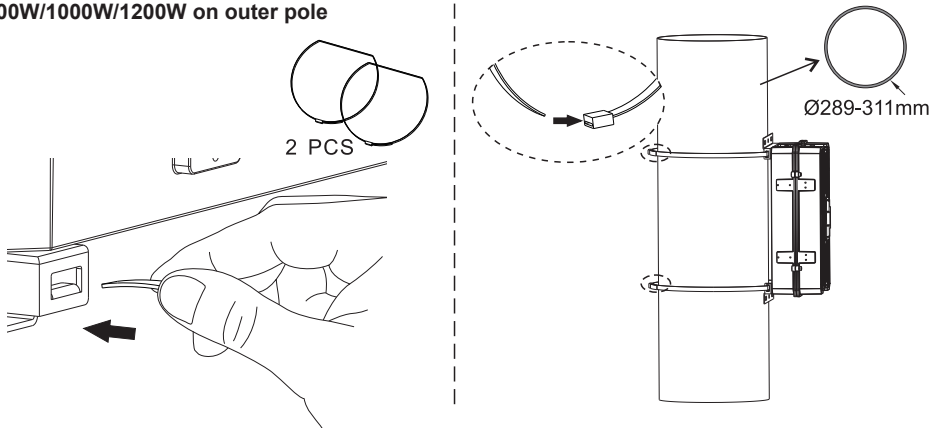

Driver Box Installation
800W/1000W/1200W in the pole

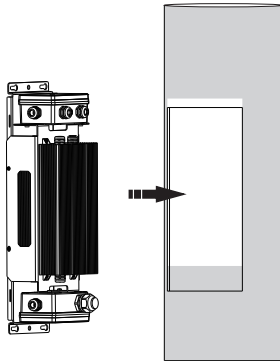
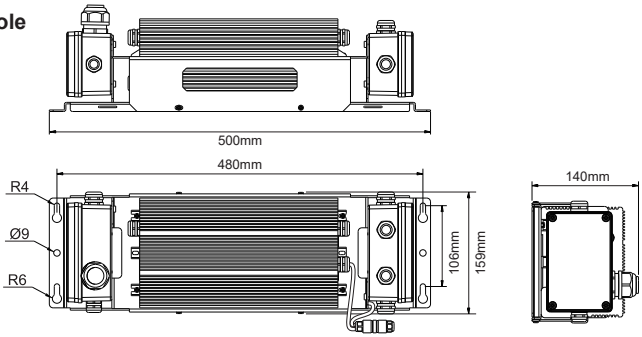

Please fix the driver box inside the pole properly and connect wires.

* Hang inside the pole, pole inner diameter should be >250mm.

Driver Box Installation
800W/1000W/1200W Wire Connection (bracket and outer pole)

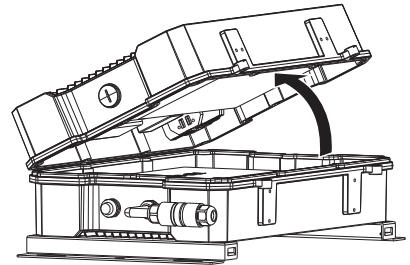
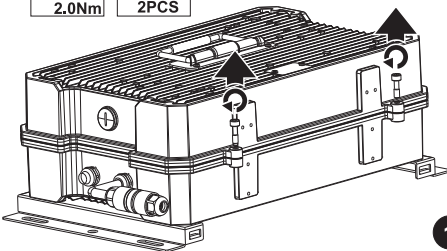
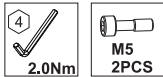

1 2

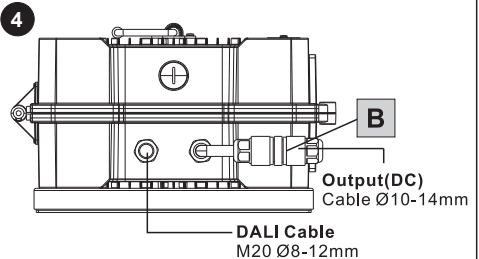
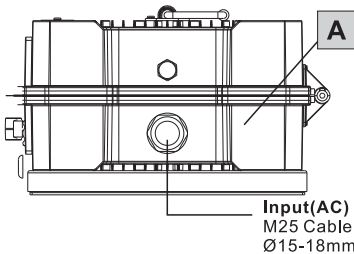

3 4

A

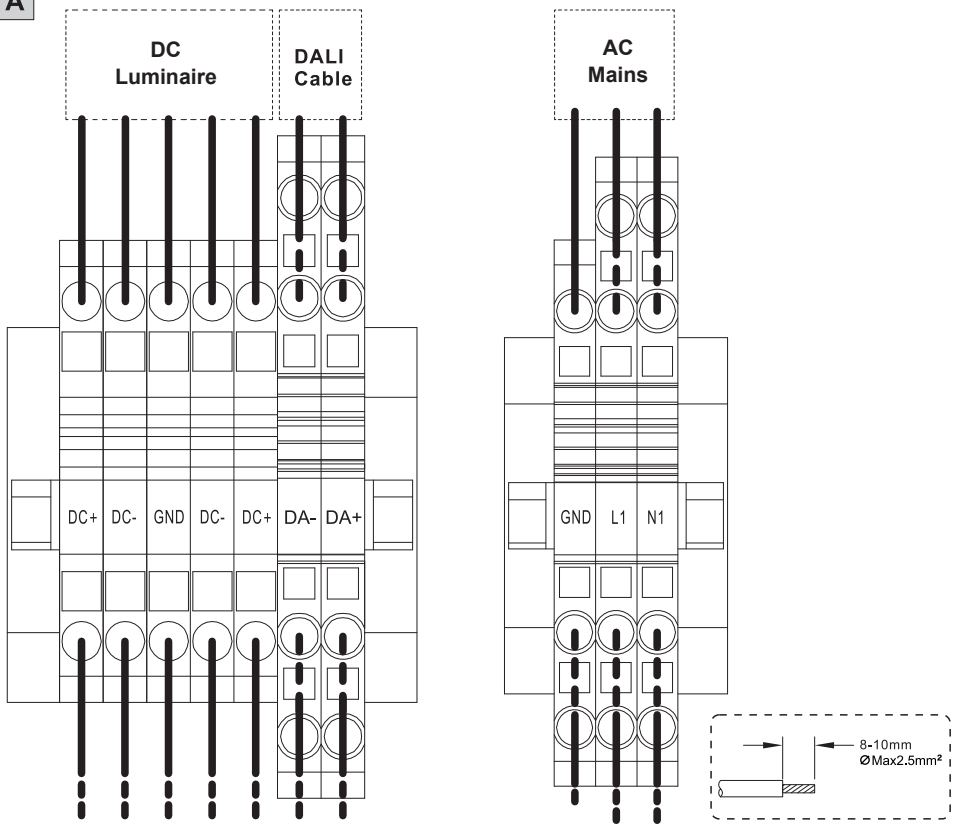

B

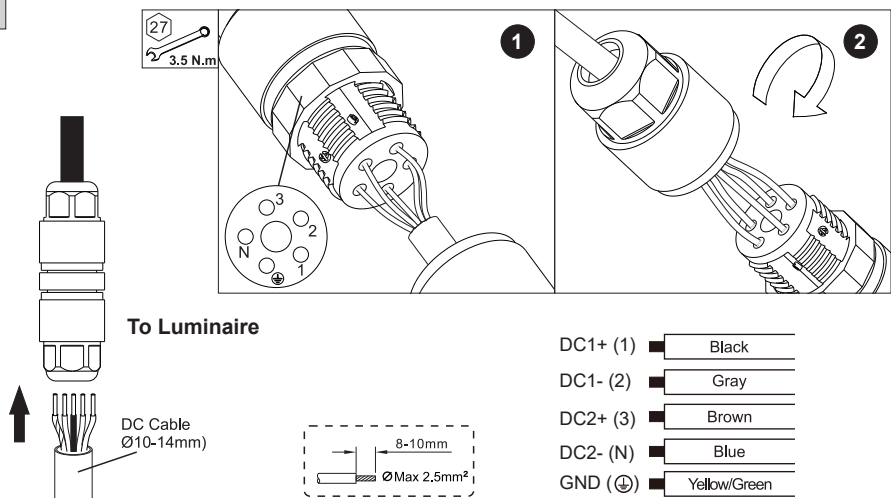

Driver Box Installation

800W/1000W/1200W Wire connection(in the pole)

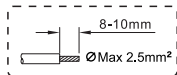

M4x20
4PCS

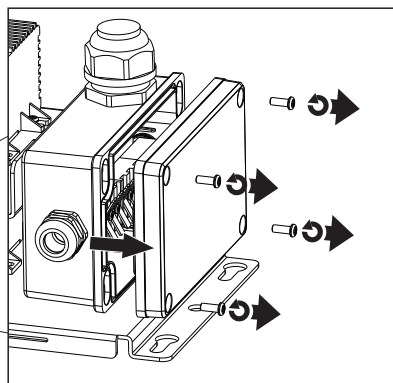
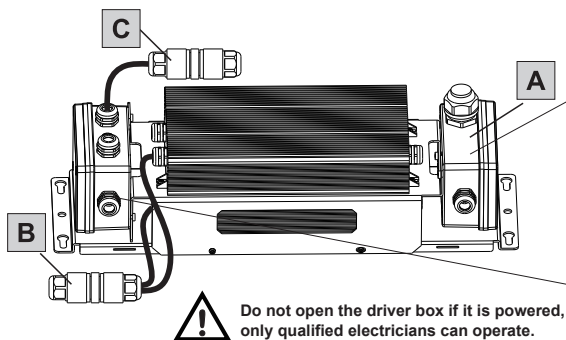

A

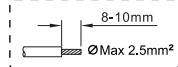
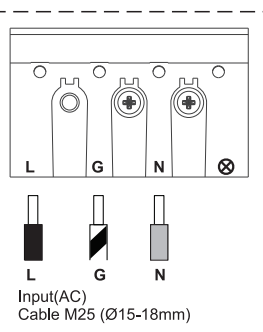
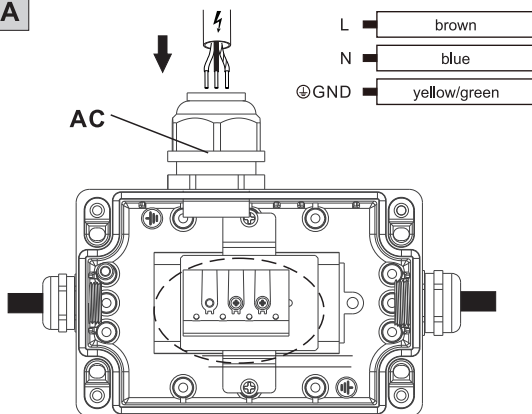

B

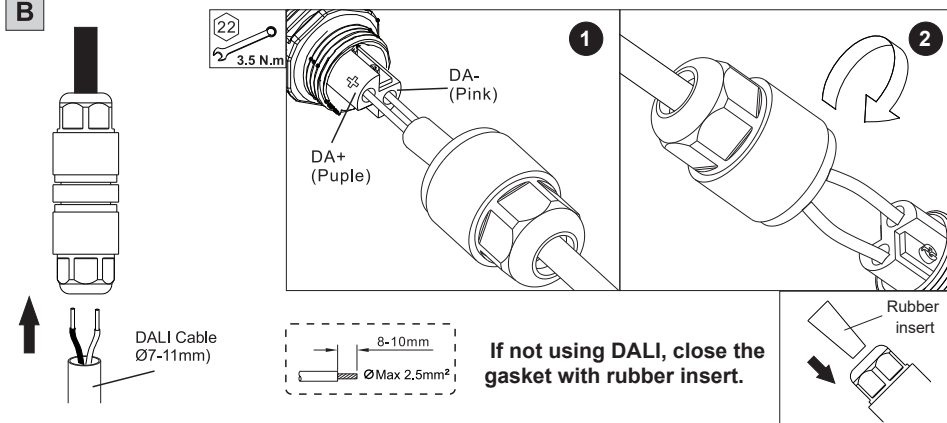

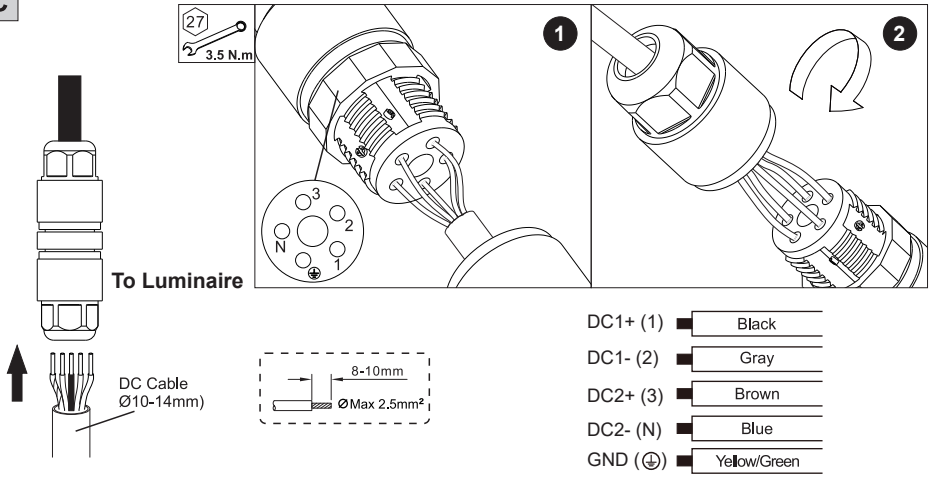
C

Driver Box Installation 800W/1000W/1200W Wire connection (ON-OFF)

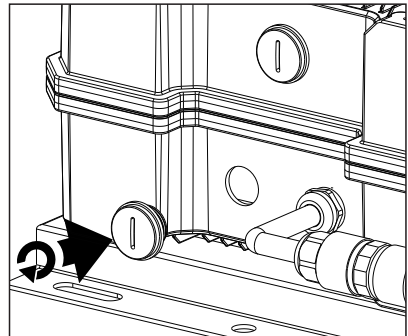
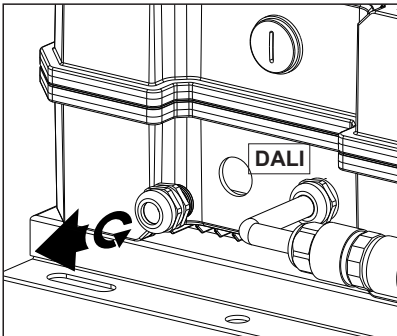

Junction Box on Luminaire (Only in case of remote driver mounting)



Cable L < 50m,
M20
Cable 50 < L < 200m,
M25

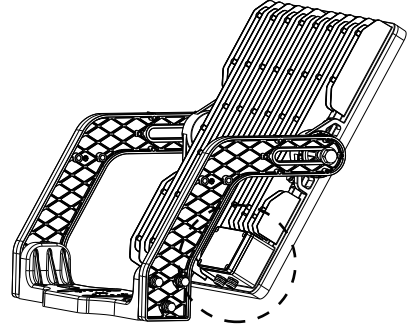
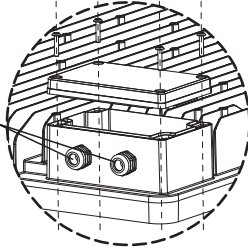

Do not open the driver box if it is powered!
Only to be operated by qualified electricians.

600W

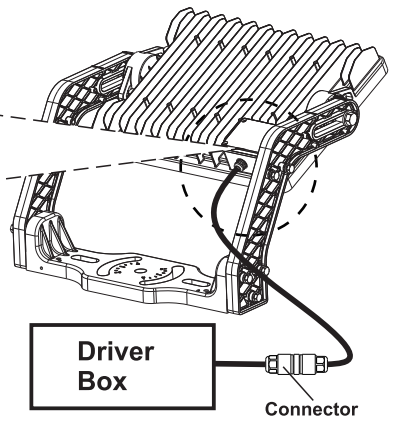
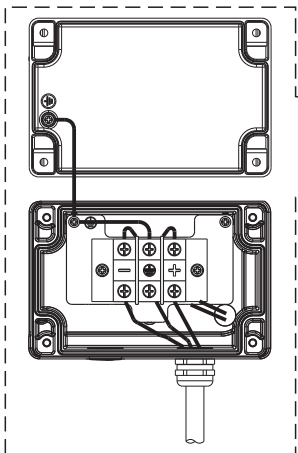

Please make sure the luminaire is properly grounded.

800W

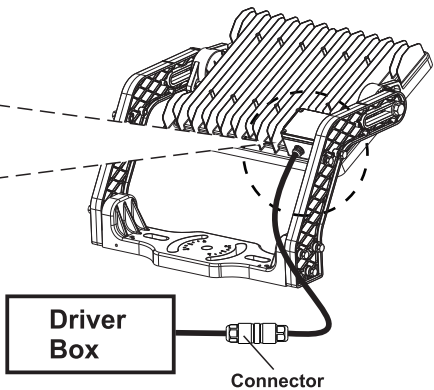
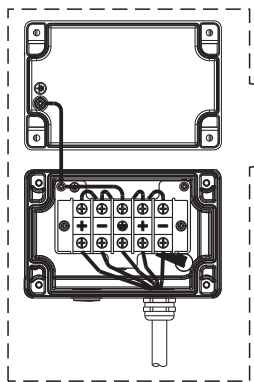

Please make sure the luminaire is properly grounded.

1000W/1200W

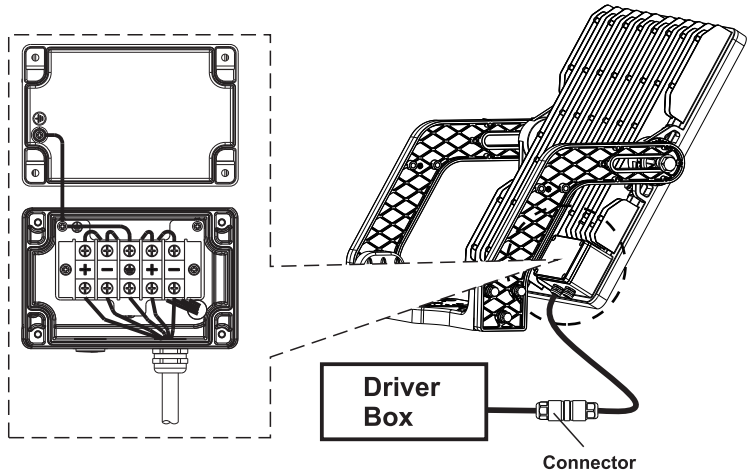

Please make sure the luminaire is properly grounded.

Carrying Capacity Of The Breaker

Lamp Type	MCB Type	Input Voltage	Quantity
600W	MCB B Type 16A	100-240V	2
	MCB B Type 32A	100-240V	4
	MCB C Type 16A	100-240V	3
	MCB C Type 32A	100-240V	7

Lamp Type	MCB Type	Input Voltage	Quantity
1000W	MCB B Type 16A	100-240V	1
	MCB B Type 32A	100-240V	2
	MCB C Type 16A	100-240V	2
	MCB C Type 32A	100-240V	4

Lamp Type	MCB Type	Input Voltage	Quantity
800W	MCB B Type 16A	100-240V	1
	MCB B Type 32A	100-240V	2
	MCB C Type 16A	100-240V	2
	MCB C Type 32A	100-240V	4

Lamp Type	MCB Type	Input Voltage	Quantity
1200W	MCB B Type 16A	100-240V	1
	MCB B Type 32A	100-240V	2
	MCB C Type 16A	100-240V	1
	MCB C Type 32A	100-240V	3



Caution: Any operation on LED module is forbidden while power-on.
Zur Vermeidung von Risiken müssen defekte Leitungen ausschließlich vom Hersteller, Inverkehrbringer oder Fachmann ausgetauscht werden. Achtung: In betrieb ist keine Arbeit am LED-Modul erlaubt.

If the external flexible cable or cord of this luminaire is damaged, it shall be exclusively replaced by the manufacturer or his service agent or a similar qualified person in order to avoid a hazard.

Wenn das externe flexible Kabel oder die Leitung dieser Leuchte beschädigt ist, darf es ausschließlich vom Hersteller oder dem Kundendienst oder einer ähnlich qualifizierten Person ersetzt werden, um Gefahren zu vermeiden.

For non-user replaceable light sources: The light source contained in this luminaire shall only be replaced by the manufacturer or his service agent or a similar qualified person.

Für nicht vom Benutzer austauschbare Lichtquellen: Die in dieser Leuchte enthaltene Lichtquelle darf nur vom Hersteller oder seinem Servicevertreter oder einer ähnlich qualifizierten Person ausgetauscht werden.



Data subject to change
Les données sont sujettes à modifications
Änderungen vorbehalten

Opplle Lighting Electronic (Zhongshan) Co.,Ltd.
Building A, No.275 Dongan Bei Road, Haizhou District,
Guzhen Town, Zhongshan City, Guangdong Province, P.R.China

Opplle Lighting B.V.
Meerenakkerweg 1-07
5652 AR Eindhoven
The Netherlands
service@opplle.com
www.opplle.com