

| | | | | |
|-----------------|----------------|-------|------------------------------|---------------------------------|
| | | | | |
| -10°C ... +70°C | -5°C ... +35°C | 40 mm | 100 ... 240 V~ 50 / 60 Hz | 8 mm 1...2,5 mm ² |

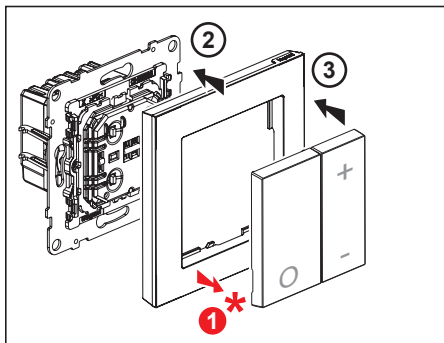

| | | 0 - 10 V | | |
|---------------|------|----------|--------|--------|
| | | | | |
| 240V~ 50Hz | Maxi | 600 VA | 600 VA | 600 VA |
| | Mini | 40 VA | 40 VA | 40 VA |
| 100V~ 60Hz | Maxi | 300 VA | 300 VA | 300 VA |
| | Mini | 40 VA | 40 VA | 40 VA |

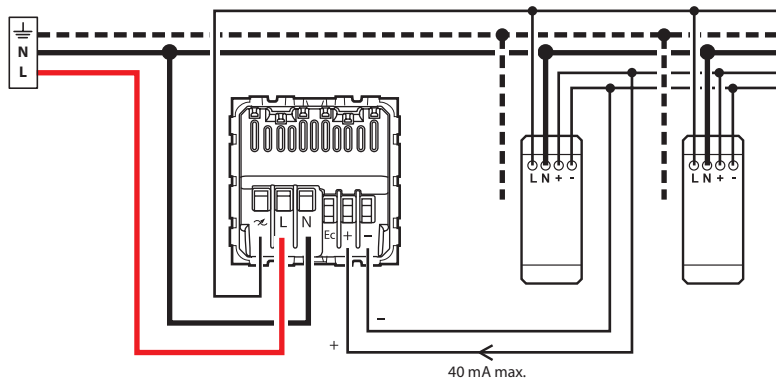

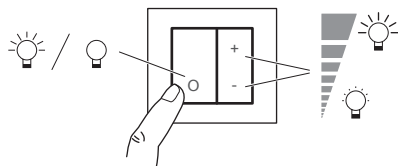
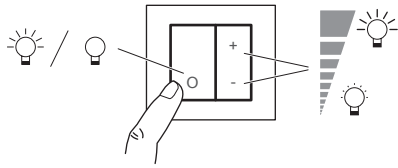
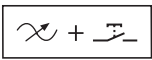

< 00:00:02

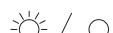

> 00:00:02

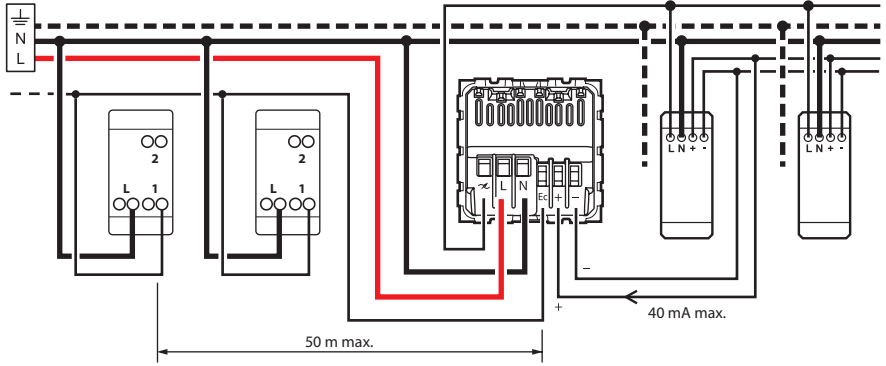

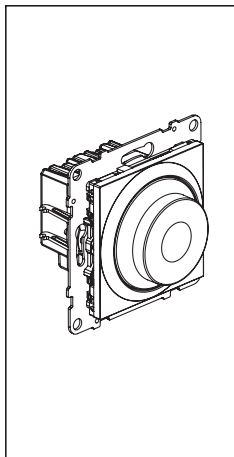

| | | | | |
|-----------------|----------------|-------|-----------------------------|----------------------------------|
| | | | U f | |
| -10°C ... +70°C | -5°C ... +35°C | 40 mm | 100 .. 240 V~ 50 / 60 Hz | 8 mm 1... 2,5 mm ² |

| | R | L | C/L | | |
|-------------------------|-----------|------------|------------|--------------------|--|
| | | | | | |
| | | | | | |
| | | | | | |
| 200-240V~ 50 / 60 Hz | 5.. 300 W | 5.. 300 VA | 5.. 300 VA | 5.. 75 W ≤ 10 x | |
| 100-200V~ 50 / 60 Hz | 5.. 150 W | 5.. 150 VA | 5.. 150 VA | 5.. 37 W ≤ 10 x | |

