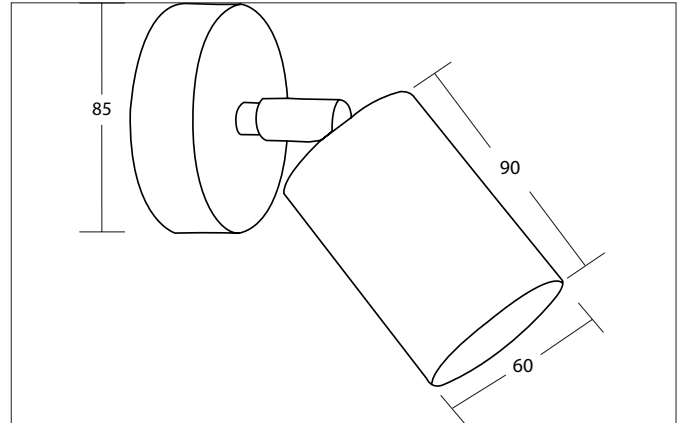

**LOMBOK Surface-mounted wall light, GU10, IP44**

Article no. 65351100

Light.  
For Generations.**Tender**

Surface-mounted wall light, GU10, IP44, Other., Hight 162.0 mm Weight 0.211 kg, with rotattionssymmetrical, deep, wide distributed light intensity.with Lamp holder GU10 max: 8 W , Delivery without bulb.Housing material: Aluminium / Glass, Colour: Graphite, Permissible ambient temperature (ta): -20 to +45°C, Protection class (EN 61140): I, Degree of protection (DIN EN 60529): IP44, .For direct connection to mains voltage, Other dimmable.

Article data	
Article no.	65351100
GTIN	4255752502708
Series name	LOMBOK
Short description	Surface-mounted wall light, GU10, IP44
Material	Aluminium / Glass
Colour	Graphite
Type of surface	Structure
Shape	Other
Hight	162 mm
Weight	0.211 kg

Lighting technology	
Light output	Direct
System efficiency	8 lm/W
Reflector	Without
Light sharing	Symmetric
Adjustable color temperature	No

**LOMBOK Surface-mounted wall light, GU10, IP44**

Article no. 65351100

Light.  
For Generations.

Operating technology of the luminaire	
System output	8 W
Voltage type	AC
AC nominal voltage max	230 V
Frequency max	50 Hz
Lamp	For LED-retrofill lamp
Lamp holder	GU10
Protection class	I
Degree of protection	IP44
Ambient temperature	-20 bis +45°C
Control	Other
Bulb change possible	Yes

Mounting technology	
Mounting method	Surface mounting
Place of installation	Wall-mounted
Adjustability	Not adjustable
Swivel angle	0°
stamp	UKCA
Further references	Outdoor
Circlip	Without circlip

Packing data	
Gross weight	0.298 kg
Length of packaging	950 mm
Packaging width	90 mm
Packaging height	170 mm
Disposal at end of life	This product must not be disposed of with household waste. You are obliged, to dispose of such electrical waste separately. By disposing of electrical waste and other old or defective electronics separately, you support recycling or other forms of re-use. In that way you help to take care and to avoid that harmful substances get into the environment.