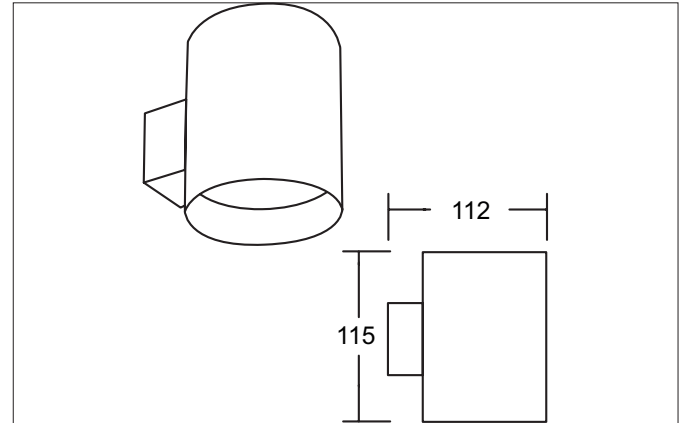

M1 Wall surface mounted housing, round, recessed, flush with module bracket, pivoted, without LED module

Article no. 45200180

Light.
For Generations.**Tender**

Wall surface mounted housing, round, recessed, flush with module bracket, pivoted, without LED module, Round. Luminaire diameter 90.0 mm, Height 115.0 mm Weight 0.282 kg, with rotationssymmetrical, deep, wide distributed light intensity with Lamp holder Without fitting max: 8 W, Delivery without bulb. Housing material: Aluminium, Colour: White structure, Permissible ambient temperature (ta): -20 °C - +25 °C, Protection class (EN 61140): III, Degree of protection (DIN EN 60529): IP20, .For connection to an external driver, which is not included in the scope of delivery of the luminaire. Depending on driver dimmable.

Article data	
Article no.	45200180
GTIN	4255752501695
Series name	M1
Short description	Wall surface mounted housing, round, recessed, flush with module bracket, pivoted, without LED module
Material	Aluminium
Colour	White
Type of surface	Structure
Shape	Round
Outer diameter	90 mm
Height	115 mm
Scope of delivery	inkl. Modulhalterung bündig, schwenkbar
Weight	0.282 kg

M1 Wall surface mounted housing, round, recessed, flush with module bracket, pivoted, without LED module

Article no. 45200180

Light.
For Generations.

Operating technology of the luminaire	
Lamp	For LED
Lamp holder	Without fitting
Protection class	III
Degree of protection	IP20
Control	Depending on driver
Bulb change possible	Yes

Mounting technology	
Mounting method	Surface mounting
Place of installation	Wall-mounted
Adjustability	Pivoted
Swivel angle	20°
stamp	UKCA
Material cover	Without cover
Circlip	Without circlip





Packing data	
Gross weight	0.324 kg
Length of packaging	100 mm
Packaging width	100 mm
Packaging height	135 mm
Disposal at end of life	This product must not be disposed of with household waste. You are obliged, to dispose of such electrical waste separately. By disposing of electrical waste and other old or defective electronics separately, you support recycling or other forms of re-use. In that way you help to take care and to avoid that harmful substances get into the environment.

Compatible LED-modules						
Article no.	Power	Beam angle	Colour temperature	Luminous flux	Input	Hight LED-Modul
12925003	3 W	38°	2.700 K	290 lm	350 mA	40 mm
12926003	3 W	38°	3.000 K	310 lm	350 mA	40 mm
12925004	3 W	38°	4.000 K	340 lm	350 mA	40 mm
12923383	6 W	38°	2.700 K	600 lm	350 mA	32 mm
12923603	6 W	60°	2.700 K	570 lm	350 mA	32 mm
12924383	6 W	38°	3.000 K	680 lm	350 mA	32 mm
12924603	6 W	60°	3.000 K	660 lm	350 mA	32 mm
12924384	6 W	38°	3.500 K	680 lm	350 mA	32 mm
12924604	6 W	60°	3.500 K	660 lm	350 mA	32 mm
12923384	6 W	38°	4.000 K	720 lm	350 mA	32 mm
12923604	6 W	60°	4.000 K	700 lm	350 mA	32 mm
12963383	6 W	38°	3.000 K - 1.800 K	460 lm	350 mA	32 mm
12963603	6 W	60°	3.000 K - 1.800 K	430 lm	350 mA	32 mm
12920183	6 W	18°	3.000 K	640 lm	350 mA	31 mm
12920243	6 W	24°	3.000 K	690 lm	350 mA	31 mm
12920003	6 W	38°	3.000 K	670 lm	350 mA	31 mm
12920603	6 W	60°	3.000 K	620 lm	350 mA	31 mm
12920184	6 W	18°	4.000 K	685 lm	350 mA	31 mm
12920244	6 W	24°	4.000 K	740 lm	350 mA	31 mm
12920004	6 W	38°	4.000 K	720 lm	350 mA	31 mm
12920604	6 W	60°	4.000 K	660 lm	350 mA	31 mm
12823003	8 W	60°	2.850 K	900 lm	24.00 V	50 mm
12843004	8 W	60°	2.000 K - 6.500 K	640 lm	24.00 V	50 mm
18438002	8 W	60°	RGB+WW	400 lm	24.00 V	50 mm
12929503	6.3 W	50°	2.700 K / 3.000 K / 4.000 K		350 mA	34 mm

M1 Wall surface mounted housing, round, recessed, flush with module bracket, pivoted, without LED module

Article no. 45200180

Light.
For Generations.

Accessories	
	Article no.: 17662000 LED converter 350 mA, on/off switchable Power: 1 - 7,2 W Dimensions: 68 mm x 35 mm x 21 mm
	Article no.: 17652000 LED-round converter 350 mA, trailing-edge phase dimmer Power: 4,9 - 7 W Dimensions: 51 mm x 24 mm
	Article no.: 17658000 LED round converter 350 mA, DALI dimmable (digital) Power: 2,1 - 9 W Dimensions: 56 mm x 25 mm
	Article no.: 17665000 LED converter 350 mA, switchable Power: 1 - 3,2 W Dimensions: 52 mm x 30 mm x 23 mm