

MUNA MINI LED recessed downlight, 3CCT, UGR < 19, trailing edge dimmable, reflector silver, bevelled
Article no. 12564073

Light.
For Generations.

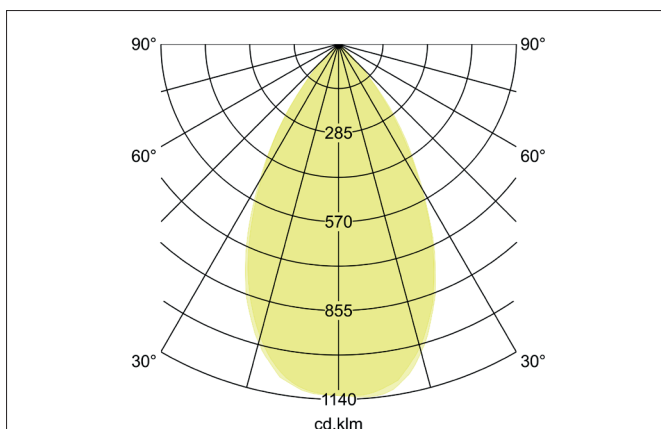
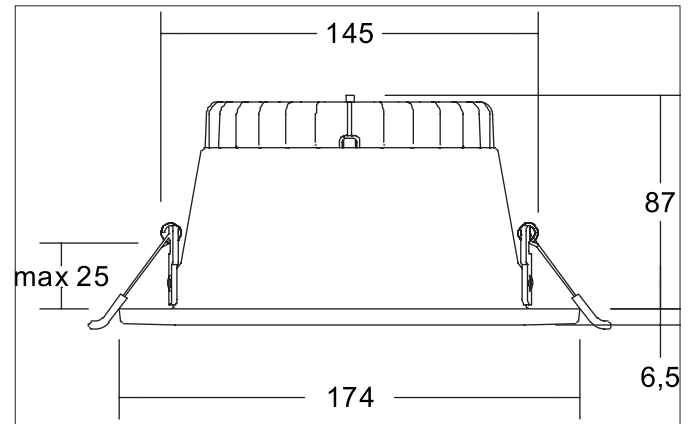

Tender

LED recessed downlight, 3CCT, UGR < 19, trailing edge dimmable, reflector silver, bevelled, Round. Toolless ceiling installation by installation springs. Ceiling cut-out Ø 145 mm, Installation depth 87 mm, Outer diameter 174 mm, Weight 0,400 kg, Reflector silver with rotationally symmetrical, deep, wide distributed light intensity. optimal light distribution due to a polycarbonate opal cover. Luminous flux 1.900 lm, UGR < 19, Power 1 x 20 W, Light colour warm white to daylight white, Correlated color temperature (CCT) 3.000 - 5.700 K, Colour rendering index CRI > 80, Rated life time L70/B10 at 25 °C: 80.000 h, Housing material: Aluminium / Polycarbonate / Steel, Colour: White, Permissible ambient temperature (ta): -20 °C - +25 °C, Protection class (EN 61140): II, Degree of protection (DIN EN 60529): IP20, .With electronic driver, Trailing-edge phase dimmable.

Product Benefits

- Rundes Einbaudownlight aus Aluminium mit großzügig dimensioniertem Wärmemanagement.
- 3CCT: 3.000 K, 4.000 K oder 5.700 K einstellbar.
- Hochwertiger Aluminiumreflektor mit Linse.
- Einfache und werkzeuglose Montage.
- UGR < 19.
- Geringe Einbautiefe von 87 mm, Durchmesser von 174 mm, Deckenausschnitt 145-155 mm.
- Phasenabschnitt dimmbar.
- Abdeckring abnehmbar und gegen schwarzen Ring austauschbar (separates Zubehör).
- Ring in rund schwarz oder rund weiß auch mit zusätzlichem, abgehängtem Floatglas (teilmattiert) lieferbar (separates Zubehör).
- Abdeckrahmen auch in quadratisch in schwarz oder weiss statt rund lieferbar (separates Zubehör).

MUNA MINI LED recessed downlight, 3CCT, UGR < 19, trailing edge dimmable, reflector silver, bevelled

Article no. 12564073

Light.
For Generations.

Article data	
Article no.	12564073
GTIN	4255752500865
Series name	MUNA MINI
Short description	LED recessed downlight, 3CCT, UGR < 19, trailing edge dimmable, reflector silver, bevelled
Material	Aluminium / Polycarbonate / Steel
Colour	White
Type of surface	Matt
Shape	Round
Outer diameter	174 mm
Built-in diameter	145 mm
Installation depth	87 mm
Hight	6.5 mm
Scope of delivery	inkl. Konverter zum Anschluss an 230 V-Netzspannung, Phasenabschnitt dimmbar mit Schalter zur Farbtemperatúrauswahl: 3.000 K / 4.000 K / 5.700 K
Weight	0.400 kg
Conformance	CE, UKCA

Lighting technology	
Colour temperature	3.000 K / 4.000 K / 5.700 K
Light output	Direct
Luminous flux	1,900 lm
System efficiency	95 lm/W
Colour rendering	CRI > 80
Reflector	Faceted
Reflector colour	silver
Beam angle	60°
Glare evaluation	UGR < 19
Light sharing	Symmetric
Adjustable color temperature	Stages

Operating technology of the luminaire	
System output	20 W
Voltage type	AC
AC nominal voltage max	230 V
Frequency max	50 Hz
Lamp	LED
Protection class	II
Degree of protection	IP20
Dimmable	Yes
Control	Trailing-edge phase
Bulb change possible	The light source of this luminaire may only be replaced by the manufacturer or a service technician commissioned by him or a similarly qualified person.









Mounting technology	
Mounting method	Recessed mounting
Place of installation	Ceiling-mounted
Adjustability	Not adjustable
Max. ceiling thickness	25 mm
Further references	No cover with thermal insulation material
Material cover	Polycarbonat opal
Suitable for through-wiring	Yes, with optional accessories

MUNA MINI LED recessed downlight, 3CCT, UGR < 19, trailing edge dimmable, reflector silver, bevelled

Article no. 12564073

Light.
For Generations.

Packing data	
Gross weight	0.583 kg
Length of packaging	190 mm
Packaging width	190 mm
Packaging height	110 mm
Disposal at end of life	This product must not be disposed of with household waste. You are obliged, to dispose of such electrical waste separately. By disposing of electrical waste and other old or defective electronics separately, you support recycling or other forms of re-use. In that way you help to take care and to avoid that harmful substances get into the environment.

Accessories	
	Article no.: 81216070 Cover frame, square, for 12564 Dimensions: 174 mm x 174 mm x 6.5 mm
	Article no.: 81216080 Cover frame, square, for 12564 Dimensions: 174 mm x 174 mm x 6.5 mm
	Article no.: 81211080 Cover ring, round, for 12564 Dimensions: 174 mm x 6.5 mm
	Article no.: 81221070 Cover ring, round, with suspended float glass, partially frosted, for 12564 Dimensions: 174 mm x 25 mm
	Article no.: 81221080 Cover ring, round, with suspended float glass, partially frosted, for 12564 Dimensions: 174 mm x 25 mm
	Article no.: 83330000 Connection box 230 V AC, 3-pole Dimensions: 80 mm x 41 mm x 34 mm
	Article no.: 81230070 Surface-mounted housing, round, for 12564 Dimensions: 182 mm x 155 mm
	Article no.: 81230080 Surface-mounted housing, round, for 12564 Dimensions: 182 mm x 155 mm