

MUNA MEGA LED recessed downlight, 3CCT, UGR < 19, trailing edge dimmable, reflector silver, bevelled
Article no. 12569073

Light.
For Generations.

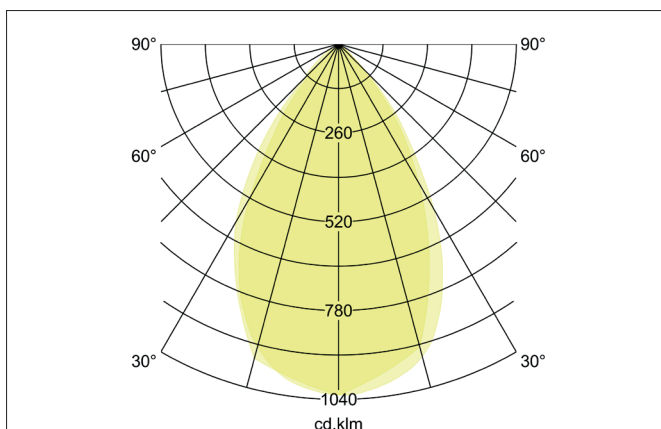
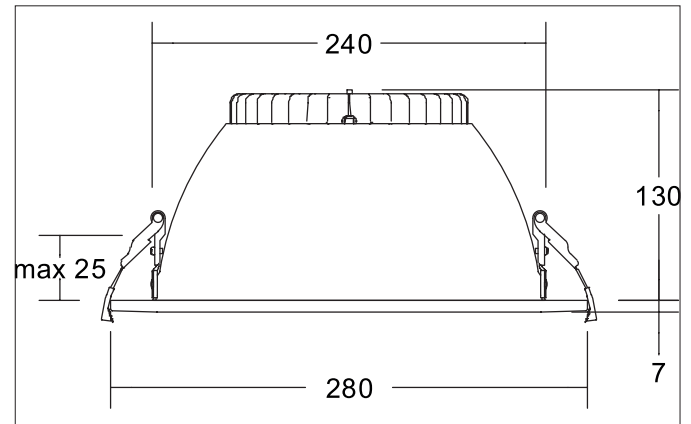

Tender

LED recessed downlight, 3CCT, UGR < 19, trailing edge dimmable, reflector silver, bevelled, Round. Toolless ceiling installation by installation springs. Ceiling cut-out Ø 240 mm, Installation depth 130 mm, Outer diameter 280 mm, Weight 0,875 kg, Reflector silver with rotationssymmetrical, deep, wide distributed light intensity. optimal light distribution due to a polycarbonat opal cover. Luminous flux 4.750 lm, UGR < 19, Power 1 x 50 W, Light colour warm white to daylight white, Correlated color temperature (CCT) 3.000 - 5.700 K, Colour rendering index CRI > 80, Rated life time L70/B10 at 25 °C: 80.000 h, Housing material: Aluminium / Polycarbonate / Steel, Colour: White, Permissible ambient temperature (ta): -20 °C - +25 °C, Protection class (EN 61140): II, Degree of protection (DIN EN 60529): IP20, .With electronic driver, Trailing-edge phase dimmable.

Product Benefits

- Rundes Einbaudownlight aus Aluminium mit großzügig dimensioniertem Wärmemanagement.
- 3CCT: 3.000 K, 4.000 K oder 5.700 K einstellbar.
- Hochwertiger Aluminiumreflektor mit Linse.
- Einfache und werkzeuglose Montage.
- UGR < 19.
- Geringe Einbautiefe von 130 mm, Durchmesser von 280 mm, Deckenausschnitt 240-255 mm.
- Phasenabschnitt dimmbar.
- Abdeckring abnehmbar und gegen schwarzen Ring austauschbar (separates Zubehör).
- Ring in rund schwarz oder rund weiß auch mit zusätzlichem, abgehängtem Floatglas (teilmattiert) lieferbar (separates Zubehör).
- Abdeckrahmen auch in quadratisch in schwarz oder weiss statt rund lieferbar (separates Zubehör).

MUNA MEGA LED recessed downlight, 3CCT, UGR < 19, trailing edge dimmable, reflector silver, bevelled

Article no. 12569073

Light.
For Generations.

Article data	
Article no.	12569073
GTIN	4255752500896
Series name	MUNA MEGA
Short description	LED recessed downlight, 3CCT, UGR < 19, trailing edge dimmable, reflector silver, bevelled
Material	Aluminium / Polycarbonate / Steel
Colour	White
Type of surface	Matt
Shape	Round
Outer diameter	280 mm
Built-in diameter	240 mm
Installation depth	130 mm
Hight	7 mm
Scope of delivery	inkl. Konverter zum Anschluss an 230 V-Netzspannung, Phasenabschnitt dimmbar mit Schalter zur Farbtemperaturauswahl: 3.000 K / 4.000 K / 5.700 K
Weight	0.875 kg
Conformance	CE, UKCA

Lighting technology	
Colour temperature	3.000 K / 4.000 K / 5.700 K
Light output	Direct
Luminous flux	4,750 lm
System efficiency	95 lm/W
Colour rendering	CRI > 80
Reflector	Faceted
Reflector colour	silver
Beam angle	60°
Glare evaluation	UGR < 19
Light sharing	Symmetric
Adjustable color temperature	Stages

Operating technology of the luminaire	
System output	50 W
Voltage type	AC
AC nominal voltage max	230 V
Frequency max	50 Hz
Lamp	LED
Protection class	II
Degree of protection	IP20
Dimmable	Yes
Control	Trailing-edge phase
Bulb change possible	The light source of this luminaire may only be replaced by the manufacturer or a service technician commissioned by him or a similarly qualified person.







Mounting technology	
Mounting method	Recessed mounting
Place of installation	Ceiling-mounted
Adjustability	Not adjustable
Max. ceiling thickness	25 mm
Further references	No cover with thermal insulation material
Material cover	Polycarbonat opal
Suitable for through-wiring	Yes, with optional accessories

MUNA MEGA LED recessed downlight, 3CCT, UGR < 19, trailing edge dimmable, reflector silver, bevelled

Article no. 12569073

Light.
For Generations.

Packing data	
Gross weight	1.375 kg
Length of packaging	305 mm
Packaging width	305 mm
Packaging height	155 mm
Disposal at end of life	This product must not be disposed of with household waste. You are obliged, to dispose of such electrical waste separately. By disposing of electrical waste and other old or defective electronics separately, you support recycling or other forms of re-use. In that way you help to take care and to avoid that harmful substances get into the environment.

Accessories	
	Article no.: 81219080 Cover frame, square, for 12569 Dimensions: 280 mm x 280 mm x 7 mm
	Article no.: 81219070 Cover frame, square, for 12569 Dimensions: 280 mm x 280 mm x 7 mm
	Article no.: 81214080 Cover ring, round, for 12569 Dimensions: 280 mm x 7 mm
	Article no.: 81224070 Cover ring, round, with suspended float glass, partially frosted, for 12569 Dimensions: 280 mm x 30 mm
	Article no.: 81224080 Cover ring, round, with suspended float glass, partially frosted, for 12569 Dimensions: 280 mm x 30 mm
	Article no.: 83330000 Connection box 230 V AC, 3-pole Dimensions: 80 mm x 41 mm x 34 mm