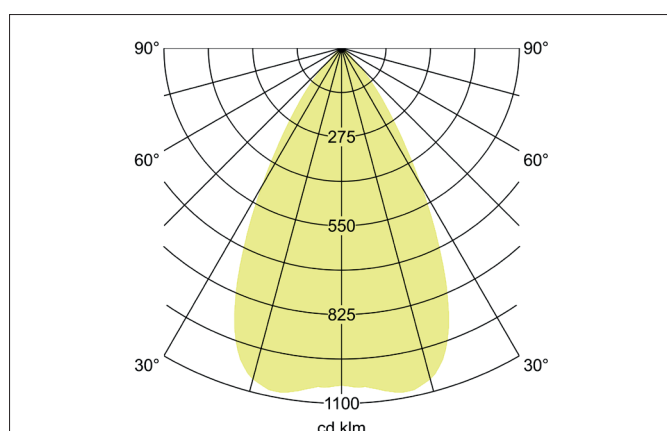
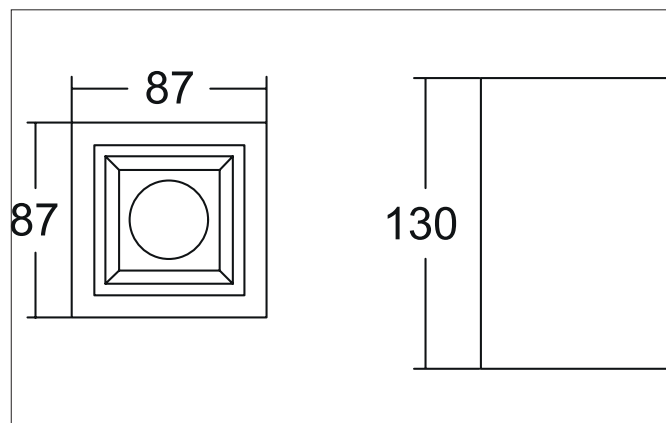

**APOLLO MICRO LED downlight, reflector faceted, DALI dimmable**

Article no. 43641175DA

Light.  
For Generations.**Tender**

LED downlight, reflector faceted, DALI dimmable, Square. Luminaire length 87.0 mm, Luminaire width 87.0 mm, Height 130.0 mm Weight 0.537 kg, Reflector silver with rotationssymmetrical, deep, wide distributed light intensity. optimal light distribution due to a plastic, transparent cover. Luminous flux 873 lm, UGR < 19, Power 1 x 7 W, Light colour neutral white, Correlated color temprature (CCT) 3.500 K, Colour rendering index CRI > 90, Rated life time L80/B10 at 25 °C: 50.000 h, Housing material: Aluminium / Glass / Plastic, Colour: White, Permissible ambient temperature (ta): -20 °C - +25 °C, Protection class (EN 61140): I, Degree of protection (DIN EN 60529): IP20, .With electronic driver, DALI-2 dimmable.

Article data	
Article no.	43641175DA
GTIN	4255752506409
Series name	APOLLO MICRO
Short description	LED downlight, reflector faceted, DALI dimmable
Material	Aluminium / Glass / Plastic
Colour	White
Type of surface	Structure
Shape	Square
Length	87 mm
Width	87 mm
Hight	130 mm
Weight	0.537 kg

**APOLLO MICRO LED downlight, reflector faceted, DALI dimmable**

Article no. 43641175DA

Light.  
For Generations.

Lighting technology	
Colour temperature	3.500 K
Light colour	White
Light output	Direct
Luminous flux	873 lm
System efficiency	125 lm/W
McAdam-Step	McAdam-Step 3
Colour rendering	CRI > 90
Reflector	Faceted
Reflector colour	silver
Beam angle	55°
Glare evaluation	UGR < 19
Light sharing	Symmetric
Adjustable color temperature	No

Operating technology of the luminaire	
System output	7 W
Voltage type	AC
AC nominal voltage max	230 V
Frequency max	50 Hz
Lamp	LED
Lamp holder	LED
Protection class	I
Degree of protection	IP20
Control	DALI-2
Bulb change possible	The light source of this luminaire may only be replaced by the manufacturer or a service technician commissioned by him or a similarly qualified person.
Rated life time L80/B10 at 25 °C	50.000 h

Mounting technology	
Mounting method	Surface mounting
Place of installation	Ceiling-mounted
Adjustability	Not adjustable
stamp	UKCA
Material cover	Plastic, transparent
Suitable for through-wiring	No

Packing data	
Gross weight	0.638 kg
Length of packaging	220 mm
Packaging width	105 mm
Packaging height	110 mm
Disposal at end of life	This product must not be disposed of with household waste. You are obliged, to dispose of such electrical waste separately. By disposing of electrical waste and other old or defective electronics separately, you support recycling or other forms of re-use. In that way you help to take care and to avoid that harmful substances get into the environment.