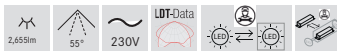
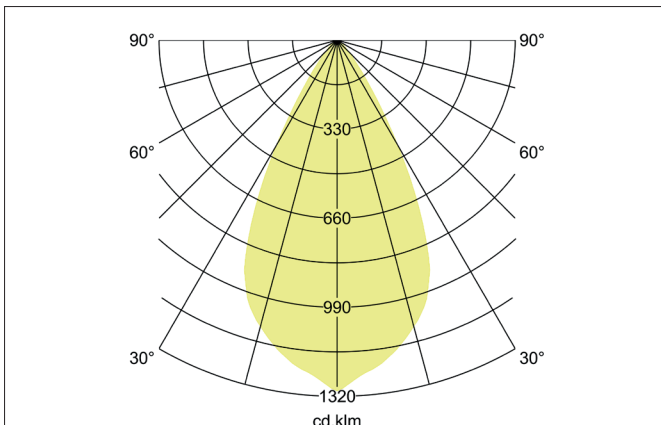
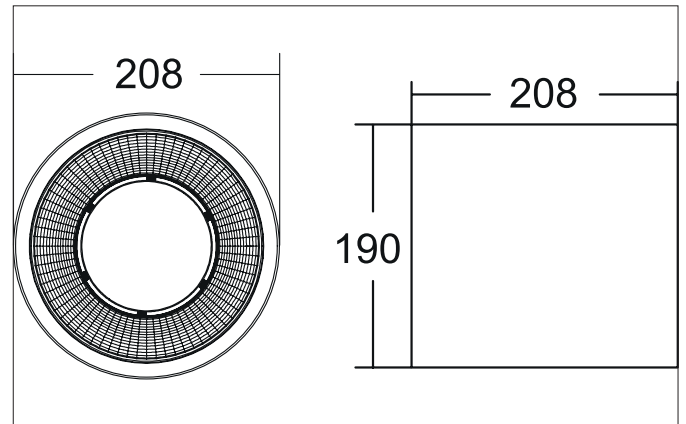

APOLLO MAXI LED downlight, reflector smooth, on/off

Article no. 42614175

Tender

LED downlight, reflector smooth, on/off, Round. Luminaire diameter 208.0 mm, Height 190.0 mm Weight 2.178 kg, Reflector silver with rotationssymmetrical, deep, wide distributed light intensity. Cover plastic, transparent. Luminous flux 2.655 lm, UGR < 19, Power 1 x 20,5 W, System Efficiency lm/W, Light colour neutral white, Correlated color temprature (CCT) 3.500 K, Colour rendering index CRI > 90, Rated life time L80/B10 at 25 °C: 50.000 h, Housing material: Aluminium / Glass / Plastic, Colour: White, Permissible ambient temperature (ta): -20 °C - +25 °C, Protection class (EN 61140): I, Degree of protection (DIN EN 60529): IP20. With electronic driver, on/off switchable.

Article data	
Article no.	42614175
GTIN	4255752506539
Series name	APOLLO MAXI
Short description	LED downlight, reflector smooth, on/off
Material	Aluminium / Glass / Plastic
Colour	White
Type of surface	Structure
Shape	Round
Outer diameter	208 mm
Height	190 mm
Weight	2.178 kg
Conformance	CE, UKCA

APOLLO MAXI LED downlight, reflector smooth, on/off

Article no. 42614175

Lighting technology	
Colour temperature	3.500 K
Light colour	White
Light output	Direct
Luminous flux	2,655 lm
System efficiency	130 lm/W
McAdam-Step	McAdam-Step 3
Colour rendering	CRI > 90
Reflector	High-gloss
Reflector colour	silver
Beam angle	55°
Glare evaluation	UGR < 19
Light sharing	Symmetric
Adjustable color temperature	No

Operating technology of the luminaire	
System output	20.5 W
Voltage type	AC
AC nominal voltage max	230 V
Frequency max	50 Hz
Lamp	LED
Lamp holder	LED
Protection class	I
Degree of protection	IP20
Control	on/off
Bulb change possible	The light source of this luminaire may only be replaced by the manufacturer or a service technician commissioned by him or a similarly qualified person.
Rated life time L80/B10 at 25 °C	50.000 h

Mounting technology	
Mounting method	Surface mounting
Place of installation	Ceiling-mounted
Adjustability	Not adjustable
Material cover	Plastic, transparent
Suitable for through-wiring	No

Packing data	
Gross weight	2.436 kg
Length of packaging	210 mm
Packaging width	210 mm
Packaging height	195 mm
Disposal at end of life	This product must not be disposed of with household waste. You are obliged, to dispose of such electrical waste separately. By disposing of electrical waste and other old or defective electronics separately, you support recycling or other forms of re-use. In that way you help to take care and to avoid that harmful substances get into the environment.