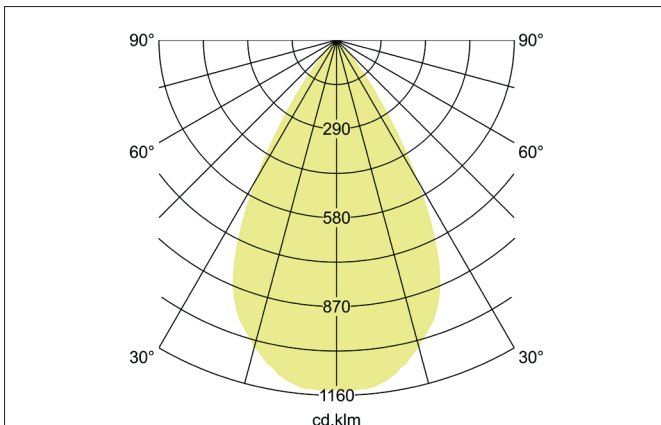
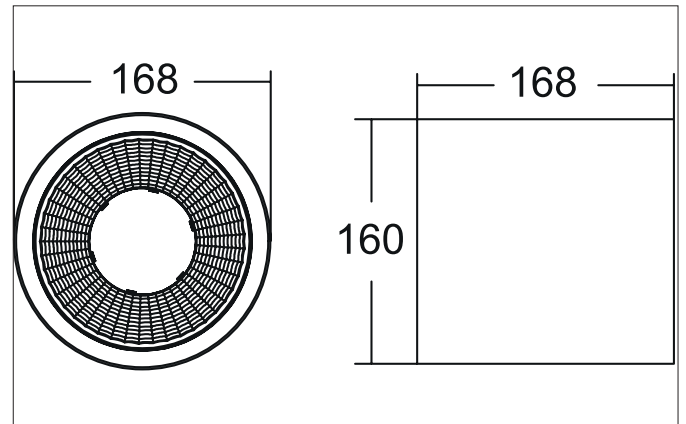

APOLLO MIDI LED downlight, reflector smooth, DALI dimmable

Article no. 42613184DA

Light.
For Generations.**Tender**

LED downlight, reflector smooth, DALI dimmable, Round. Luminaire diameter 168.0 mm, Height 160.0 mm Weight 1.272 kg, Reflector silver with rotationssymmetrical, deep, wide distributed light intensity. optimal light distribution due to a plastic, transparent cover. Luminous flux 1.915 lm, UGR < 19, Power 1 x 14,5 W, Light colour neutral white, Correlated color temperature (CCT) 4.000 K, Colour rendering index CRI > 90, Rated life time L80/B10 at 25 °C: 50.000 h, Housing material: Aluminium / Glass / Plastic, Colour: Black, Permissible ambient temperature (ta): -20 °C - +25 °C, Protection class (EN 61140): I, Degree of protection (DIN EN 60529): IP20, .With electronic driver, DALI-2 dimmable.

Article data	
Article no.	42613184DA
GTIN	4255752507161
Series name	APOLLO MIDI
Short description	LED downlight, reflector smooth, DALI dimmable
Material	Aluminium / Glass / Plastic
Colour	Black
Type of surface	Structure
Shape	Round
Outer diameter	168 mm
Height	160 mm
Weight	1.272 kg

APOLLO MIDI LED downlight, reflector smooth, DALI dimmable

Article no. 42613184DA

Light.
For Generations.

Lighting technology	
Colour temperature	4.000 K
Light colour	White
Light output	Direct
Luminous flux	1,915 lm
System efficiency	132 lm/W
McAdam-Step	McAdam-Step 3
Colour rendering	CRI > 90
Reflector	High-gloss
Reflector colour	silver
Beam angle	55°
Glare evaluation	UGR < 19
Light sharing	Symmetric
Adjustable color temperature	No

Operating technology of the luminaire	
System output	14.5 W
Voltage type	AC
AC nominal voltage max	230 V
Frequency max	50 Hz
Lamp	LED
Lamp holder	LED
Protection class	I
Degree of protection	IP20
Control	DALI-2
Bulb change possible	The light source of this luminaire may only be replaced by the manufacturer or a service technician commissioned by him or a similarly qualified person.
Rated life time L80/B10 at 25 °C	50.000 h

Mounting technology	
Mounting method	Surface mounting
Place of installation	Ceiling-mounted
Adjustability	Not adjustable
stamp	UKCA
Material cover	Plastic, transparent
Suitable for through-wiring	No

Packing data	
Gross weight	1.476 kg
Length of packaging	195 mm
Packaging width	190 mm
Packaging height	220 mm
Disposal at end of life	This product must not be disposed of with household waste. You are obliged, to dispose of such electrical waste separately. By disposing of electrical waste and other old or defective electronics separately, you support recycling or other forms of re-use. In that way you help to take care and to avoid that harmful substances get into the environment.