

Montageanleitung

Ⓒ mounting instruction Ⓕ Notice de montage Ⓒ Instrukcja montażu
Ⓔ Instrucciones de montaje ⓘ Istruzioni di montaggio

RLS1-ND/DA

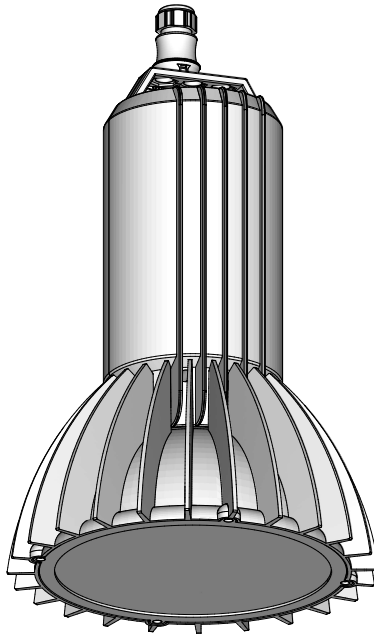

RIDI Leuchten GmbH
Hauptstrasse 31 - 33 · D-72417Jungingen
Tel. 07477/872-0 · Fax 07477/872-48
kontakt@ridi.de · www.ridi.de



- (D) Für die Installation und für den Betrieb der Leuchten sind die nationalen Sicherheitsvorschriften zu beachten.
- (GB) Please note national safety instructions for installation and operation of this luminaire.
- (F) Pour l'installation et le fonctionnement des luminaires il est impératif de respecter les normes nationales de sécurité en vigueur.
- (PL) W celu prawidłowej instalacji i poprawnego działania oprawy należy przestrzegać krajowych przepisów bezpieczeństwa.
- (E) Para la instalación y la puesta en funcionamiento de las luminarias deben observarse las normas nacionales de seguridad.
- (I) Per l'installazione e il funzionamento delle lampade si fa riferimento alle normative di sicurezza nazionali.
-

- (D) Verwendung der Leuchte in einer Umgebung, in der eine Ablagerung von leitfähigem Staub auf der Leuchte erwartet werden kann.
- (GB) Use of the luminaire in an environment where a conductive deposition of dust on the luminaire is expected.
- (F) Utilisation du luminaire dans un environnement où un dépôt de poussière conductrice peut être attendu.
- (PL) Zastosowanie oprawy w otoczeniu, w którym można się spodziewać osiadania na oprawie pyłu przewodzącego.
- (E) Uso de la luminaria en un entorno en el que pueda producirse una acumulación de polvo conductor sobre la misma.
- (I) Applicazione della lampada in un ambiente in cui è prevedibile il deposito di polvere conduttiva sull'apparecchio.
-
-
-

- (D) Mindestens Basisisolierung zwischen Strom und Steuerung (DALI) wird vorausgesetzt. Sorgen Sie immer für eine zusätzliche Isolierung zwischen der Niederspannungsversorgung und den Steuerleitern.
- (GB) Minimum basic insulation between power and control (DALI) provided. Always maintain supplementary insulation between low voltage supply and control conductors.
- (F) Isolation minimale de base entre l'alimentation et le contrôle (DALI) fournie. Maintenez toujours une isolation supplémentaire entre l'alimentation basse tension et les conducteurs de commande.
- (PL) Zapewniona minimalna podstawowa izolacja między zasilaniem a sterowaniem (DALI). Zawsze należy utrzymywać dodatkową izolację między przewodami zasilania niskiego napięcia a przewodami sterującymi.
- (E) Aislamiento básico mínimo entre potencia y control (DALI) proporcionado. Siempre mantenga aislamiento suplementario entre el suministro de bajo voltaje y los conductores de control.
- (I) Isolamento minimo di base tra alimentazione e controllo (DALI). Mantenere sempre un isolamento supplementare tra i conduttori di alimentazione e di comando a bassa tensione.

- Ⓓ Die Lichtquelle dieser Leuchte darf nur vom Hersteller oder einem von ihm beauftragten Servicetechniker oder einer vergleichbar qualifizierten Person ersetzt werden.
- ⒼⒹ Only the manufacturer, a trained service technician or another equally qualified person is permitted to replace the light source of this luminaire.
- Ⓕ La source lumineuse de ce luminaire ne peut être remplacée que par le fabricant, un technicien de service mandaté par celui-ci ou une personne présentant une qualification analogue.
- Ⓗ Wymiany źródła światła w tej oprawie oświetleniowej może dokonać wyłącznie producent bądź uprawniony pracownik serwisu albo osoba o podobnych kwalifikacjach.
- Ⓔ La fuente de luz de esta luminaria solamente podrá ser sustituida por el fabricante o una persona designada por este, ya sea un técnico de servicio u otra persona debidamente cualificada.
- Ⓘ La sorgente luminosa di tale lampada può essere sostituita solo dal produttore o da un tecnico di assistenza da questi designato oppure da personale dotato di qualifica equivalente.

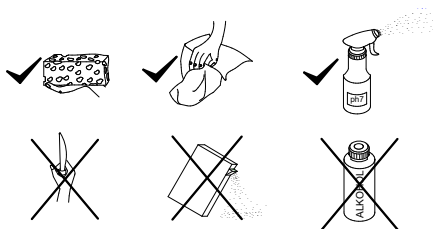
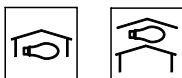
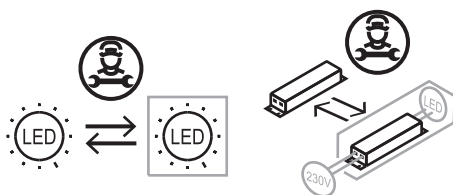

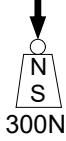

1

RL-DB

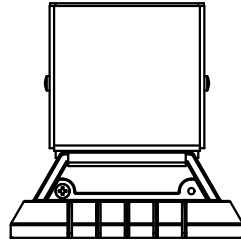

RL-SPO
UKNS



min. 20mm

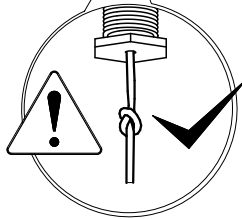
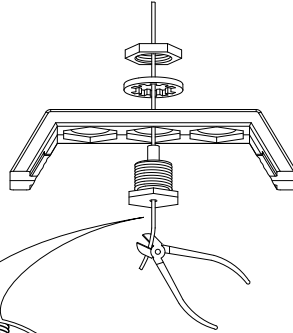
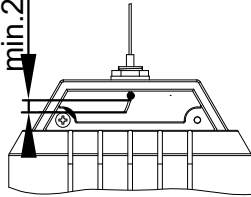

ZRP...

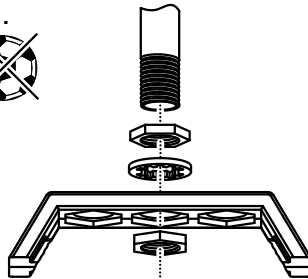
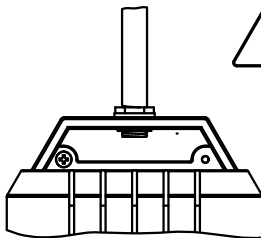

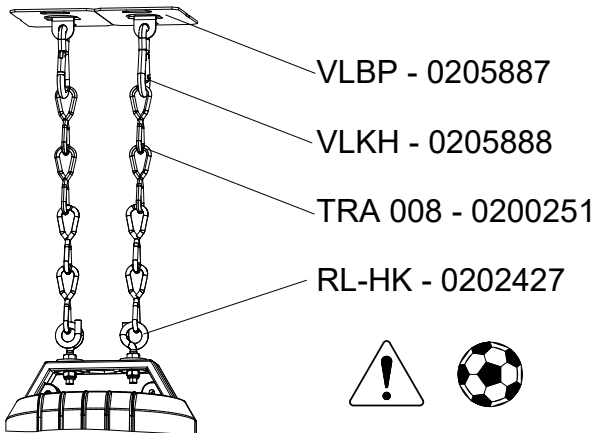
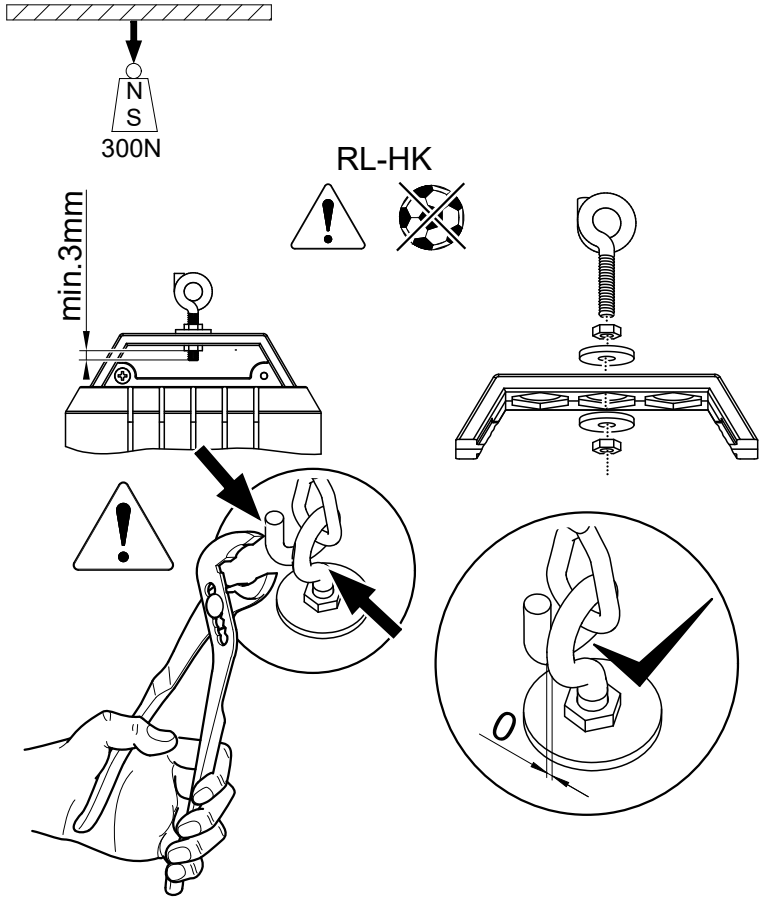

ND



??V / ??Hz



RIDI
.....V
.....Hz

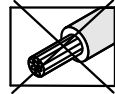
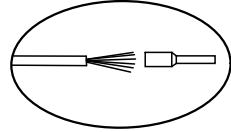
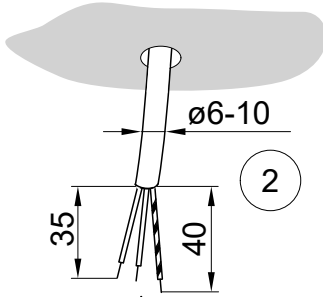

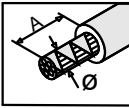
	\varnothing	A
	0,75-1,5	13+1

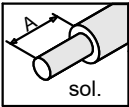
	mm ²	A
sol.	0,75-2,5	14.5+1

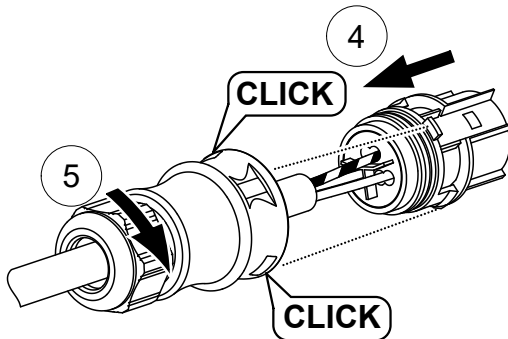
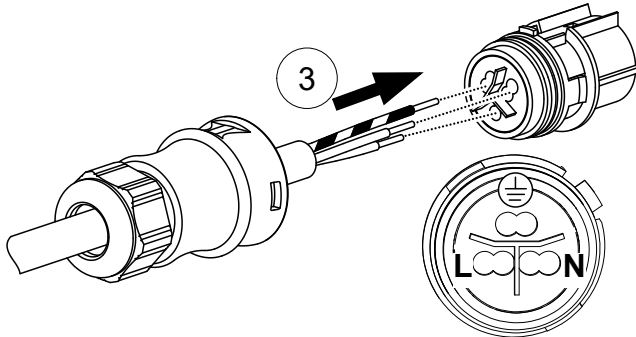

DALI

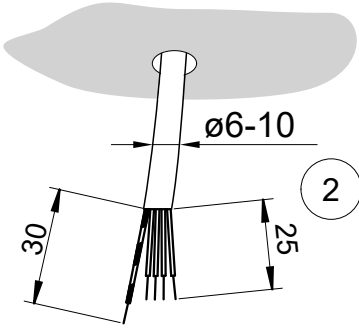

	\varnothing	A
	0,75-2,5	8
	mm ²	A
sol.	0,75-2,5	8

??V / ??Hz



RIDI
 V
 Hz

