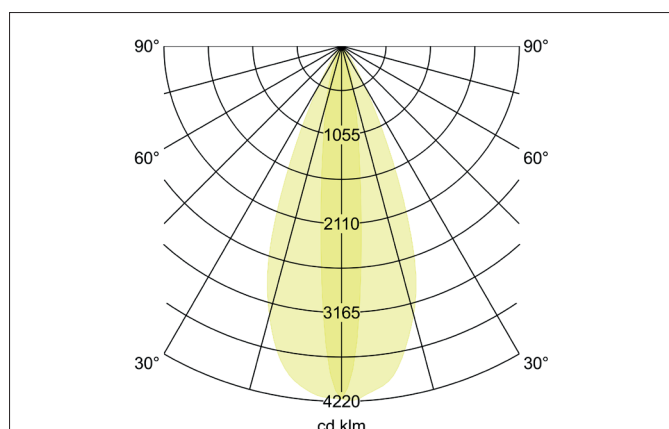
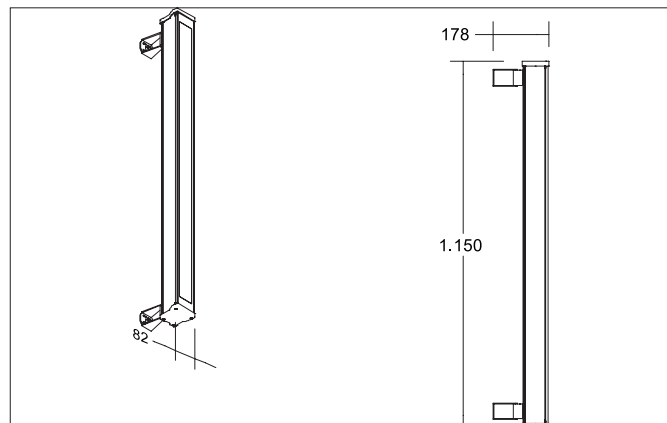

LAVILO I LED Wallwasher, IP66

Article no. 60861644

Light.
For Generations.**Tender**

LED Wallwasher, IP66, Rectangular. Luminaire length 1150.0 mm, Luminaire width 82.0 mm, Hight 86.0 mm Weight 4.8 kg, asymmetric optimal light distribution due to a glass transparent cover. Luminous flux 5.510 lm, Power 44 W, Light colour neutral white, Correlated color temperature (CCT) 4.000 K, Colour rendering index CRI > 80, Housing material: Aluminium / Glass, Colour: Titanium, Permissible ambient temperature (ta): -25 to +50°, Protection class (EN 61140): I, Degree of protection (DIN EN 60529): IP66, shock resistance according to IEC62262: IK08. With electronic driver, DALI dimmable.

Article data	
Article no.	60861644
GTIN	4251433993643
Series name	LAVILO I
Short description	LED Wallwasher, IP66
Material	Aluminium / Glass
Colour	Titanium
Type of surface	Matt
Shape	Rectangular
Length	1,150 mm
Width	82 mm
Hight	86 mm
Scope of delivery	incl. converter for connection to 230 V mains voltage, DALI.
Weight	4.800 kg

LAVILO I LED Wallwasher, IP66

Article no. 60861644

Light.
For Generations.

Lighting technology	
Colour temperature	4.000 K
Light colour	RGBW
Light output	Direct
Luminous flux	5,510 lm
System efficiency	125 lm/W
McAdam-Step	McAdam-Step 5
Colour rendering	CRI > 80
Luminaire optics	Lens
Beam angle	10°
Beam angle 2 asymmetrical	40°
Light sharing	Asymmetric

Operating technology of the luminaire	
System output	44 W
Voltage type	AC
AC nominal voltage max	230 V
Frequenz max.	50 Hz
Frequenz min.	50 Hz
Lamp	LED
Lamp holder	Without fitting
Protection class	I
Degree of protection	IP66
Ambient temperature	-25 bis +50°
Control	DALI
Bulb change possible	The light source of this luminaire may only be replaced by the manufacturer or a service technician commissioned by him or a similarly qualified person.
Rated life time L90/B10 at 25 °C	50.000 h

Mounting technology	
Mounting method	Surface mounting
Place of installation	Wall-mounted
Adjustability	Pivoted
Impact resistance	IK08
stamp	UKCA
Material cover	Glass transparent
Suitable for through-wiring	No

Packing data	
Gross weight	5.3 kg
Length of packaging	1,200 mm
Packaging width	140 mm
Packaging height	140 mm
Disposal at end of life	This product must not be disposed of with household waste. You are obliged, to dispose of such electrical waste separately. By disposing of electrical waste and other old or defective electronics separately, you support recycling or other forms of re-use. In that way you help to take care and to avoid that harmful substances get into the environment.