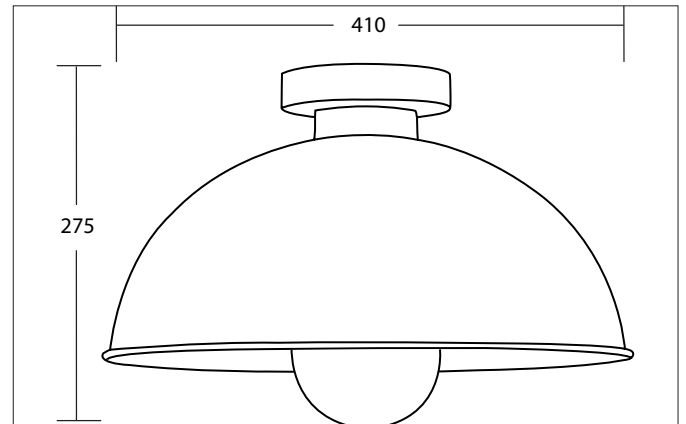

PIERIS Ceiling surface mounted luminaire, for E27 LED retrofit lamp

Article no. 57230850

Light.
For Generations.**Tender**

Ceiling surface mounted luminaire, for E27 LED retrofit lamp, black structure / gold structure, Round.Surface mounting, Ceiling-mounted-Lamp holder: E27, Mounting method: Surface mounting, Place of installation: Ceiling-mounted, Material: Steel, Degree of protection: according to DIN EN 60529 IP20, Protection class: (EN 61140) I, Voltage: 230V AC 50Hz, Power: 15 W, Amount of light sources / fittings: 1 Qty, Adjustability: Not adjustable, without control gear, Control: Other.

Article data

Article no.	57230850
GTIN	4255752510017
Series name	PIERIS
Short description	Ceiling surface mounted luminaire, for E27 LED retrofit lamp
Material	Steel
Type of surface	Structure
Shape	Round
Outer diameter	410 mm
Height	275 mm
Weight	1.730 kg
Conformance	CE, UKCA

Lighting technology

Light output	Direct
Light sharing	Symmetric
Adjustable color temperature	No

PIERIS Ceiling surface mounted luminaire, for E27 LED retrofit lamp

Article no. 57230850

Light.
For Generations.

Operating technology of the luminaire	
Voltage type	AC
AC nominal voltage max	230 V
Frequency max	50 Hz
Lamp	For LED-retrofill lamp
Lamp holder	E27
Protection class	I
Degree of protection	IP20
Control	Other
Bulb change possible	Yes

Mounting technology	
Mounting method	Surface mounting
Place of installation	Ceiling-mounted
Adjustability	Not adjustable
Material cover	Without cover
Suitable for through-wiring	No

Packing data	
Gross weight	2.82 kg
Length of packaging	460 mm
Packaging width	460 mm
Packaging height	265 mm
Disposal at end of life	This product must not be disposed of with household waste. You are obliged, to dispose of such electrical waste separately. By disposing of electrical waste and other old or defective electronics separately, you support recycling or other forms of re-use. In that way you help to take care and to avoid that harmful substances get into the environment.