

DACTYL Ceiling surface mounted luminaire, for E14 LED retrofit lamp, with wooden housing and metal shades

Article no. 57113180

Light.
For Generations.

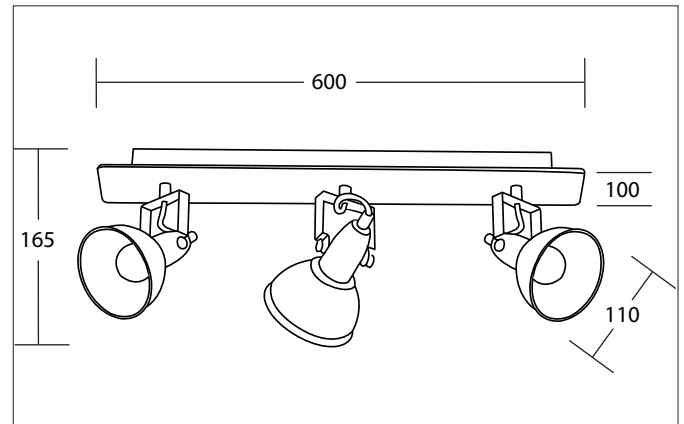

Tender

Ceiling surface mounted luminaire, for E14 LED retrofit lamp, with wooden housing and metal shades, textured black / light wood, Other. Surface mounting, Ceiling-mounted Lamp holder: E14, Mounting method: Surface mounting, Place of installation: Ceiling-mounted, Material: Wood / Steel, Degree of protection: according to DIN EN 60529 IP20, Protection class: (EN 61140) I, Voltage: 230V AC 50Hz, Power: 10 W, Amount of light sources / fittings: 3 Qty, Adjustability: Rotable and pivoted, without control gear, Control: Other.

Article data	
Article no.	57113180
GTIN	4251433994763
Series name	DACTYL
Short description	Ceiling surface mounted luminaire, for E14 LED retrofit lamp, with wooden housing and metal shades
Material	Wood / Steel
Type of surface	Structure
Shape	Other
Length	600 mm
Width	140 mm
Height	165 mm
Weight	1.242 kg
Conformance	CE, UKCA

Lighting technology	
Light output	Direct
Light sharing	Symmetric
Adjustable color temperature	No

DACTYL Ceiling surface mounted luminaire, for E14 LED retrofit lamp, with wooden housing and metal shades

Article no. 57113180

Light.
For Generations.

Operating technology of the luminaire	
Voltage type	AC
AC nominal voltage max	230 V
Frequency max	50 Hz
Lamp	For LED-retrofill lamp
Lamp holder	E14
Protection class	I
Degree of protection	IP20
Control	Other
Bulb change possible	Yes

Mounting technology	
Mounting method	Surface mounting
Place of installation	Ceiling-mounted
Adjustability	Rotable and pivoted
Swivel angle	40°
Rotation angle	355°
Material cover	Without cover
Suitable for through-wiring	No

Packing data	
Gross weight	1.538 kg
Length of packaging	620 mm
Packaging width	180 mm
Packaging height	130 mm
Disposal at end of life	This product must not be disposed of with household waste. You are obliged, to dispose of such electrical waste separately. By disposing of electrical waste and other old or defective electronics separately, you support recycling or other forms of re-use. In that way you help to take care and to avoid that harmful substances get into the environment.