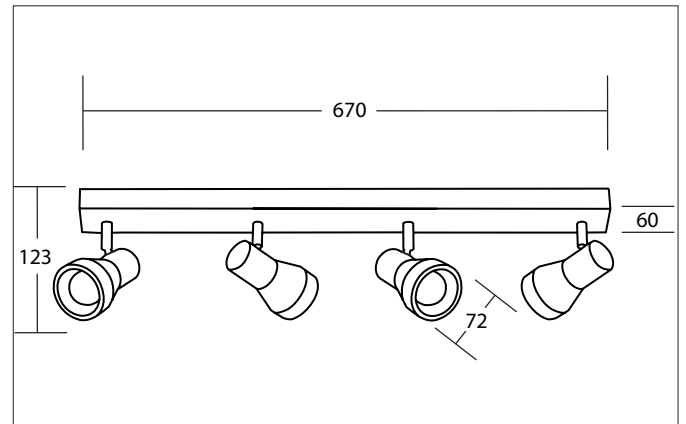

**BOLORIA Ceiling surface mounted luminaire, for E14 LED retrofit lamp, with wooden housing and concrete shades**

Article no. 57174730

Light.  
For Generations.**Tender**

Ceiling surface mounted luminaire, for E14 LED retrofit lamp, with wooden housing and concrete shades, light wood / matt concrete, Rectangular. Surface mounting, Ceiling-mounted Lamp holder: E14, Mounting method: Surface mounting, Place of installation: Ceiling-mounted, Material: Wood / Concrete, Degree of protection: according to DIN EN 60529 IP20, Protection class: (EN 61140) I, Voltage: 230V AC 50Hz, Power: 5 W, Amount of light sources / fittings: 4 Qty, Adjustability: Rotable and pivoted, without control gear, Control: Other.

Article data	
Article no.	57174730
GTIN	4255752510239
Series name	BOLORIA
Short description	Ceiling surface mounted luminaire, for E14 LED retrofit lamp, with wooden housing and concrete shades
Material	Wood / Concrete
Type of surface	Matt
Shape	Rectangular
Length	770 mm
Width	72 mm
Height	123 mm
Weight	1.412 kg
Conformance	CE, UKCA

Lighting technology	
Light output	Direct
Light sharing	Symmetric
Adjustable color temperature	No

**BOLORIA Ceiling surface mounted luminaire, for E14 LED retrofit lamp, with wooden housing and concrete shades**

Article no. 57174730

Light.  
For Generations.

Operating technology of the luminaire	
Voltage type	AC
AC nominal voltage max	230 V
Frequency max	50 Hz
Lamp	For LED-retrofill lamp
Lamp holder	E14
Protection class	I
Degree of protection	IP20
Control	Other
Bulb change possible	Yes

Mounting technology	
Mounting method	Surface mounting
Place of installation	Ceiling-mounted
Adjustability	Rotable and pivoted
Swivel angle	40°
Rotation angle	355°
Material cover	Without cover
Suitable for through-wiring	No

Packing data	
Gross weight	1.974 kg
Length of packaging	150 mm
Packaging width	140 mm
Packaging height	720 mm
Disposal at end of life	This product must not be disposed of with household waste. You are obliged, to dispose of such electrical waste separately. By disposing of electrical waste and other old or defective electronics separately, you support recycling or other forms of re-use. In that way you help to take care and to avoid that harmful substances get into the environment.