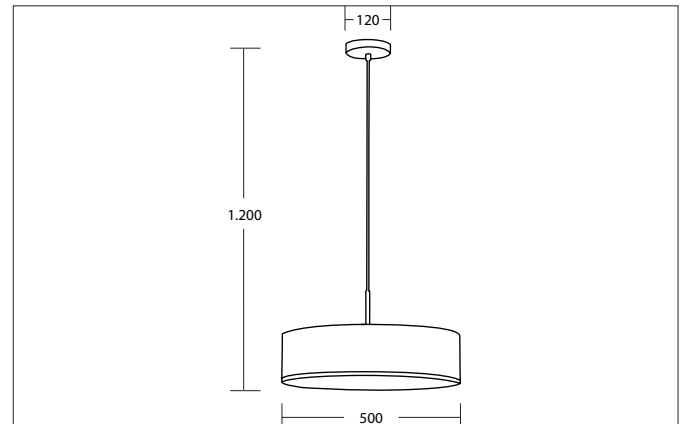

TIM Pendant luminaire, for E27 LED retrofit lamps, with fabric shade 500 mm

Article no. 57196470

Light.
For Generations.**Tender**

Pendant luminaire, for E27 LED retrofit lamps, with fabric shade 500 mm, matt nickel / cream shade, Round.Suspended, Ceiling-mounted-Lamp holder: E27, Mounting method: Suspended, Place of installation: Ceiling-mounted, Material: Steel / Fabric, Degree of protection: according to DIN EN 60529 IP20, Protection class: (EN 61140) I, Voltage: 230V AC 50Hz, Power: 15 W, Amount of light sources / fittings: 3 Qty, Adjustability: Not adjustable, without control gear, Control: Other.

Article data	
Article no.	57196470
GTIN	4255752509936
Series name	TIM
Short description	Pendant luminaire, for E27 LED retrofit lamps, with fabric shade 500 mm
Material	Steel / Fabric
Type of surface	Matt
Shape	Round
Outer diameter	500 mm
Hight	1500 mm
Shade colour	cream
Shade material	Fabric
Scope of delivery	mit Pendelabhängung 1.200 mm
Weight	1.460 kg
Conformance	CE, UKCA

TIM Pendant luminaire, for E27 LED retrofit lamps, with fabric shade 500 mm

Article no. 57196470

Light.
For Generations.

Lighting technology	
Light output	Direct
Light sharing	Symmetric
Adjustable color temperature	No

Operating technology of the luminaire	
Voltage type	AC
AC nominal voltage max	230 V
Frequency max	50 Hz
Lamp	For LED-retrofill lamp
Lamp holder	E27
Protection class	I
Degree of protection	IP20
Control	Other
Bulb change possible	Yes

Mounting technology	
Mounting method	Suspended
Place of installation	Ceiling-mounted
Adjustability	Not adjustable
Pendulum length max.	1,200 mm
Material cover	Fabric
Suitable for through-wiring	No

Packing data	
Gross weight	2.6 kg
Length of packaging	510 mm
Packaging width	520 mm
Packaging height	160 mm
Disposal at end of life	This product must not be disposed of with household waste. You are obliged, to dispose of such electrical waste separately. By disposing of electrical waste and other old or defective electronics separately, you support recycling or other forms of re-use. In that way you help to take care and to avoid that harmful substances get into the environment.