

GUIDE

TECHNICAL

CABLE TRAYS

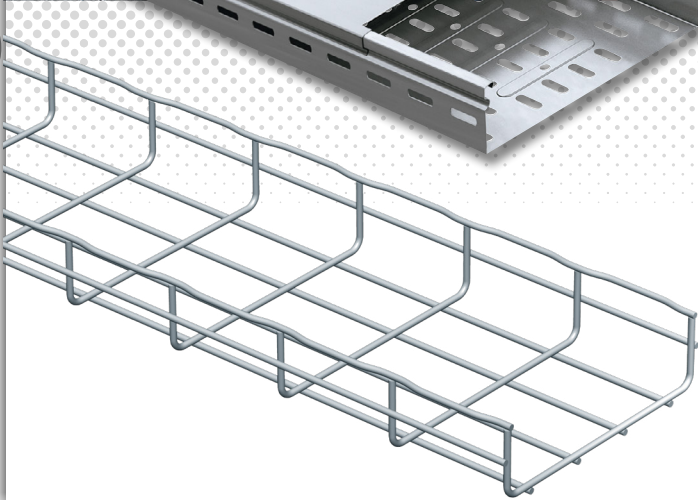

THE GLOBAL SPECIALIST IN ELECTRICAL AND DIGITAL BUILDING INFRASTRUCTURES

 **legrand**[®]



LEGAL INFORMATION

Presentation pictures do not always include Personal Protective Equipment (PPE), but this is a legal and regulatory obligation that must be scrupulously respected.

In accordance with its continuous improvement policy, Legrand reserves the right to change the specifications and illustrations without notice. All illustrations, descriptions and technical information included in this document are provided as indications and cannot be held against Legrand.



Not all cable trays are equivalent. The mechanical and electrical characteristics, tests, certifications, overall quality management, recommendations mentioned in this technical guide only apply to our own cable management ranges and cannot under any circumstances be transposed to similar or imitation products.

CONTENTS

Safety instructions	2
Standards information	4
Materials and surface treatments	8
Safe working load	20
Earthing	24
Electrical continuity	26
Short-circuit	27
Electromagnetic performance	28
Fire resistance	30
Power cables	32
Data current	34
Fibre optic data cables	36
Copper data cables	38



SAFETY

INSTRUCTIONS

General information about electricity

- Use only the products and accessories recommended by the Legrand Group in the catalogue, instructions, technical data sheets and all other documents provided by Legrand (hereinafter referred to as «the Documentation») in compliance with the installation rules.
- Improper installation and/or use may result in the risk of arcing in the enclosure, overheating or fire. The enclosures must be used under normal conditions, they must not be subjected to Voltage / Current / Temperature values other than those specified in the Documentation.
- Legrand declines all responsibility for any modification or repair of the equipment making up the enclosure that is not authorized by the Legrand Group, as well as any failure to comply with the rules and recommendations specified by Legrand in the Documentation. In addition, in the cases mentioned above, the warranty granted by Legrand will not be applicable.
- It is necessary to check that the characteristics of the products are appropriate for their environment and use during maintenance operations, and to refer to the Documentation. If you have any questions or require clarification, please contact Legrand Group.
- The installation, use and maintenance of electrical enclosures and their components must be carried out by qualified, trained and authorized personnel, in accordance with the regulations in force in each country.



RISK OF ELECTRIC SHOCK, BURNS AND EXPLOSION.

- People working on electrical installation must have the appropriate electrical authorizations for the work to be carried out.
- Wear the PPE (Personal Protective Equipment) necessary to work on live products.
- Respect the safety rules related to electrical work.
- Improper electrical and mechanical use of equipment can be dangerous and may result in personal injury or damage to property.
- Depending on the maintenance operations to be carried out, partial or total power cuts of the enclosure concerned should be planned before any work.
- When performing operations that involve access to the inside of the enclosure, be aware of the risk of burns before touching any products or metal parts.
- Before turning the power back on, make sure that there are no foreign bodies and that all physical protections have been put back in place (e.g.: screens, covers, shields).

Any failure to strictly apply the procedures and to respect these recommendations, could lead to serious risk of accident, endangering people and property (in particular, without limitation, risk of burns, electric shocks, etc.).



! The rules and recommendations in this document are based on our knowledge of the typical conditions of use of our products in the fields of application usually encountered. However, it is always the customer's responsibility to verify and validate that Legrand products are suitable for its installation and use.

The customer must ensure proper installation, maintenance and operation of the equipment to avoid any risk of injury to personnel or damage to property in the event of product failure, especially for applications that require a very high level of safety (e.g., those in which the failure of a component may endanger human life or health).

The rules for storage, handling, installation and maintenance and the appropriate precautions and warnings must be strictly observed and applied.

STANDARDS INFORMATION

The manufacture and use of cable trays are subject to specific strict regulations which change over time. In this section, we provide an update of current texts which define product compliance.

Marking, compliance, certificates, declarations: what you need to know

CE MARKING

In the context of the single European market, European directives ensure free movement and compliance with minimum safety standards. Each product type then has its own reference European directives. These are transposed into national law in each country. CE marking is proof, self-declared by the supplier, of compliance with all the European directives applicable to the product.

All products circulating in the European territory must be marked with the CE logo. They are subject to the supervision of the competent authorities who have the authority to ask manufacturers to produce their CE certification reports or take samples.

NATIONAL MARKS OF CONFORMITY (NF, IMQ, GOST, ANCE, UL, ETC)

These guarantee that the relevant products comply with national standards or those commonly applied in the country (NF in France, IMQ in Italy, NEMA in USA, etc). This compliance is certified by third parties (LCIE for NF standards, UL for UL standards, IMQ for IMQ standards, etc) who conduct audits several times a year. Some national standards may give rise to corresponding international marks.



Manufacturer declaration of conformity

The Legrand group product testing laboratories are recognised and approved by the national certification bodies (LCIE, IMQ, etc) which make regular checks so the official standard tests can be conducted. The results of these tests are communicated in the form of the declaration of conformity.

This technical documentation discusses topics such as the level of resistance to corrosion, safe working loads or electrical continuity, and is available on request.



Example of declaration of conformity

Environmental directives and regulations

ENVIRONMENTAL IMPACT

• PEP - Product Environmental Profile

The PEP is a reference tool providing information about the environmental impacts of electrical products. It is based on the international reference standard, ISO 14025 "Environmental labels and declarations. Type III environmental declarations". The information provided results from the life cycle analysis approach which is used to assess scientifically the environmental impacts assessed according to a number of indicators (ISO 14040 "Environmental Management - LCA), from the design stage to recycling, including manufacture and use.

This eco-declaration is neither a label nor a regulatory marking, but the PEP does constitute an essential decision support tool for any company signed up to an environmentally-responsible construction approach.



The PEP sheets for Legrand products are available on request.

TRACEABILITY AND DISPOSAL OF HAZARDOUS SUBSTANCES

• ROHS - Restriction of Hazardous Substances

The RoHS European directive (2002/95/EC) defines the rules concerning restriction of use of hazardous substances applicable to electrical and electronic products. The substances covered include lead, mercury, cadmium, hexavalent chromium, PBB and PBDE.

In addition to the regulatory obligations the RoHS directive imposes in Europe, Legrand has committed to ensuring that all its products sold throughout the world comply with the RoHS directive rules concerning restriction of use of hazardous substances.

• REACH - Registration, Evaluation, Authorisation and Restriction of Chemicals

REACH is a European regulation (no. 1907/2006) [...] which ensures safe manufacturing and use of chemicals in industry throughout Europe. It lists, assesses and monitors chemicals manufactured, imported, or placed on the European market.

A group of experts from the materials laboratory has got together with buyers to identify types of materials and items purchased that are highly likely to contain REACH substances, so we can consult the targeted suppliers as a priority for constructive discussions. They are also in charge of finding, as soon as the lists of candidate substances are published, alternative solutions the R&D teams can be encouraged to use.

CONFLICT MINERALS

As a responsible company, Legrand supports the OECD initiatives by following the information in the "OECD Due Diligence Guidance for Responsible Supply Chains of Minerals from Conflict-Affected and High-Risk Areas" and is gradually putting together an approach to identify and assess the risks associated with its supply chain.

ENVIRONMENTAL AND ENERGY COMMITMENT

• ISO 14001

Legrand has made a deliberate commitment to be certified ISO 14001; the requirements of this standard based on environmental management help contribute to sustainable development, protection of the environment and improvement of site performance. As part of a process of continuous improvement, environmental actions are intended to reduce energy consumption and the amount of waste by expanding sorting systems, and to manage water consumption and emissions into the atmosphere.

Certification can be obtained from Legrand on request.

Quality commitment

• ISO 9001

This standard promotes management of quality risks based on continuous improvement and incorporates the PDCA (Plan-Do-Check-Act) cycle. Through its application, the goal is constant improvement in customer satisfaction by supplying products conforming to the required level of quality.

ISO 9001 certificates are available on request.



Example of ISO 9001 certificate

The various standards

STANDARD IEC 61 537 "INTERNATIONAL ELECTROTECHNICAL CONTRACTORS STANDARD FOR CABLE TRAY SYSTEMS - CABLE LADDER SYSTEMS"

This is the reference for qualification of cable management products. Because of its expertise, Legrand is part of the working group for IEC 61537 edition 3 and is de facto involved in following up claims and development projects. This standard specifies the requirements and test methods for cable trays, cable ladders, supports and their accessories to ensure complete safety of installations. The topics discussed are:

- Mechanical strength
- Electrical continuity
- Electrical conductivity
- Resistance to corrosion
- Fire resistance
- Impact resistance

NEMA VE 1-2017

Specifies requirements for metal cable trays and associated fittings designed for use in accordance with the rules of Canadian Electrical Code, Part I and the National Electrical Code®

STANDARDS AND GUIDES YOU NEED TO KNOW

The following standards define the precautions to be taken when installing and using our products:

- IEC 60364: "Low Voltage Electrical Installations"
- Standard EN 50174-2: "Information technology – Cabling installation"
- Practical guide UTE C 15-900: "Low voltage electrical installations – Erection and coexistence of power and communication networks in residential, tertiary and analog buildings."
- Practical guide UTE C 15-520: "Low voltage electrical installations, wiring systems, methods of installation, connections"
- Practical guide UTE C 15-103: "Low voltage electrical installations. Selection of electrical equipment (including wiring systems) in relation to external influences."

MATERIALS AND SURFACE TREATMENTS

Corrosion

A recurring theme with all metal applications, corrosion can result in poorer performance and affect the installation's life expectancy if not kept in check.

The cable management system is exposed to an outdoor environment which can be of varying harshness and hence a source of corrosion.

1) ENVIRONMENTAL CORROSION

Metal corrosion is a chemical reaction between the iron contained in the steel and dioxygen in the air or water (humidity, water vapour, rain, splashes, acidic substances).

Other aqueous or gaseous additives may contribute to corrosion phenomena.

The result is the appearance of a chemical called red rust (Fe_2O_3).

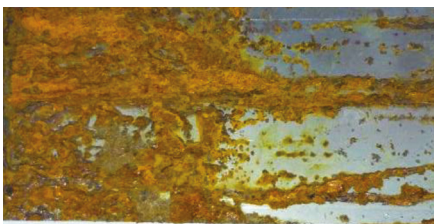

Knowing precisely what environment the cable tray will be installed in allows us to choose the appropriate surface treatment.

(See Corrosion class table on page 16)

2) GALVANIC CORROSION

Galvanic corrosion results from an electrochemical phenomenon due to the potential difference existing between different metals, or between a metal and the impurities it contains when they are electrically connected.

		Metal being paired									
		Metal considered									
		Stainless steel	Nickel	Copper	Brass	Steel	Aluminium	Chromium	Zinc		
304L	316L	0									
		180									
		320	140	0							
		400	220	80	0						
		750	570	430	350	0					
		840	660	520	440	90	0				
		950	770	630	550	200	110	0			
EZ	GS	GC	ZnL	HR							
		1150	970	830	750	400	310	200	0		

Electrolytic compatibility of metals in water with 2% NaCl

A maximum limit of 400 mV is deemed to be acceptable for limiting the corrosion phenomenon between two metals.

Caution: this table must be treated as an aid for selecting solutions, it cannot totally predict actual behaviour, which will also be influenced by numerous other factors: composition of the electrolyte, pH, amount of water, temperature, oxygenation of the environment, surface ratios (see below), etc.

However under certain conditions, metals with a high potential difference can be compatible. Thus, stainless steel can sometimes be used with zinc, when the zinc contact surface area is significantly greater than that of the stainless steel. For example, combining the stainless steel multiclip BFC with pregalvanised products.



Zinc cable tray and stainless steel accessory

Galvanic corrosion must be taken into account within the whole cable management system and makes it essential to choose the right supports, accessories (coupling, screws, equipotential bonding, etc).

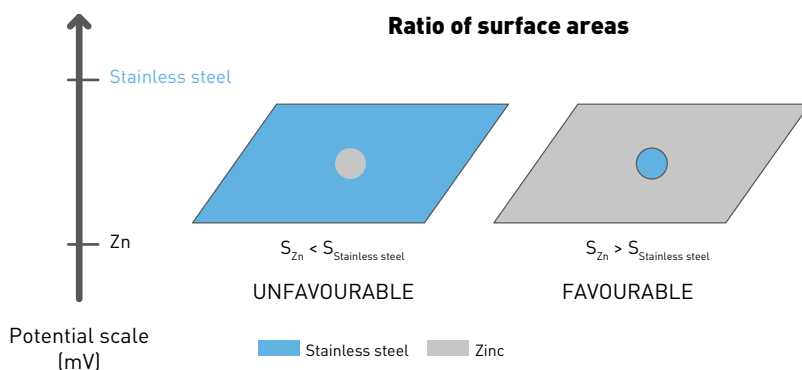

Solutions

1) COATED STEELS

Steel is coated with zinc or zinc-based alloys as protection against corrosion. Galvanic protection of steel is a sacrificial process: as long as there is enough zinc on a piece of steel, the zinc will rust before the steel starts to rust. Once the zinc is completely used up, the steel exposed to the open air will start to rust and form red rust.

Accelerated corrosion resistance tests (salt spray) will create hydrocarbonate and zinc oxide, more commonly called white rust. Apart from in very harsh environments, in reality, zinc will self-passivate and the whitish film which appears corresponds to this temporary passivation, not to white rust.

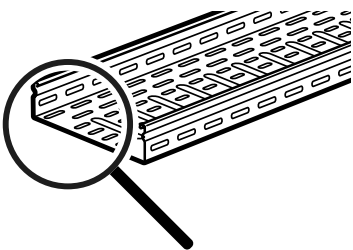

• Initial state:

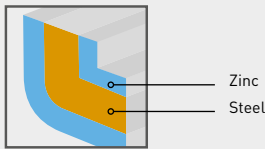

The steel (iron) is protected with a layer of zinc

• Intermediate state:

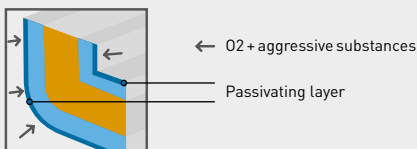

In the open air, zinc self-passivates which leads to a matte appearance, and can create a thin white film on the part.

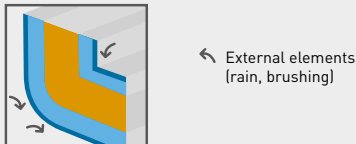

External agents strip off the passivating zinc layer

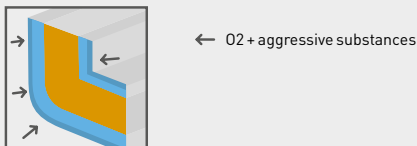

The bare zinc self-passivates again

This cycle continues as long as there is any zinc left

• Final state:



The steel is no longer protected by the zinc. It will then corrode

These are the surface treatments Legrand offers against corrosion; all our solutions comply with the RoHS directive:

a. Pregalvanised/Precoated Steels:

PG/GS : Continuous galvanisation prior to manufacturing using the Sendzimir process

>> PG standard (wire): EN 10244-2 // GS (accessories and sheet metal): EN 10346

Prior to manufacturing, a zinc coating is deposited by continuous immersion on the sheet metal or steel wires. The appearance of parts is then smooth and grey and protected against corrosion.

ZnAl : Zinc Aluminium prior to continuous manufacturing using the Sendzimir process

>> Standard EN 10244-2

Products are manufactured with steel that has been pregalvanised by continuous immersion in zinc alloy containing aluminium. It has a matte appearance. It is a good alternative to GC for environments in marine conditions with a high ammonia content, but not in sulphurous environments.

• Specific features of Zinc Aluminium:

The Zinc Aluminium coating has the property of self-generating a protective layer on the wires. These are covered with aluminium hydroxyde and aluminium oxide which create a white film that provides extra resistance to corrosion.

In addition, the Zinc Aluminium coating has the advantage of a "healing" effect of the cuts made according to Legrand's instructions. The effect is more or less rapid (in the months following installation) depending on the conditions of exposure of the products. The protective layer completely or partially covers the section, up to about 2 mm towards the center of the wire. Large wire diameters can thus

show a very little visible residual spot of red rust in the center of the wire, but without any risk of propagation in depth, in the heart of the wire.

By design, thanks to the safety edge, Cablofil cable trays do not have protruding wire ends, which reduces the risk of corrosion. Only the ends of the cable trays leave visible the sectioned wires.

ZnMg : Zinc Magnesium prior to continuous manufacturing using the Sendzimir process

>> Standard EN 10346

Products are manufactured with steel that has been pregalvanised by continuous immersion in a zinc alloy containing magnesium and aluminium. It is darker than GS. It is a good alternative to GC for environments in marine conditions with a high ammonia content, but not in sulphurous environments.

• Specific features of Zinc Magnesium:

The Zinc Magnesium coating has the property of self-generating a protective layer on the sections. These are covered with magnesium hydroxychloride which creates a white film that provides extra resistance to corrosion.

The Zinc Magnesium coating has the advantage of a "healing" effect on cuts made according to Legrand's instructions. The effect is more or less rapid (in the months following installation) depending on the conditions of exposure of the products. The protective layer completely or partially covers the section up to about 2 mm towards its center. Large metal sheet thicknesses can thus show a very little visible residual spot of red rust in the center of the section, but without any risk of spreading to the heart of the sheet..

b. Steels Post-treated with wet processing

EZ : Electrogalvanising with zinc-based electrolytic deposit

>> Standard ISO 2081

Cable trays or accessories are made from raw steel, and are then pickled and plunged into an electrolyte containing zinc. The passage of an electric current creates the zinc deposit. This coating can be chosen as much for its performance as for its aesthetics. The passivation provides a smooth, bluish-grey shiny appearance which delays the appearance of white rust.

EZ+ : Black electrogalvanising after manufacturing + organic layer

>> Standard ISO 2081

Following the electrogalvanising process, an organic top coat is added in the aqueous phase. This last step gives a black and matte appearance to the product.

ZnNi : Zinc Nickel zinc and nickel based electrolytic deposit

>> Standard ISO 15726

Cable trays or accessories are made from raw steel, and are then pickled and plunged into an electrolyte containing mainly zinc and nickel. This composition can provide better resistance to corrosion than with EZ, ZnL or even GC in certain conditions (see table of classes). ZnNi has a greyer, more matte appearance than EZ.

ZnNi+ : Zinc Nickel zinc and nickel-based black electrolytic deposit

>> Standard ISO 15726

This is the same electrolytic process as the previous ZnNi with the addition of black colour to the top coat.

The performance of the electro-zinc coating must not only be judged on the final thickness (zinc + passivation) but primarily on the choice of passivation.



Solutions (continued)

c. Steels Post-treated with hot dip galvanisation

GC : Hot dip galvanised after manufacturing
 >> [Standard EN ISO 1461](#)

Cable trays or accessories are made from raw steel, and are then degreased, pickled and plunged into a bath of molten zinc. The coating obtained is a increasing combination of successive inter-metallic layers of zinc/iron, which is very rich in zinc on the surface. This process must be chosen for its performance above all rather than for its aesthetics (grey, somewhat rough, with a bloom, matte). On delivery of the products, a thin white film (zinc hydroxyde) may be noticed which does not affect the resistance to corrosion.

d. Steels Post-treated with aqueous dispersion

ZnL : Zinc rich coating
 >> [Standard EN 13858](#)

(Cable trays and accessories) // ISO 10683 (fixing elements)

Zinc rich coating is a treatment based on superimposing zinc and aluminium flakes in an organic matrix. It has equivalent protection to GC in certain conditions (see table of classes) and is mainly used on small accessories (fixing elements, screws, etc).

2) STAINLESS STEEL

Particularly harsh environments mean that it is not the coating that needs to be considered but the actual type of steel. Legrand has chosen two main austenitic stainless steels, 304L and 316L, for their high resistance to corrosion, obtained

partly due to their high chromium content. We also use austenitic stainless steel 301 and 302 for specific assemblies which require a spring effect with guaranteed high mechanical withstand.

304L >> [Standard EN 10088-2 and EN 10088-3 - Composition: X2CrNi18-9](#)

This is an austenitic grade containing chromium (17.5 to 19.5 %) and nickel (8 to 10.5 %). It has good resistance to corrosion in fresh water, natural atmospheres, in food processing environments (except products rich in salt, pectin, soy sauce, halogens, bases, mustard and white wine) both indoors and outdoors.

316L >> [Standard EN 10088-2 and EN 10088-3 - Composition: X2CrNiMo17-12-2](#)

This is an austenitic grade containing chromium (16.5 to 18.5 %), nickel (10 to 13 %) and molybdenum (2 to 2.5 %), therefore offering significantly improved resistance to corrosion and better suited to corrosive environments.

NB: 304L - 316L, L = low carbon, improves resistance to corrosion and limits formation of carbides during welding processes.

301 >> [Standard EN 10088-2 - Composition: X10CrNi18-8](#)

It has resistance to corrosion similar to that of 304L. It can be used to obtain spring steel with better mechanical characteristics than 304L and 316L.

302 >> [Standard EN 10270-3 - Composition: X10CrNi18-8](#)

This has the same characteristics as 301 but 302 is used specifically for wire products.



Untreated

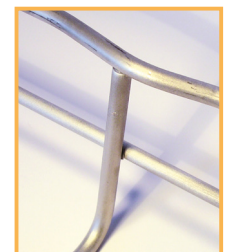

Pickled and passivated



Untreated



Pickled and passivated

IMPROVEMENT IN PERCEIVED AESTHETICS AND LIFE OF STAINLESS STEEL

• Pickling and passivation

All welded or potentially contaminated stainless steel products undergo a pickling/passivation treatment. These two steps are fundamental to the product's life and the installation's longevity.

Pickling and our special passivation give stainless steel a light grey matte appearance.

• **Protective film**

One solution to protect stainless steel against pollution is to wrap products in film from manufacture until delivery.

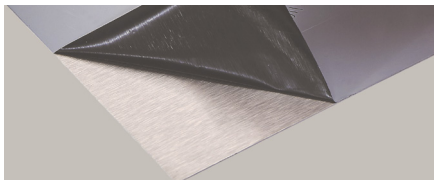

STAINLESS STEEL AND MAGNETISM

The main source of magnetism in the case of stainless steels (304L, 316L, 301, 302, etc) is the degree of hardening when it is cold worked, and causes a magnetic metallurgical phase at high dose. Hardening on the sheet or wire is a phase in the metal hardening industrial process during its plastic deformation.

In order to maintain the quality of the stainless steel, the following chart illustrates the importance of rinsing stainless steel products when they have just been contact with acids or chlorides.

Stainless steel and rinsing chlorides and acids:

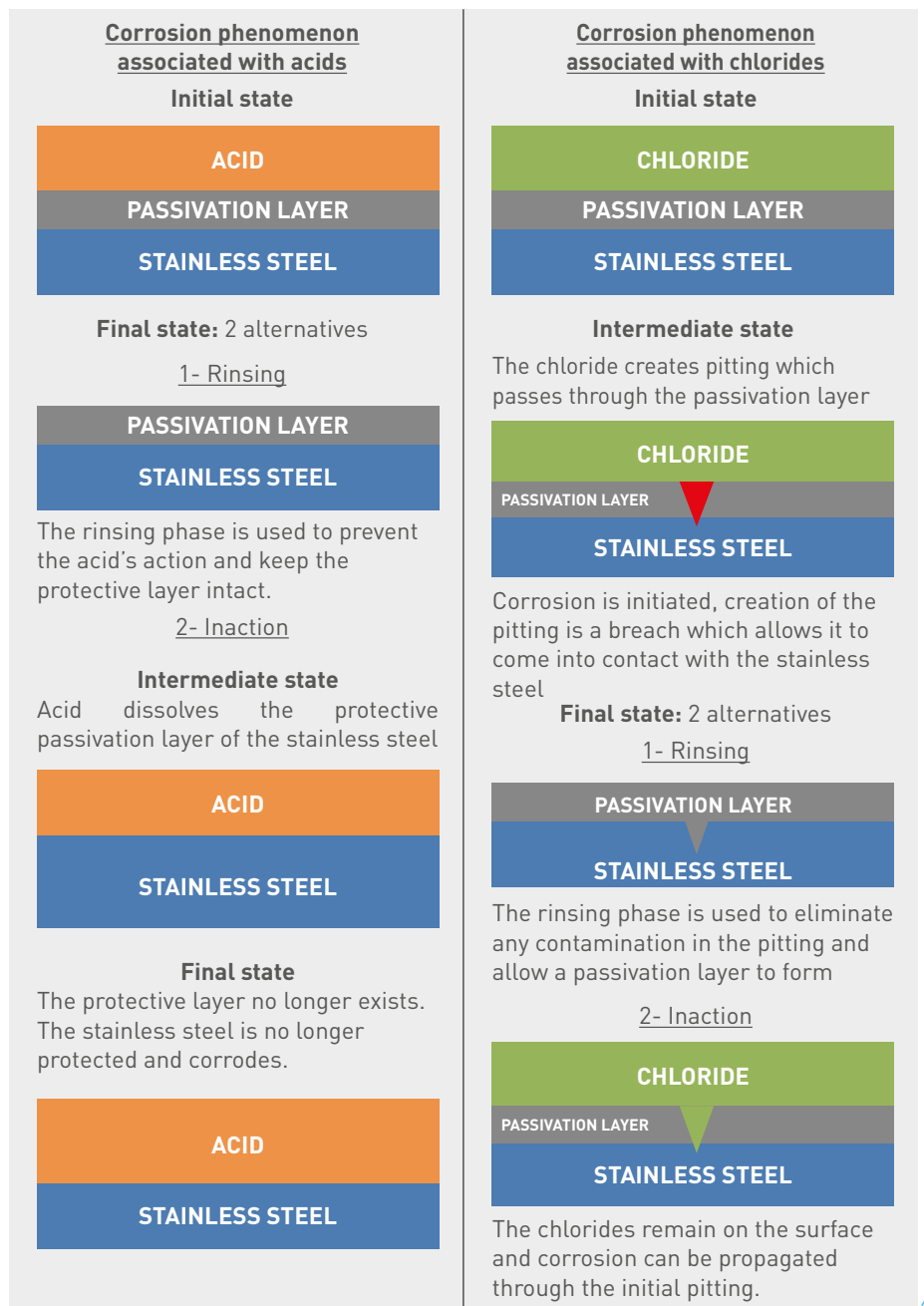

Solutions (continued)

3) CUTTING/DAMAGING THE PROTECTIVE LAYER ON PRODUCTS

When fitting cable trays and their accessories, the products are cut on site to create changes of direction, adjust sections, etc. Damage can also occur during handling; as a result, both the protective layer against corrosion and the appearance may be damaged.

However, in certain cutting conditions (depending on the tool used and the thickness of metal being cut), metal products benefit from cathodic protection (zinc migration) obtained by a smeared off effect. This chemical reaction can then be complemented by applying zinc with an aerosol.

Cutting stainless steel

To limit the amount of contamination on products made of stainless steel which would cause corrosion breaking lines, it is advisable to use spotlessly clean cutting tools.

	<p>Bolt cutters</p>	<p>Used exclusively for cutting wires, these have a strong smeared off effect. Depending on which wires are cut, a certain cutting angle should be used to minimise sharp edges.</p>	
	<p>Jigsaw</p>	<p>Fast but causes vibrations in the cable tray, this causes a few steel strands to appear and benefits from a good smeared off effect.</p>	
	<p>Grinder</p>	<p>Fast, this splits sections at very high temperature as it passes through, leaving black burn marks and very rough patches in the form of steel chips which often need to be filed down. To be handled with precision, cutting with a grinder causes vibrations in the cable tray. It should be noted that this tool can require a hot-work permit.</p>	
	<p>Notching machine</p>	<p>Effective for cutting the back of cable trays. It is more difficult to use in the racks and may cause local deformation. This can lead to problems when fitting the couplers.</p>	
	<p>Shears</p>	<p>Not suitable for cutting cable trays with complex geometries. The cutting action is actually more like tearing the material and removes all or part of the zinc protection.</p>	

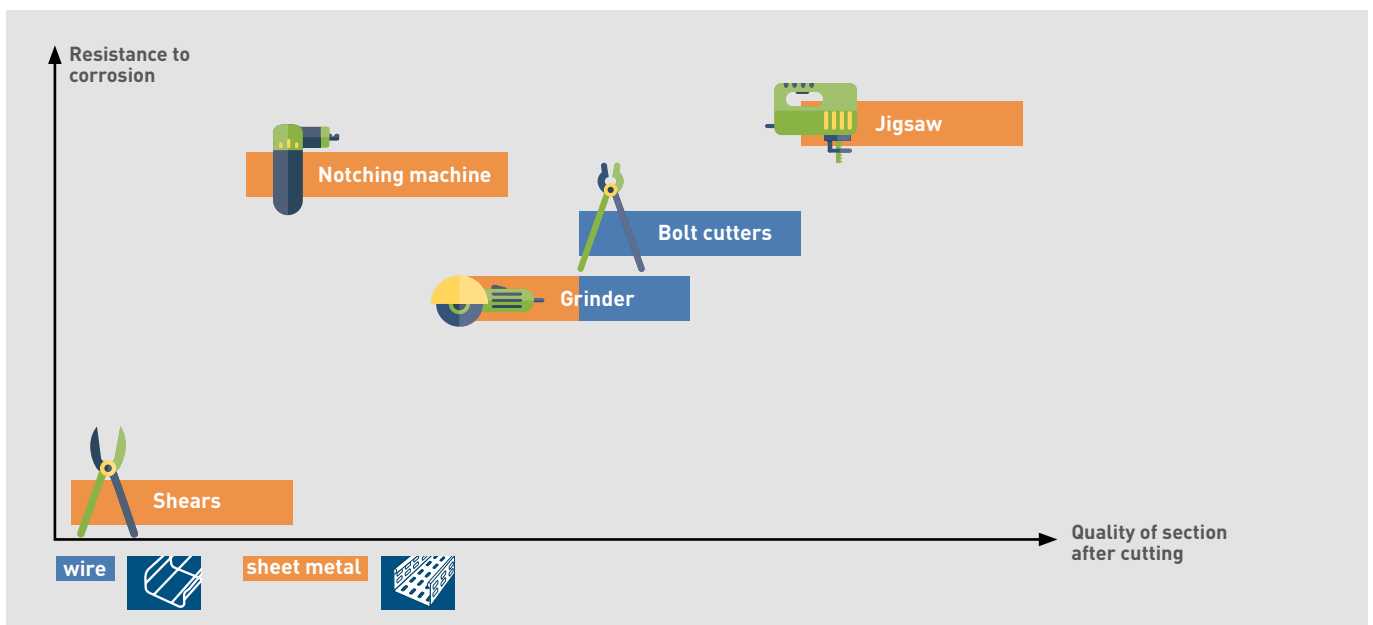

4) ACCELERATED CORROSION RESISTANCE TESTS

The salt spray test (neutral salt spray) according to standard ISO 9227 is the most widely-used test and is recognised for cable trays – reference IEC 61537. However, it is not automatically the most typical of corrosive environments we encounter, nor does it take account of how certain surface treatments actually behave. This is why we conduct additional tests so as to ensure that the surface treatment corresponds as well as possible to the environment in which the product will be used.

5) CORROSION RESISTANCE OF STEELS AND VARIOUS SURFACE TREATMENTS

a. Carbon steel and surface treatments

A wide choice of finishes allow us to match the expected corrosion performance as closely as possible. The choice of appropriate

coating depends on the mounting restrictions and the harshness of the installation conditions. However, every environment has different sensitivity levels which make it impossible to provide a general classification which is valid in every case. For example, ZnMg usually performs better than GC which is unsuitable in sulphurous environments.

b. Stainless steel

Stainless steel is by definition resistant to corrosion. It protects itself by the formation of chromium oxide, and creates its own passivation layer which creates a barrier to the external environment and protects the steel. The traces of rust found on it are usually due to external contamination.

NB: Due to the formation of its passivating layer of chromium oxide, the salt spray test is not suitable for characterising

performance against corrosion (unlike products coated with sacrificial zinc).

c. Corrosivity category

The corrosivity category is a standard classification of environments based on atmospheric corrosion.

Solutions (continued)

DESCRIPTION OF TYPICAL ATMOSPHERIC ENVIRONMENTS ASSOCIATED WITH THE CORROSIVITY CATEGORY ESTIMATIONS (TAKEN FROM STANDARD ISO 9223)

CORROSIVITY CATEGORY ^a	CORROSIVITY	TYPICAL ENVIRONMENTS - EXAMPLES ^b	
		INDOOR	OUTDOOR
C1	Very low	Heated spaces with low relative humidity and low pollution (offices, school, museums)	Dry or cold zone, environment with minimal atmospheric pollution and very short-lived humidity (some deserts, Arctic, central Antarctica)
C2	Low	Unheated spaces with variable temperature and relative humidity. Low incidence of condensation and low pollution (warehouses, sports halls)	Temperate zone, environment with low atmospheric pollution ($SO_2 < 5 \mu g/m^3$) (rural areas, small towns) Dry or cold zone, atmospheric environment with short-lived humidity (deserts, subarctic region)
C3	Average	Spaces with moderate incidence of condensation and moderate pollution resulting from production processes (food processing factories, laundries, dairies)	Temperate zone, environment with average atmospheric pollution ($SO_2 = 5 \mu g/m^3$ to $30 \mu g/m^3$) or moderately affected by chlorides (urban areas, coastal areas with few chloride deposits) Subtropical and tropical zones with low atmospheric pollution
C4	High	Spaces with high incidence of condensation and severe pollution resulting from production processes (industrial processing plants, swimming pools)	Temperate zone, environment with very high atmospheric pollution ($SO_2 = 30 \mu g/m^3$ to $90 \mu g/m^3$) or affected by chlorides (polluted urban areas, industrial zones, coastal areas with neither splashing seawater nor exposure to the powerful effect of de-icing salts) Subtropical and tropical zones with average atmospheric pollution
C5	Very high	Spaces with very high incidence of condensation and/or very high levels of pollution resulting from production processes (mines, deposits for industrial exploitation, unventilated sheds in subtropical and tropical zones)	Temperate and subtropical zone, environment very with high atmospheric pollution ($SO_2 = 90 \mu g/m^3$ to $250 \mu g/m^3$) and/or strongly affected by chlorides (industrial areas, coastal areas, protected sites on the shoreline)
CX	Extreme	Spaces with almost permanent condensation or prolonged periods of exposure to extreme effects of humidity and/or high levels of pollution resulting from production processes (unventilated sheds in humid tropical zones allowing penetration of extreme pollution, including chlorides in the air and particular materials which encourage corrosion)	Subtropical and tropical zones (very long persistence of humidity on surfaces, environment with very high atmospheric pollution ($SO_2 =$ content higher than $250 \mu g/m^3$) including accompanying factors and production and/or strongly affected by chlorides (extreme industrial zones, offshore coastal areas, occasional contact with salt spray)

a - In atmospheres deemed to belong to class "CX", it is advisable to determine the corrosivity classification of atmospheres from the corrosion losses over a year

b - The concentration of sulphur dioxide (SO_2) should be determined at least once a year and expressed in the form of an annual average.



NOTE 1 - Chloride deposits in coastal areas depend primarily on variables affecting how sea salt is transported inland, in other words the wind speed and direction, local topography, presence of islands providing protection from the wind, distance between the exposure site and the sea, etc.

NOTE 2 - Extreme contamination with chlorides, such as salt spray, does not come under the scope of this international standard.

NOTE 3 - The corrosivity classification of the specific atmosphere present, for example in chemical industries, does not come under the scope of this international standard.

NOTE 4 - Protected surfaces which are not washed by rain water, in marine atmospheric environments where chloride deposits can occur and accumulate, may see their corrosivity increase substantially due to the presence of hygroscopic salts.

NOTE 5 - A detailed description of the types of indoor atmosphere belonging to the C1 and C2 corrosivity categories is given in ISO 11844-1. The corrosivity categories for C1 and C5 indoor atmospheres are defined and classified.

6) TABLE OF PRODUCT COMPATIBILITY

For consistency with the corrosion resistance of accessories and cable trays, and minimise corrosion breaking lines due to the galvanic couple, we recommend the following assemblies:

CABLE TRAYS		ACCESSORIES	SCREWS
GS / EZ	➤	GS / EZ	EZ / GS
HR	➤	ZnL / GC / HR	ZnL / HR
304L	➤	301 / 302 / 304L / 316L	304L / 316L
316L	➤	301 / 302 / 304L / 316L	304L / 316L
Painted	➤	Painted	Painted / EZ / EZ+

Notes:

- As far as combining metal products and PVC/GRP/Epoxy is concerned, there is no need for any restrictions.
- Combination of 301 and 302 accessories should be studied according to the operating environment, see E. Table of classes.
- Combining products made of HR, paint, GC, ZnL with GS or EZ does not cause any galvanic corrosion.
- Take note of the explanations about galvanic couples and the ratio of surface areas discussed in the "Galvanic corrosion" paragraph

7) TEMPERATURE

The operating temperature of our metal products ranges from -20°C to +120°C.

Paint and aesthetic appearance, practical use Polyester powder

For indoor dry environments, polyester powder paint on the raw (but treated) product has the advantage of increasing resistance to corrosion while improving its aesthetic appearance. It can also be useful for distinguishing between circuits. The shade should be specified on the order according to the RAL colour chart. It can also be used as a barrier against corrosion.

Plastic and PVC ageing

Unlike metals, plastics are not at risk of oxidation and corrosion. The material used guarantees 10 years' UV resistance and is fire-resistant at high temperatures (glow wire test at 960°). It can withstand temperatures from -20°C to +60°C. It has good resistance to impacts at temperatures as low as -5°C. It also has the advantage of being light to handle. Because of their insulating properties, PVC products do not need to be earthed.

Composite and performance - GRP

This combines the advantages of metals and plastic: excellent mechanical strength and fire resistance, which is why it is recommended for use in tunnels, without the disadvantages of metals: corrosion risk and UV resistance. Similarly to PVC, it also has the advantage of being light to handle and products made of GRP do not need to be earthed.

Application and Corrosivity category

In summary, since there is no point in issuing a classification of finishes which apply in all cases, due to the huge diversity of environments, we have listed below some recommendations for the main applications encountered.

ZINC WHISKERS PHENOMENON

The problem is that filaments of zinc around a micrometre in size can detach and damage electronic equipment. At present, this random phenomenon is mainly observed on the electrogalvanised coating, where these zinc metal filaments form.

The reason for it is not yet very well known, though it would appear that they are caused by internal stresses from the electrogalvanising process, which creates zinc whiskers. Nonetheless, some analyses of EZ coatings have shown an absence of zinc whiskers and there is no factual data in the Data Centres to quantify this phenomenon.

In view of this, the web giants and their associates are continuing to use EZ or other zinc-based alternatives such as pregalvanised steel (PG, GS, ZnAl, ZnMg), hot-dip galvanised (GC) steel, to which it is possible to add a coat of polyester powder paint. In some cases, these players choose "zinc free" solutions: PVC products, or raw steel coated only with polyester powder paint, etc.

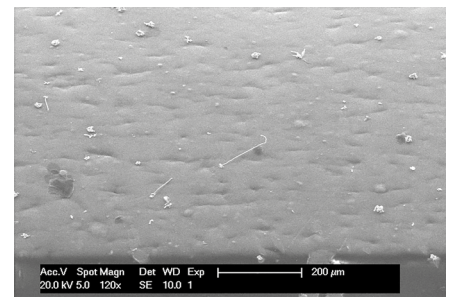

Type of site	Applications	Agression et atmosphere	Corrosivity category according to ISO 9223	Material/ min. recommended finish	
WORKING SPACES / DATACENTER	Power, VDI, supervision, ventilation control...	Indoor humidity	C1	GS / EZ / Polyester Powder / EZ+ black	
PUBLIC BUILDINGS	Closed infrastructures (museums, ...)	Indoor humidity	C1	GS / EZ / Polyester Powder / EZ+ black	
PUBLIC BUILDINGS	Open infrastructures (train station, car parks,...) inland	Exhaust gas Ambiant air (town centre)	C3	GC / HR	
PUBLIC BUILDINGS	Open infrastructures (train station, car parks,...) at the seaside	Exhaust gas Sea air	C4	HR	
		Exhaust gas Sea air with splashing salt water	C5	304L (301 and 302) 316L (301* and 302*) / PVC	
PUBLIC BUILDINGS	Swimming pool-type infrastructure	indoor contained area close to the water	Chlorine > 500ppm	C5	PVC
		indoor contained area and in technical equipment room separated from the water	Chlorine < 500ppm Chlorine > 500ppm	C4	316L PVC
	outdoor contained area installed far from the water	Chlorine < 200ppm	304L		
		Chlorine > 200ppm	PVC		
			Bleach, hydrochloric acids and disinfectant should be avoided as they corrode stainless steel		
HOSPITAL	Indoor technical equipment rooms and areas	Moderate condensation + pollution	C3	GC / HR	
ENERGY (WATER TREATMENT PLANT or biomass)	Outdoor	Sulphur in gas form ($90\mu\text{g}/\text{m}^3 < \text{SO}_2 < 250\mu\text{g}/\text{m}^3$) and organic acids	C5	316L PVC	
PHOTOVOLTAÏC SYSTEM	Outdoor	Ambiant air with humidity	C3	HR	
ROAD TUNNELS	Lighting and ventilation power supply	Confined Exhaust gas	C4	316L (301* and 302*) 304L (301 and 302) Composite / HR	
RAILWAY TUNNELS		Confined Non-sulphurous environment	C4	316L (301* and 302*) 304L (301 and 302) Composite / HR	
ENERGY (power stations)	Technical equipment rooms and areas	Battery acid gases	CX	316L / Composite	
OIL&GAS	Onshore	Gas & marine envionments Hydrocarbons (benzenes, phenols, aromatics)	C5	316L Composite	
OIL&GAS	Offshore	Marine envionment with splashing sea water Hydrocarbons (benzenes, phenols, aromatics)	CX	316L Composite	
		Marine envionment with splashing sea water Hydrocarbons (benzenes, phenols, aromatics) Non-sulphurous envrionments	CX	316L Composite	
INDUSTRIES	Chemicals	$\text{SO}_2 < 90\mu\text{g}/\text{m}^3$ Nitric and/or organic acids	C4	316L / PVC	
		Nitric and/or organic acids		304L (301 and 302) 316L (301* and 302*) / PVC	
INDUSTRIES	Manufacturing	Indoor / Oils / Humidity	C3	GC / ZnAl / ZnMg / ZnNi / ZnL	
INDUSTRIES	Food (manufacturing areas, laboratory)	Hydrogen peroxide, ammonia, phenolic derivatives, alcohol, disinfectants, aldehydes	C3 / C4	304L / 316L	
		Halogenes, bases, white wine, mustards		316L	
		Bleach, hydrochloric acids and disinfectant should be avoided as they corrode stainless steel			
MARINE/ SHIPBUILDING	Internal wiring on vessel/platform	Confined	C1	GS / EZ	
MARINE/ SHIPBUILDING	External wiring on vessel/plaform	Marine environment with splashing sea water	CX	316L Composite	



SAFE WORKING LOAD

When in use, the cable management system has to support the weight of the cables and other complementary products. The products safe working load (SWL) help adapt the installation configuration.

Explanation of cable tray load tests

The SWL or safe working load is the maximum load which can be applied safely during normal cable management use. It concerns a uniformly-distributed load which is expressed in daN/m for practical reasons.

TESTS ACCORDING TO IEC 61537

An increasing load is applied to the cable management system.

The safe working load obtained guarantees:

- A maximum longitudinal deflection of 1/100th of the span (example: 20 mm deflection for a distance between supports of 2000 mm)
- A maximum horizontal deflection of 1/20th of the cable tray width (example: 10 mm deflection for a cable tray width of 200 mm)
- A safety coefficient of 1.7

Test configurations:

There are three types of test: They are mainly distinguished by the location of the coupling in the span. For an identical product, you will get three different SWL values, depending on the type of test chosen.

- **Type 1:** A **coupling** must be located in the **middle** of the **first** span.

Associated mounting recommendation: This is the most restrictive configuration, which can offer a guarantee of safe loads in the installation without any conditions.



- **Type 2:** A **coupling** must be located in the **middle** of the **second** span.

Associated mounting recommendation: To guarantee safe loads, the installation should not contain a coupling in an end span.



The first span X^* can be smaller.

- **Type 3:** The position of the coupling is fixed, the length of the tested cable tray must be a multiple of the span.

Associated mounting recommendation: the installation should comply with the manufacturer's recommended coupling location.



** : junction present in one of the two spans

Within a chosen type of testing, restrictions may exist which lead to a multitude of possible test configurations

(cable trays fixed to the support or not, width of the support, varied span lengths, etc).

NEMA VE-1/CSA C22.2 NO. 126

NEMA VE-1 and CSA C22.2 No. 126 are two cable management standards which evolve in parallel with IEC 61537 but are drafted by a North American electrical committee. They also stipulate specific load test methods in order to declare the load capacity. The test is conducted on the cable management system uniformly loaded between two supports.

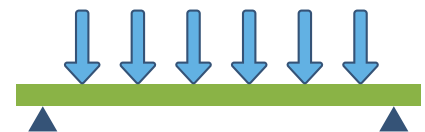

Destructive method:

This involves continuing until the system collapses. The load chosen for the SWL is then the collapse load divided by a safety factor of 1.5.

INSTALLATION POSSIBILITIES IN TYPE II OF IEC 61537

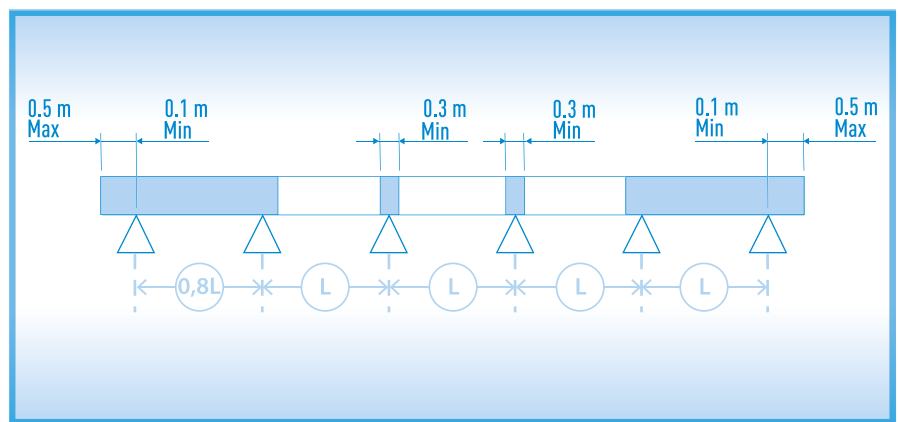
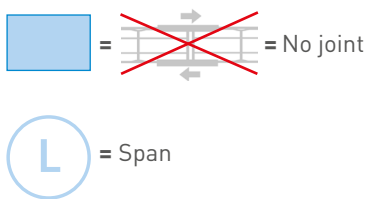

For the type II mounting, the first and last length must be between $0,8 \times \text{span} + \text{minimum } 10\text{cm}$, maximum $+50\text{cm}$, on 2 supports, without coupler. For the other lengths, couplers can't be placed on supports but can be placed elsewhere.

There is a table of conformity which is used to declare the product according to a particular designation.

Example of NEMA VE-1 applied to the United States

SPAN/LOAD CLASS DESIGNATION - USA (See Clauses 4.8.1, 4.8.2 and 6.1.2 (c))					
Load, kg/m (lb/ft)	m (ft)				
37 (25)	1.5 (5)	2.4 (8)	3.0 (10)	3.7 (12)	6.0 (20)
37 (25)	5AA	8AA	10AA	12AA	20AA
74 (50)	5A	8A	10A	12A	20A
112 (75)	-	8B	-	12B	20B
149 (100)	-	8C	-	12C	20C

Note: These ratings are also used in Mexico.

MANUFACTURER

There are also other manufacturer configurations which advise the results of maximum loads for the cable management system.

Hence, the declared load curves can come from a number of different configurations.

Maximum fill capacity

There is a general rule for calculating the fill capacity of a cable tray. For some projects, it is information which can be used as an initial assumption for measuring and adapting the supporting structure.

Calculation principle:

This works out the area of a cable tray cross-section. A full cable tray is deemed to contain a cable density of 0.25 kg/m/cm^2 .

Example: the area of a 50×300 cable tray cross-section (ie. $5 \times 30 \text{ cm}$) is 150 cm^2 (taking account of the internal dimensions). As a general rule, its resulting fill capacity is $0.25 \times 150 = 37.5 \text{ kg/m}$.

Note: Possible approximation $1 \text{ kgf} = 1 \text{ daN}$ (in reality $1 \text{ kgf} = 0.98 \text{ daN}$)



Explanation of bracket/hanger load tests in accordance with IEC 61537

Brackets are used in wall mounting scenarios. The safe working load, corresponding to a force, is declared in daN (1 kgf = 0.98 daN).

Hangers correspond to ceiling mounting scenarios. The significant SWL is then a torque and is declared in daN.m.

BRACKETS

The test consists of applying a load at two points for cable ladders or uniformly distributed for other types of cable tray. A support which is able to accommodate all types of cable tray is therefore tested at two points.

The declared SWL guarantees:

- A maximum deflection of 1/20th of the length of the bracket not exceeding 30 mm
- A safety factor of 1.7 before the product collapses

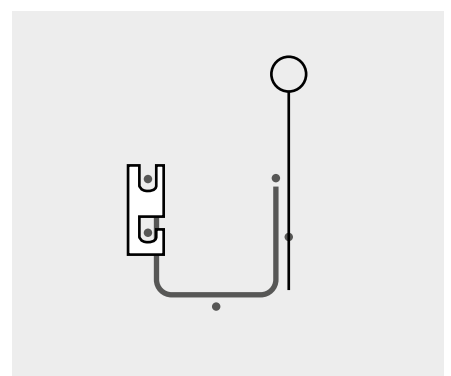
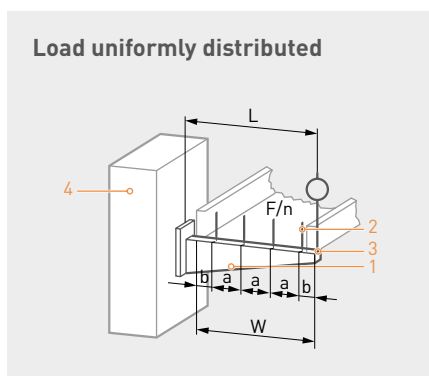

NUMBER OF POINT LOADS ACROSS THE WIDTH

NOMINAL WIDTH (mm)	NUMBER OF POINT LOADS
Up to 175 inclusive	1
From 175 to 300 inclusive	2
From 300 to 600 inclusive	4
More than 600	6

HANGERS

Two SWL values should be advised for a support fixed to the ceiling. All the declared SWLs guarantee:

- A maximum deflection of 1/20th of the total length of the hanger, while not exceeding 30 mm
- A safety factor of 1.7 before the product collapses

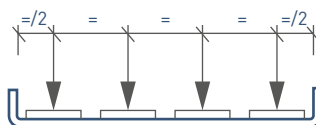
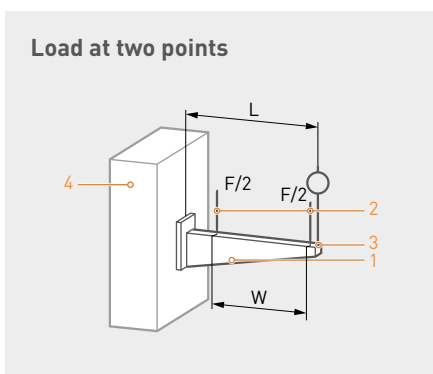

NB: In the case of short brackets with side fixings (CAT30, CM50, etc) the maximum deflection is measured at the end of the system.

The most typical SWL for a hanger is that corresponding to the bending moment, which defines the permissible torque for the hanger. The hanger is also defined by its SWL value under traction but this is less of a determining factor in the choice of support because it is easily sufficient in the majority of cases. As its value is often close to a tonne, it is not usually mentioned in the catalogues.

• Bending moment - hanger

The SWL test representing the hanger bending moment is conducted on a standard length of 800 mm. Force (F) is applied at the end of the hanger and the resulting moment (M) is calculated according to the formula below:

$$M = F \times 800 \text{ mm}$$

This test is used to check the hanger's horizontal behaviour.

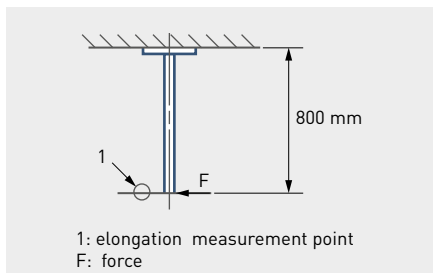

• Traction

This type of test indicates the permissible load for the support and is used to measure the strength of the plates.

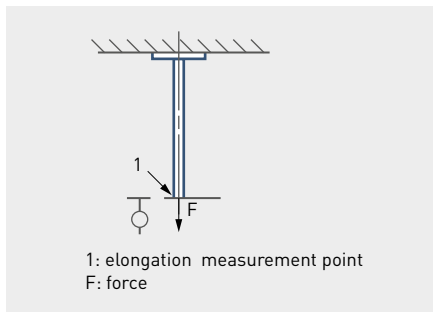

BRACKET, HANGER AND TORQUE: CALCULATION METHODOLOGY

Products are tested separately but in reality, the bracket can be fixed to the hanger. In this configuration, the loaded bracket generates torque which affects the hanger.

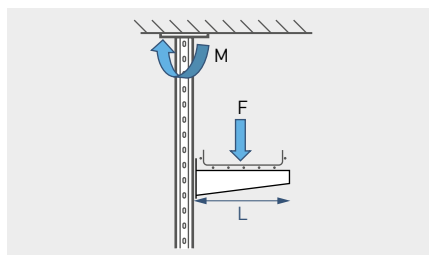

1: Calculation of force on the bracket - F.

This involves multiplying the distributed load applied and the linear weight of the cable tray by the span between supports. This results in a value written as F.

2: Conversion into torque

The resulting F above is deemed to be located in the middle of the bracket's cable tray. In the majority of cases, the cable tray widths correspond to the bracket lengths, L, and the resulting figure is at L/2. The torque is then determined on the hanger: $F \cdot (L/2)$.

This torque should be compared with the safe working load for the hanger's bending moment.

Case of a single hanger:

A 50 x 400 cable tray is installed on a hanger with brackets 500 mm wide. The desired configuration span is 1500 mm. We have specified that the cable trays are located at the end of the bracket.

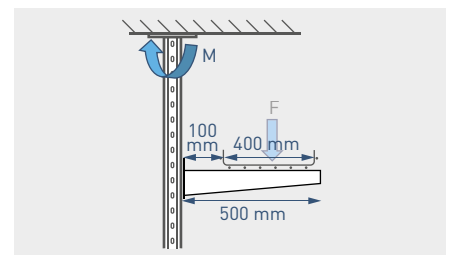

1: Calculation of force on the bracket - F

- Maximum weight generated by the cables - F1

The maximum load generated by the weight of the cables is:

$$5 \times 40 \times 0.25 \times 1.5 = 75 \text{ daN}$$

(maximum capacity x span)

Note:

Area in cm^2

Span in m

Force in daN

- Weight of cable tray - F2

For each 1.5 m in length, the cable tray weighs 8 kg.

$$\text{Total force on the bracket, } F = F1 + F2 = 75 + 8 = 83 \text{ daN}$$

2: Conversion into torque - M

The resulting F on the bracket is located at 300 mm from the hanger (100 + 200).

In the end, the torque generated is 83×0.3 which gives 25 daN.m.

It is therefore necessary to use a hanger with an SWL of 25 daN.m or more.

Case of a multiple hanger:

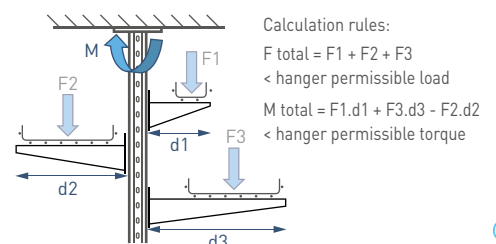

EARTHING

The earth network has an essential role in a cable management installation, ensuring the safety of people and property and making an effective contribution to good electromagnetic performance.

Definition

The earth network consists of all the interconnected metal parts in a building: girders, busbars, cable trays, metal structures of devices. These elements must be interconnected to ensure equipotentiality of the earth network, this function being provided by the protective conductor which connects the cable tray to the exposed conductive part as shown in the picture below. :

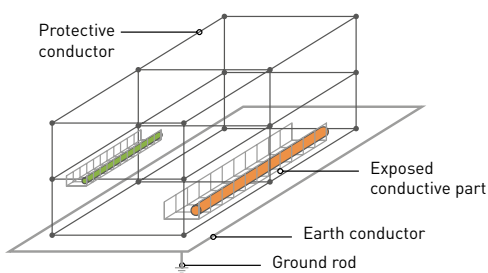

ADVANTAGES OF AN EQUIPOTENTIAL BONDING SYSTEM

The meshed equipotential bonding system works like a busbar system which dissipates any fault currents and stray currents to earth, which can as a result:

- Protect people and property
- Optimise electromagnetic performance

INSTALLATION - CASE OF CABLE MANAGEMENT

The extract from UTE C C15-900 "Installation électriques à basse tension - Guide Pratique" specifies how to earth cable trays and cable ladders with a bare copper protective conductor running along the cable trays or cable ladders, with a cross-section the same as the largest as the largest cross-section of the protective conductor used in the busbars concerned, with a maximum of 25 mm² and a minimum of 4 mm², connected approximately every 15 m to the cable trays or cable ladders.

However, there are exceptions for metal cable trays only holding or containing cables with insulation equivalent to class II*.

*Class II cables have double or reinforced insulation which ensures their safety in normal operating conditions.

EARTHING ACCESSORIES GUIDE

To prevent contact between copper and zinc, the copper earth connection braid must not be in direct contact with steel cable trays due to galvanic couple corrosion. Earthing products are available for this purpose, which should be chosen according to the type of metal the cable tray is made of. The table on the next page shows the product compatibility, taking account of the electrolytic compatibility rules seen earlier:

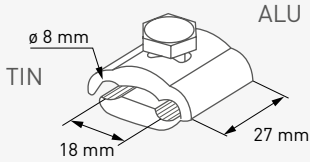
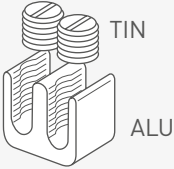
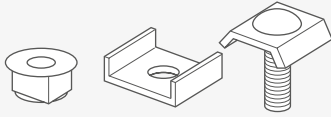
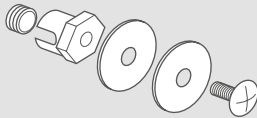
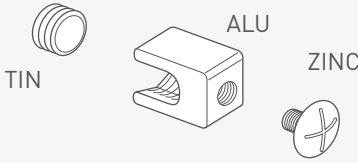
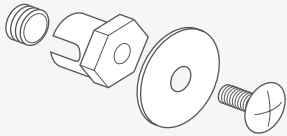
TYPE OF CABLE TRAY	NAME	ILLUSTRATION	POTENTIAL DIFFERENCE (MV)	CABLE TRAY FINISH
Wire	GRIFEQUIP 9 to 35 mm ²		ALU/ZINC = 310 TIN/CU = 230	EZ/EZ+/GC /HR
	GRIFEQUIP 2 6 to 35 mm ² (not available for USA and Canada)		ALU/ZINC = 310 TIN/COPPER = 230	EZ/EZ+/GC /HR
	ST. STEEL KIT 6 to 16 mm ²		CU/ST. STEEL = 320	STAINLESS STEEL
Wire	BLF 6 to 50 mm ²		BRASS/CU = 80 ALU/ZINC = 310 BRASS/CU = 80	PG/EZ/EZ+/GC/HR
			BRASS/CU = 440 CU/ST. STEEL = 320 ALU/BRASS = 440 BRASS/CU = 80	STAINLESS STEEL
Sheet metal and cable ladder	BAT35 6 to 35 mm		ALU/ZINC = 310 TIN/CU = 230	GS/GC/HR
	BLT 6 to 50 mm ²		BRASS/ALU = 440 CU/ST. STEEL = 320 ST. STEEL/BRASS = 400 BRASS/CU = 80	STAINLESS STEEL

According to the French practical guide UTE C15-900, equipotential bonding must be installed every 15 metres. For lengths of less than 15 metres, simply connect the metal cable trays to the exposed conductive part at each end. This makes it easy to dissipate any fault currents by closing the electrical circuit: which is then created by the cable tray.

NB: For polyester paint finishes applied to metal cable trays, simply remove the non-metallic top coat locally, using a file for example, to ensure good contact between the cable tray and the equipotential bonding.

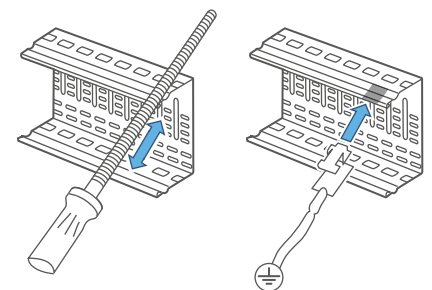

ELECTRICAL CONTINUITY

Invariably linked with earthing, electrical continuity is also fundamental to the safety of people and property and contributes equally to good electromagnetic performance of the installation.

Definition

The electrical continuity of a system is its ability to conduct the electric current. Every system is characterised by its resistance R . If $R = 0 \text{ Ohm}$: the system is a perfect conductor. The lower the system resistance, the better its electrical continuity.

ADVANTAGE OF EXCELLENT ELECTRICAL CONTINUITY

Setting every element in the cable management system to the same electric potential allows any fault currents to be dissipated and hence:

- Ensure the safety of people and property while preventing any risk of electrocution
- Contribute to the good electromagnetic performance of an installation by dissipating noise currents generated by disturbance.

REMINDER OF THE REQUIREMENTS OF STANDARD IEC 61537

- The resistance of steel cable tray lengths must not exceed 5 mOhm/m^* .
- The coupling between two lengths must provide maximum resistance of 50 mOhm .

The test results for our products satisfy the expected requirements.

* : For edition 3 of IEC 61537, the resistance of steel cable tray lengths should not exceed 50 mOhm/m .

NB: Non-metallic products made of PVC or composites are not affected by the issue of electrical continuity and do not therefore pose any electrical risks.

Contribute to the good electromagnetic performance of an installation by preventing noise currents generated by disturbance

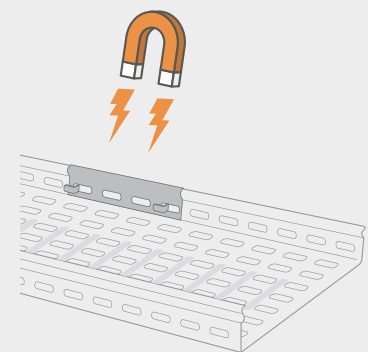

The metal structure of the cable tray absorbs some of the electromagnetic disturbance and converts it into noise current.

Ensure the safety of people and property while preventing any risk of electrocution

No coupler = DANGER!



Coupler = SAFETY!



SHORT-CIRCUIT

Despite the use of protective equipment for electrical power systems, there is still a risk to people and equipment associated with power transmission. Our systems incorporate methods for controlling these risks with customised high-performance cable supports.

Definition

A short-circuit results from accidental connection of two points on an electrical circuit with different potential. It puts the safety of people and property at risk. Depending on where it occurs, it can reach a very high current and is often a cause of fires.

Main causes of short-circuits:

- damage to the insulation caused by ageing, wear or mechanical impact
- a broken conductor
- a conductive tool falling into or being inserted in a circuit

Standard IEC 61914

Cable trays are not subject to the restrictions concerning short-circuits in the standard.

When this phenomenon occurs, an electromagnetic force proportional to the square of the current is created. This can generate a risk for the external environment by causing the system to move, hence the need to attach the cables to the cable trays with clamps.

Thus in the overall cable management system, only the clamps attaching the cables to the cable trays are subject to IEC 61914.

The short-circuit withstand test, involving electromagnetic forces, is conducted by connecting one end of the cable to a three-phase supply and the other end to a short-circuiting busbar on which all three phases are interconnected. The cable is held in at least 5 places along the cable tray.

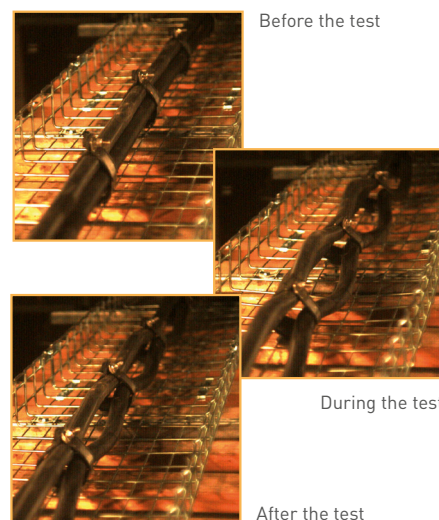

Conclusion

As a result of the tests we have observed an absence of permanent deformation in the cable management system, which has been able to absorb the impacts.

ELECTROMAGNETIC PERFORMANCE

The cable management system's electromagnetic performance characterises its ability to protect its cables from external electromagnetic disturbance; if this is controlled, the data carried by the cables and surrounding equipment will remain intact.

Principle

Electromagnetic disturbance is emitted by a source disturbing a victim. The way in which electromagnetic disturbance is transmitted is called coupling. Electromagnetic disturbance appears when all three elements: source, coupling and victim come together.

If it has excellent electrical continuity and is integrated in the installation's equipotential bonding system, a metal cable tray reduces the coupling's impact and thus contributes to good EMC of the electrical installation.

SOURCE → **COUPLING** → **VICTIM**

Example of sources: variable-frequency drives, mobile phones, lightning, power cables, etc.

Example of victims: computers, IT equipment, data cables, etc.

Electromagnetic performance can be improved by suppressing or minimising these three elements. Since it affects the coupling, the cable tray contributes to an improved EMP.

The golden rules

There are several ways to reduce electromagnetic disturbance:

- Comply with the principle of separating power and data cables

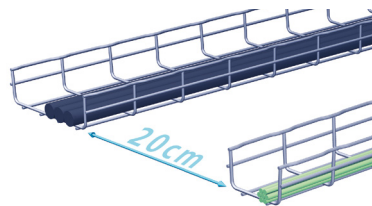

- Make cables from different families cross at right angles

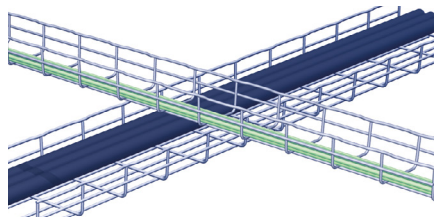

- Ensure electrical continuity: metal cable tray and couplers

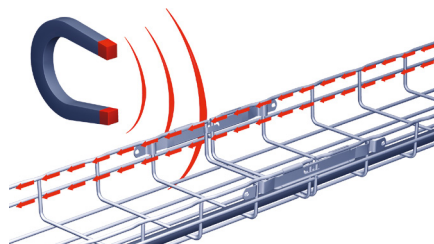

- Connect the cable trays to the bonding system (every 15 to 20 m)

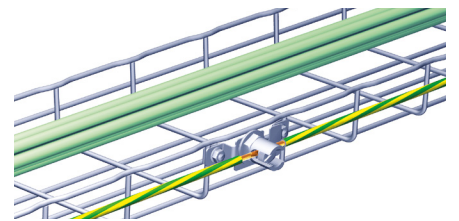

- Use of cables with high-quality screening (see p.36)
- Optimum cable layout

The shading indicates the best screening performance

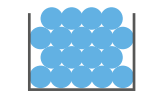
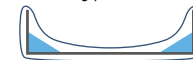

Not recommended

Not recommended

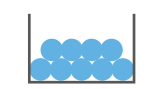

Recommended

Recommended

Distance and screening installation configuration

- Adaptation to the cable tray characteristics: thickness, height, width, addition of covers.
- Optimised distribution of different cable types in the cable tray (data cables kept apart from power cables).

Non-conforming



Conforming

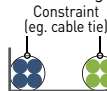

or



or

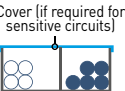

Recommended

(the compartment order can be reversed)

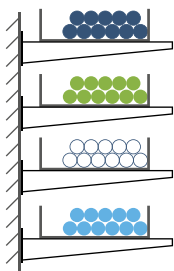

- electricity supply wiring
- auxiliary circuits (ie. fire alarm, door opening device)
- data technology wiring
- sensitive circuits (ie. measurement or instrumentation)

NOTE: All the metal parts are connected to the equipotential bonding system, in accordance with Article 5.

Standard EN 50174-2 2009 "Information technology - Cabling installation - Part 2: Installation planning and practices inside buildings" gives information on the minimum distances in the standard which must be complied with.

The principle is that the higher the quality of the screening, the shorter the distance between cable trays must be to prevent magnetic radiation. It advises that a distance of 22.5 cm will ensure correct system operation, but this distance can be reduced, depending on the cable quality and type and the cable tray dimensions.

The plan is for this standard to evolve into a method consisting of assigning a correction factor to the minimum distance between source/victim cables at no-load so as to be able to deduce a minimum distance when one of them is protected by a cable tray.

This method is based on the screening results obtained from the tests conducted in accordance with IEC 61000-4-5 "Electromagnetic compatibility - Part 4-5: Testing and measurement techniques - Surge immunity test".

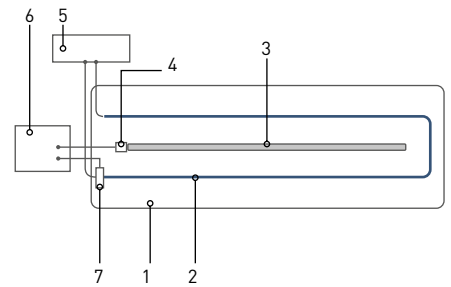

- 1 Non-conductive table without metal components
- 2 Turn (Source)
- 3 Current loop (Victim) – Add a schematic from the spec around it
- 4 Current probe
- 5 Current generator
- 6 Measuring equipment – Oscilloscope measuring the current transmitted and received
- 7 Current probe

The screening measurement corresponds to the ratio between the induced current and the magnetic field in the cable when it is not protected ($I_{ref, max}$) and when when it is protected by a cable tray ($I_{sample, max}$).

$$SE (dB) = 20 \times \log \left(\frac{I_{ref, max}}{I_{sample, max}} \right)$$

FIRE RESISTANCE

During a fire, the systems in place to ensure that people can be evacuated (emergency lighting, fans, emergency exit, fire alarm, etc) must retain their integrity. In their cable-carrying role, cable trays also contribute to safety in the event of a fire. There is no international standard on the fire resistance of cable management systems, just local standards. However, one of them stands out somewhat more on the international stage, the German standard DIN 4102-12.

Standard DIN 4102-12

The whole system is discussed in this standard. This means the cable tray, supports, accessories and some cables from one manufacturer in particular.

The standard's compliance test is conducted in a furnace at least 3 m long, for a period of 30, 60 or 90 minutes according to a temperature-rise curve going up to 1000°C. An additional load is applied to the cable management system via metal chains.

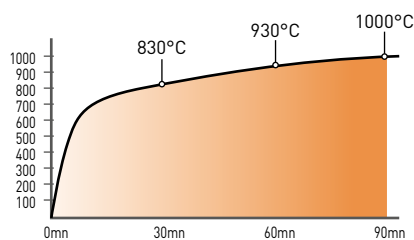

The approval awarded (E90, E60, E30) is obtained for a predefined span and load. The validation criterion for fire resistance systems is defined by whether the electrical equipment still works when it comes out of the furnace. For an approved configuration, the cables and cable trays see their mechanical properties definitely altered but they have fulfilled their purpose: to ensure the installation lasts for a defined period.

These tests are conducted in recognised independent laboratories which then deliver the results via third-party certificates. These laboratories guarantee that the tests described in standard DIN 4102-12 are conducted in the correct conditions.

Other local standards

• Standards STN 92 0205 and ZP-27/2008

Standards applied in Slovakia and the Czech Republic, the fire resistance test method is similar to DIN 4102-12. The main difference concerns measuring the temperature inside the contained area. However, there is a correlation between the STN 92 0205 and ZP-27/2008 classifications with DIN 4102-12.

• Standard AS/NZS 3013-2005

Applicable in Australia and New Zealand, standard AS/NZS 3013-2005 targets cable management more specifically. Indeed, its sole purpose is to simulate filling with cables. This standard awards classification WS5X based on maximum deformation (100 mm) of systems tested for 120 minutes.

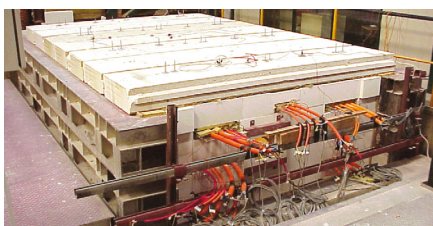

PERIOD	APPROVAL
> 30 min	E 30
> 60 min	E 60
> 90 min	E 90

Before the test



During the test

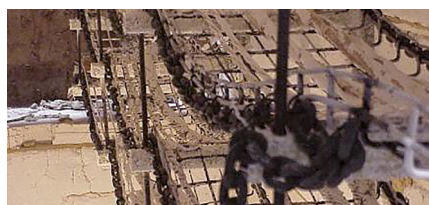

After the test

Examples of configurations tested in accordance with standard DIN 4102-12:

The whole system is discussed in this standard. This means the cable tray, supports, accessories and some cables from one manufacturer in particular.

The standard's compliance test is conducted in a furnace at least 3 m long, for a period of 30, 60 or 90 minutes according to a temperature-rise curve going up to 1000°C. An additional load is applied to the cable management system via metal chains.

CABLOFIL			P31		8GL04
HANGER + CB	TF+R41	CSNC	CB	CURVED BRACKET	C40
<ul style="list-style-type: none"> - Span: 1500 mm - Dimensions: CF54 100 to 400 - Load: 15 kg/m - Material: EZ, GC, HR, 316L E30 - E60 - E90 	<ul style="list-style-type: none"> - Span: 1200 mm - Dimensions: CF54 200 to 400 - Load: 10 kg/m - Material: GS, EZ, GC, HR E30 - E60 - E90 - Span: 1500 mm - Dimensions: CF54 400 - Load: 15 kg/m - Material: 316L E30 - E60 - E90 	<ul style="list-style-type: none"> - Span: 1250 mm - Dimensions: CF54 100 to 200 - Load: 10 kg/m - Material: GS, EZ, GC, HR E30 - E60 - E90 - Span: 1250 mm - Dimensions: CF54 200 - Load: 10 kg/m - Material: 316L E30 - E60 - E90 	<ul style="list-style-type: none"> - Span: 1500 mm - Dimensions: P31 60/100 to 400 - Load: 20 kg/m - Material: GS E30 - E60 - E90 	<ul style="list-style-type: none"> - Span: 1500 mm - Dimensions: P31 60/100 - Load: 10 kg/m - Material: GS E30 - E60 - E90 	<ul style="list-style-type: none"> - Span: 1500 mm - Dimensions: GL04 100/200 to 400 - Load: 20 kg/m - Material: GS E60

Other configurations are available on request.



POWER CABLES

Current generates energy and temperature rise in the copper or aluminium cable core: this is the Joule effect. When several cables are juxtaposed in the same cable management system, there are precautions which can be taken to avoid creating too high a temperature rise in the assembly.

A reminder of some physics terms

The resistance R of a conductor is proportional to the resistivity ρ of the material, cross-section S and length L : $R = \rho * (L/S)$.

The power P dissipated by Joule effect: $P = R * I^2$ where I is the current intensity.

The conductor resistivity and cross-section have an immediate impact on the Joule effect and are characteristics to be considered when selecting cables.

Standard IEC 60364-5-52

IEC 60364-5-52 "Low-voltage electrical installations – Selection and erection of electrical equipment - Wiring systems" offers information about the size of cables according to the permissible current required.

The permissible current is calculated from the rated current, to which various normative weightings are applied. The following cable trays are deemed to be identical:

- solid and perforated sheet metal cable trays
- cable ladders and wire cable trays

Indeed, the open structure of wire cable trays and cable ladders naturally allow good cable ventilation and limits their temperature rise. Thus, for the same type of cable (copper or aluminium), wire cable trays or cable ladders can allow a cable with a smaller diameter to be used.

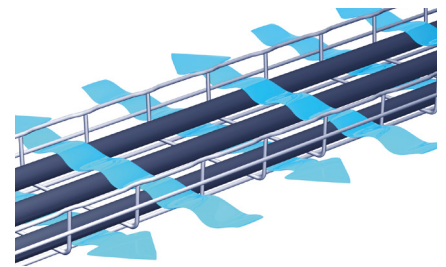

The other factors concern:

- the conductor material: copper or aluminium
- the type of cable insulation: PVC or EPR or mineral
- the ambient temperature
- the installation configuration: multi-level cable trays, number and position of cables in the tray

Example of cable sizing table compared to the permissible current calculated below

RATED CONDUCTOR CROSS-SECTION mm ²	REFERENCE METHODS FOR TABLE A. 52-1						
	MULTICORE CABLES		SINGLE-CORE CABLES				
	2 live conductors	3 live conductors	2 live conductors side by side	3 live conductors in a trefoil arrangement	3 live conductors in flat layers		
					Side by side	Horizontal	Vertical
	2	3	4	5	6	7	8
1	28	24	-	-	-	-	-
2.5	38	32	-	-	-	-	-
4	49	42	-	-	-	-	-
6	67	58	-	-	-	-	-
10	91	77	-	-	-	-	-
16	108	97	121	103	107	138	122
25	135	120	150	129	135	172	153
35	164	146	184	159	165	210	188
50	211	187	237	206	215	271	244
70	257	227	289	253	264	332	300
95	300	263	337	296	308	387	351
120	346	304	389	343	358	448	408
150	397	347	447	395	413	515	470
185	470	409	530	471	492	611	561
240	543	471	613	547	571	708	652

Comparative temperature-rise tests

In order to compare the contribution of different types to cable performance, tests have been conducted by LCIE (French Central Laboratory for the Electrical Industries). Power cables are supplied by a constant current. The power dissipated by Joule effect is then compared, allowing classification of the cable tray types as illustrated by the diagram below:

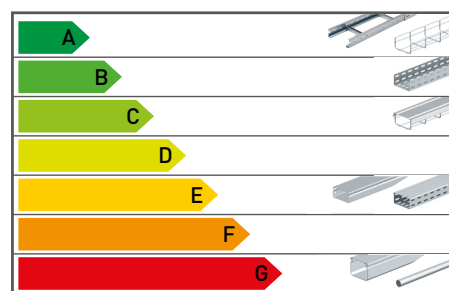

DATA CURRENT

To manage complexity and manage data installations require high-performance, scalable cabling. Cable tray accessories make it easier to organise, distribute and make the various cabling systems safe.

Data security and integrity

INSTALLATION

In order to preserve the transmission characteristics of data cables, use the correct cable sleeve, and cross-section geometry, and apply the correct mechanical stress measured during installation.



Our wire and sheet metal cable trays have safety edges to protect the cables as well as the installers.

USE

The metal structure of the cable tray and its excellent electrical continuity (provided by the coupling) integrated in a high-quality bonding system, is an effective means of combatting electromagnetic disturbance.

VDI cables are laid rather than pulled through the cable tray and it is normal to use a few dedicated accessories in order to comply with the minimum bending radii for these cables: Table below

DESIGNATION - PRODUCT NAME	FAS-ROLLER	COLSON™	CABLOGRIP	DEV50	DEV100	CENTRAL DROPOUT
PHOTO						
COMPATIBILITY	Wires/Sheet metal 	Wires/Sheet metal 	Wires 	Wires 	Wires 	Wires
"+" FUNCTION FOR CABLE INSTALLATION	Limits effects of kinking and abrasion	Measured cable clamping	Minimum 50 mm radius guaranteed	Minimum 50 mm radius guaranteed	Minimum 50 mm radius guaranteed	

FIBRE OPTIC DATA CABLES

The development of fibre optics is the direct result of the increasing demand for high-speed data exchanges between various terminals. Its immunity to electromagnetic disturbance and signal transmission characteristics make it for the ideal medium for high-speed transmission.

Definition

Optical fibre routes the digital data via luminous flux within a very thin glass cable. The transmission factor of an optical fibre, given in decibels (dB), defines the quality of data transmission.

Composition of a fibre optic cable

Optical waves are propagated in the optical core, made of silica, fused quartz or plastic. The core diameter varies from 50 μm to 200 μm .

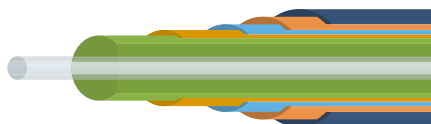

Light ray

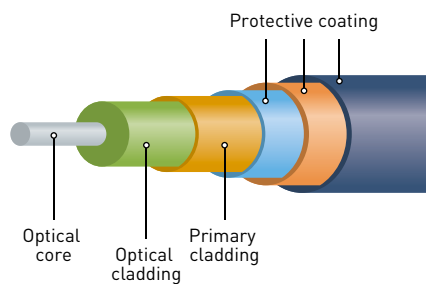

connections over very long distances (several miles) and in backbones (the nerve centre of a high-speed network).



MULTIMODE OPTICAL FIBRE

The core and the cladding constitute successive layers of glass. It is commonly used for short and medium distances, local area networks and the main cable management systems in buildings.

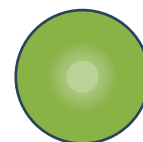

The optical cladding confines the optical waves in the core: the light ray is propagated by successive reflections on the walls formed by the optical cladding. The protective coating, usually a layer of plastic of 25 to 1000 microns, confers the fibre with remarkable mechanical properties.

Types of optical fibre

SINGLE-MODE OPTICAL FIBRE

The core is very thin and allows the luminous flux to propagate almost in a straight line. This type of fibre was historically used for telecoms services,

Maximal length of channel by fibre optic application

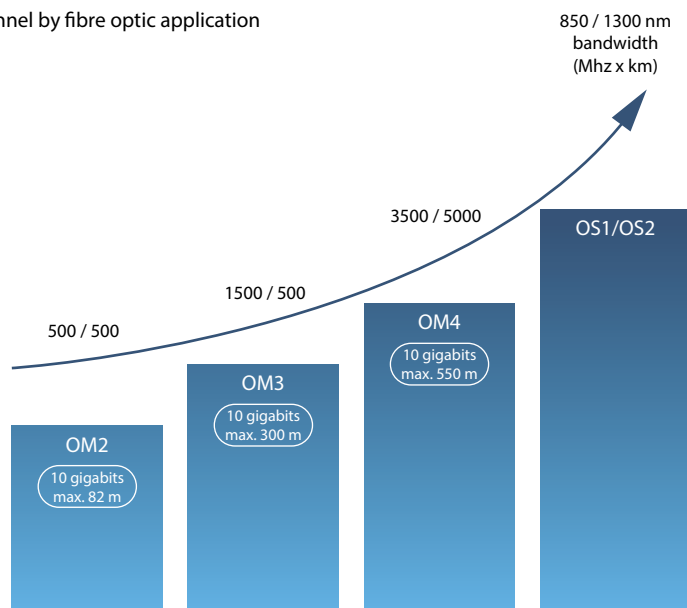

Advantages

- Most reliable and secure transmission method
- Very high data rate, up to 100 Gb/s
- Low signal attenuation: transmission over long distances
- Immunity to electromagnetic disturbance
- Lack of electromagnetic radiation
- Resistance to corrosion

Duplex applications, functioning on Duplex LC

Duplex	OM3	OM4	OM5	OS1a	OS2
10Gbps	300m ⁽¹⁾	400m ⁽¹⁾	400m ⁽¹⁾	2km ⁽¹⁾	10km ⁽¹⁾
25Gbps	70m ⁽¹⁾	100m ⁽¹⁾	100m ⁽¹⁾	2km ⁽¹⁾	10km ⁽¹⁾
40Gbps	240m ⁽²⁾	350m ⁽²⁾	440m ⁽²⁾	2km ⁽¹⁾	10km ⁽¹⁾
50Gbps	70m ⁽¹⁾	100m ⁽¹⁾	100m ⁽¹⁾	2km ⁽¹⁾	10km ⁽¹⁾
100Gbps	70m ⁽²⁾	100m ⁽²⁾	150m ⁽²⁾	2km ⁽¹⁾	10km ⁽¹⁾
200Gbps	N/A ⁽³⁾	N/A ⁽³⁾	N/A ⁽³⁾	2km ⁽¹⁾	10km ⁽¹⁾
400Gbps	N/A ⁽³⁾	N/A ⁽³⁾	N/A ⁽³⁾	2km ⁽¹⁾	10km ⁽¹⁾

1: Standard
2: Multi-Source Agreement
3: Not applicable



COPPER DATA CABLES

Twisted pairs

This type of cable is most commonly used in telephony and for data in local area networks. The pairs, consisting of 2 twisted copper wires, are isolated from one another with plastic and enclosed in a sheath.

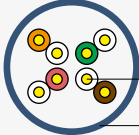
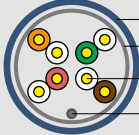
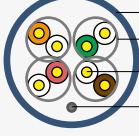
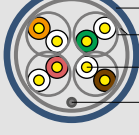
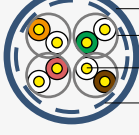
NEW REF.	OLD REF.	DESCRIPTION	PHOTO OF CABLE CROSS-SECTION
U/UTP	UTP	Unshielded twisted pairs	 <ul style="list-style-type: none"> Copper wire Outer cladding
F/UTP	FTP	Foiled twisted pairs	 <ul style="list-style-type: none"> Outer cladding Aluminium foil Copper wire Drain wire
U/FTP	FTP PIMF	Shielded twisted pairs	 <ul style="list-style-type: none"> Outer cladding Aluminium foil Copper wire Drain wire
F/FTP	FFTP	Double foiled twisted pairs	 <ul style="list-style-type: none"> Outer cladding Aluminium foil Copper wire Drain wire
S/FTP	SFTP	Shielded foiled twisted pair	 <ul style="list-style-type: none"> Outer cladding Aluminium foil Copper wire Braid

For effective protection against electromagnetic disturbance, the FTP and SFTP cable shielding must be connected to ground at each end.

New standards for new performance levels

Reliability and longevity

The operator's two main concerns are the reliability and longevity of installations. We have performed various types of test in wire and sheet metal cable trays in order to measure the impact of a cable overload on signal quality.

CATEGORY	CLASS	SPEED	FREQUENCY
Cat. 5	D	≤ 100 Mbps	100 MHz
Cat. 5e	D	≤ 100 Mbps	155 MHz
Cat. 6	E	≤ 1 Gbps	250 MHz
Cat. 6a	Ea	≤ 10 Gbps	500 MHz
Cat. 7	F	≤ 10 Gbps	600 MHz
Cat. 7a	Fa	≤ 10 Gbps	1000 MHz
Cat. 8	I	≤ 40 Gbps	2000 MHz

LABORATORY TESTS

The aim is to gain a detailed understanding of the short- and long-term effects of using cable trays for Category 6a cables. 70 metres of Cat 6a cable with LCS³ connectors were tested without a load, then subjected to mechanical stress, corresponding to a 130 kg/m weight of stacked cables. Using an appropriate certified measuring device, we took hundreds of measurements including the NEXT, FLEX, LCL, Attenuation, Return Loss tests, etc.

Results of the NEXT test - Comparison of P31 Sheet Metal/Cablofil Wire cable tray. Cablofil curve in blue/P31 curve in orange

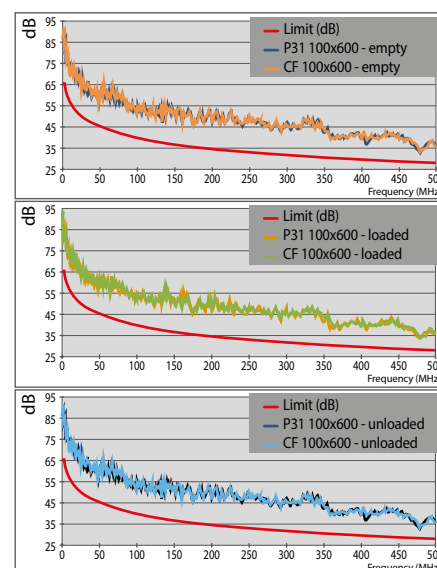

The loading applied (130 kg/m) is much higher than the majority of actual cases and what might represent the weight of the cables in a full cable tray. With a load such as this applied, the impact on signal quality for the Category 6a cable tested is a maximum of 3% for the sheet metal cable tray and 2% for the wire cable tray.

Conclusion

These in-house tests demonstrate that there is no signal quality difference with wire or a solid surface cable tray for structured cabling solutions.





FOLLOW US
ALSO ON

- @ legrand.com
-  youtube.com/user/legrand
-  facebook.com/Legrand
-  twitter.com/Legrand
-  pinterest.com/legrandgroup
-  instagram.com/legrandnews



Head office
and International Department
87045 Limoges Cedex - France
Tel: + 33 (0) 5 55 06 87 87
Fax: + 33 (0) 5 55 06 74 55