

# BENNING

## Operating manual

Translation of the German original version

**BENNING ST 755+ / ST 760+**

5284 / 08/2023 en



# Legal notice

## Notes concerning the documentation

Ensure that the applicable documentation is used for this product. For safe handling, knowledge that is provided in these instructions is required.

The product may only be handled while following this documentation, particularly the safety instructions and warnings it contains. The personnel must be qualified for the respective task and have the capability to recognise risks and prevent possible dangers.

## Manufacturer and holder of rights

BENNING Elektrotechnik und Elektronik GmbH & Co. KG  
Münsterstraße 135 – 137  
46397 Bocholt  
Germany  
Phone: +49 2871 / 93-0  
E-mail: [duspol@benning.de](mailto:duspol@benning.de)  
Internet: [www.benning.de](http://www.benning.de)  
Commercial register Coesfeld HRA no. 4661

## Copyright

© 2023, BENNING Elektrotechnik und Elektronik GmbH & Co. KG  
All rights reserved.

This document – particularly all of the contents, texts, photographs and graphics that it contains – are protected by copyright.

No part of this documentation or the associated contents may be reproduced or edited, copied or distributed using electronic media in any form (printed, photocopied or using any other method) without express written permission.

## Disclaimer

The contents of the documentation has been checked to ensure that it corresponds to the hardware and software described. Nevertheless, deviations cannot be ruled out, so Benning cannot guarantee complete correspondence. The contents of this documentation are checked at regular intervals, and any corrections that are needed are contained in the versions that follow.

## General non-discrimination

Benning is aware of the importance of language with regard to the gender equality and endeavors to take this into account at all times. To improve readability, we have refrained from consistently using differentiating formulations.

# Table of contents

<b>1</b>	<b>Introduction.....</b>	<b>10</b>
1.1	Naming convention .....	10
1.2	General notes.....	11
1.3	History .....	12
1.4	Service & support.....	12
<b>2</b>	<b>Safety .....</b>	<b>13</b>
2.1	Warning system .....	13
2.2	Standards applied .....	13
2.3	Symbols used.....	14
2.4	Intended use .....	15
2.5	Special types of risks .....	17
<b>3</b>	<b>Scope of delivery .....</b>	<b>18</b>
<b>4</b>	<b>Transport and storage.....</b>	<b>20</b>
4.1	Packing and transport .....	20
4.2	Storage.....	20
<b>5</b>	<b>Device description.....</b>	<b>21</b>
5.1	Device structure .....	21
5.2	Type plate .....	22
5.3	Screen setup .....	23
5.4	Menu structure .....	25
<b>6</b>	<b>General operation .....</b>	<b>27</b>
6.1	Switching the device ON/OFF .....	27
6.2	Operating elements.....	27
6.3	Login .....	28
6.4	Buttons in the footer .....	28
6.5	Operating the list view.....	29
6.6	Operating the test view .....	31
6.7	Operating the Smart menu.....	33
<b>7</b>	<b>Functions.....</b>	<b>34</b>
7.1	Database.....	34
7.2	Backup copies.....	35
7.3	User administration .....	36
7.4	Expert settings .....	36

7.4.1	Customer-specific limits .....	36
7.4.2	Customer-specific visual inspection .....	37
7.4.3	Customer-specific test procedures.....	37
7.4.4	Customer-specific device templates .....	37
7.4.5	Customer-specific templates.....	38
7.4.6	Update.....	38
7.4.7	Factory settings.....	38
7.5	General test procedure .....	38
7.5.1	Automatic testing .....	39
7.5.2	Manual testing .....	40
7.5.3	Terminology used in test procedures.....	40
7.6	Device information .....	42
7.7	Individual tests .....	42
7.7.1	Protective conductor resistance.....	42
7.7.2	Insulating resistance .....	43
7.7.3	Protective conductor current .....	44
7.7.4	Contact current.....	44
7.7.5	Device leakage current (medical electrical devices).....	44
7.7.6	Patient leakage current (medical electrical devices).....	45
7.7.7	Functional test.....	45
7.7.8	Cable continuity test.....	46
7.7.9	Safety extra-low voltage.....	46
7.7.10	Voltage of the welding circuit .....	46
7.7.11	Contact current of the welding circuit.....	47
7.7.12	PRCD .....	47
7.7.13	Power distributors .....	48
7.8	Remote control.....	48
7.9	Optional accessories.....	49
7.9.1	Three-phase testing with the BENNING MA 4 .....	49
7.9.2	Three-phase testing with the BENNING MA 3 .....	50
7.9.3	Three-phase testing with the BENNING MA 2-16.....	50
7.9.4	Single-phase and three-phase testing with the leakage current clamp.....	51
7.9.5	Barcode scanner (optional).....	51
7.9.6	RFID scanner (optional).....	53
7.9.7	Printer (optional).....	54
7.9.8	Keyboard (optional).....	55
<b>8</b>	<b>Configuration .....</b>	<b>56</b>
8.1	Setting the system data.....	56
8.2	Setting the device data.....	58
8.3	Managing the network settings .....	58
8.3.1	Establishing a connection via WLAN .....	59
8.3.2	Establishing a connection via Bluetooth.....	59
8.4	Managing the expert settings.....	60
8.4.1	Managing customer-specific limits .....	60
8.4.2	Creating a customer-specific visual inspection .....	61

8.4.3	Creating customer-specific test procedures .....	61
8.4.4	Managing customer-specific device templates (test sample templates) .....	63
8.4.5	Managing templates .....	63
8.5	Managing a user .....	64
8.6	Managing a database .....	65
8.6.1	Creating (“New”) and selecting e. g. a database .....	65
8.6.2	Managing test samples .....	66
8.6.2.1	“Change”, “Copy” and “Delete” using the test sample as an example .....	67
8.7	Zero balance, cable and probe calibration .....	69
8.8	Setting the display, time and language .....	70
<b>9</b>	<b>Testing .....</b>	<b>71</b>
9.1	Requirements for tests and measurements .....	71
9.2	Connecting the safety measuring lines .....	74
9.3	Automatic testing .....	76
9.4	Manual testing .....	77
9.5	Individual tests .....	79
9.5.1	Testing the protective conductor resistance .....	79
9.5.2	Testing the insulating resistance .....	80
9.5.3	Testing the protective conductor current .....	83
9.5.4	Testing the contact current .....	84
9.5.5	Testing the device leakage current .....	86
9.5.6	Testing the patient leakage current .....	87
9.5.7	Functional test .....	90
9.5.8	Cable continuity test .....	91
9.5.9	Testing the safety extra-low voltage .....	92
9.5.10	Testing the voltage of the welding circuit .....	93
9.5.11	Testing the contact current of the welding circuit .....	94
9.5.12	Testing of PRCDs .....	95
<b>10</b>	<b>Maintenance .....</b>	<b>96</b>
10.1	Maintenance schedule .....	96
10.2	Making the device free of voltage .....	96
10.3	Cleaning the device .....	97
10.4	Calibrating the device .....	97
10.5	Installing an update (GUI, firmware) .....	98
10.6	Recovering the password .....	99
<b>11</b>	<b>Technical data .....</b>	<b>100</b>
<b>12</b>	<b>Disposal and environmental protection .....</b>	<b>101</b>
<b>13</b>	<b>Appendix .....</b>	<b>102</b>
13.1	Automatic test procedures .....	102

13.1.1	Automatic test procedures according to EN 50678 (VDE 0701) and EN 50699 (VDE 0702)	102
13.1.2	Automatic test procedures according to EN 62353 (VDE 0751-1)	105
13.1.3	Automatic test procedures according to EN 60974-4 (VDE 0544-4)	106
13.2	Manual test procedures	107
13.2.1	Manual test procedures according to EN 50678 (VDE 0701) and EN 50699 (VDE 0702)	107
13.2.2	Manual test procedures according to EN 62353 (VDE 0751-1)	108
13.2.3	Manual test procedures according to EN 60974-4 (VDE 0544-4)	109
13.3	Test standards	110
13.4	Factory settings and measured values	111
13.4.1	Factory settings and measured values – Protective conductor resistance tests	111
13.4.2	Factory settings and measured values – Insulating resistance tests	112
13.4.3	Factory settings and measured values – Current measuring method	113
13.4.4	Factory settings and measured values – Functional test	114
13.4.5	Factory settings and measured values – Cable continuity test	114
13.4.6	Factory settings and measured values – Safety extra-low voltage test	115
13.4.7	Factory settings and measured values – PRCD test	115
13.4.8	Factory settings and measured values – Voltage of the welding circuit test	116
13.4.9	Factory settings and measured values – Times	116
13.5	Measuring methods	117
13.6	Remote control	118
13.6.1	Remotely controlling the device via the PC	118
13.6.2	Remotely controlling the device using a smartphone or tablet	119
<b>Index</b>		<b>120</b>

# Table of figures

Figure 1 BENNING ST 755+ / BENNING ST 760+ device structure .....	21
Figure 2 Type plate (exemplary) .....	22
Figure 3 Screen layout .....	23
Figure 4 General operation .....	29
Figure 5 Test view .....	31
Figure 6 BENNING MA 4 .....	49
Figure 7 BENNING MA 3 .....	50
Figure 8 BENNING MA 2-16 .....	50
Figure 9 BENNING CM 9-1 / BENNING CM 9-2 .....	51
Figure 10 Balance / calibration .....	69
Figure 11 Device view – jacks .....	75
Figure 12 Testing the protective conductor resistance (connection diagram exemplary for VDE 0701 and VDE 0702, circuit diagram) .....	79
Figure 13 Testing the insulating resistance, Class I (connection diagram exemplary for VDE 0701 and VDE 0702, circuit diagram) .....	80
Figure 14 Testing the insulating resistance, Class II (connection diagram exemplary for VDE 0701 and VDE 0702, circuit diagram) .....	81
Figure 15 Testing the insulating resistance, Class III (connection diagram exemplary for VDE 0701 and VDE 0702, circuit diagram) .....	82
Figure 16 Testing the protective conductor current (connection diagram, circuit diagram) .....	83
Figure 17 Testing the contact current, Class I (connection diagram exemplary for VDE 0701 and VDE 0702, circuit diagram) .....	84
Figure 18 Testing the contact current, Class II (connection diagram exemplary for VDE 0701 and VDE 0702, circuit diagram) .....	85
Figure 19 Testing the device leakage current (connection diagram for VDE 0751-1, circuit diagram) .....	86
Figure 20 Testing the patient leakage current, Class I (connection diagram for VDE 0751-1, circuit diagram, applied parts of type F) .....	88
Figure 21 Testing the patient leakage current, Class II (connection diagram for VDE 0751-1, circuit diagram, applied parts of type F) .....	88
Figure 22 Functional test (connection diagram, circuit diagram) .....	90
Figure 23 Cable continuity test (example: multiple socket, connection diagram, circuit diagram) .....	91
Figure 24 Testing the safety extra-low voltage, Class I (connection diagram, circuit diagram) .....	92
Figure 25 Testing the voltage of the welding circuit (connection diagram, circuit diagram) .....	93
Figure 26 Testing the contact current of the welding circuit (connection diagram, circuit diagram) .....	94
Figure 27 Testing of PRCDs (connection diagram) .....	95

# List of tables

Table 1	History.....	12
Table 2	Symbols on the device.....	14
Table 3	General symbols and buttons in the header.....	23
Table 4	Symbols for test sample and protection class in the header.....	24
Table 5	Menu structure – Main menu.....	25
Table 6	Menu structure – Settings.....	26
Table 7	Operating the screen.....	27
Table 8	Buttons in the footer.....	28
Table 9	Operating the list view.....	30
Table 10	Status messages.....	30
Table 11	Test view buttons.....	31
Table 12	“Test result” screen.....	32
Table 13	Proceeding with the test report.....	33
Table 14	Smart menu – Main menu.....	33
Table 15	Database structure (exemplary).....	34
Table 16	Database contents.....	34
Table 17	Functions of the “Automatic test”.....	39
Table 18	Leakage current measurement (test standard and protection class).....	45
Table 19	PRCD tests.....	47
Table 20	Setting options for system data.....	56
Table 21	Network settings.....	58
Table 22	“Test procedure” screen.....	62
Table 23	How to manage templates.....	64
Table 24	Functions of the “Database administration”.....	65
Table 25	“Devices” screen.....	66
Table 26	Display, time and language.....	70
Table 27	Maintenance schedule.....	96
Table 28	Technical data.....	100
Table 29	Test procedures according to EN 50678 (VDE 0701) and EN 50699 (VDE 0702) for Class I.....	102
Table 30	Overview of test procedures according to EN 50678 (VDE 0701) and EN 50699 (VDE 0702) for Class I (1 to 16).....	104
Table 31	Overview of test procedures according to EN 50678 (VDE 0701) and EN 50699 (VDE 0702) for Class I (17 to 32).....	104
Table 32	Test procedures according to EN 50678 (VDE 0701) and EN 50699 (VDE 0702) for Class II.....	104
Table 33	Test procedures according to EN 50678 (VDE 0701) and EN 50699 (VDE 0702) for Class III.....	105
Table 34	Overview of test procedures according to EN 50678 (VDE 0701) and EN 50699 (VDE 0702) for Class II (1 to 6) / Class III (1).....	105
Table 35	Test procedures according to EN 62353 (VDE 0751-1) for Class I.....	105
Table 36	Test procedures according to EN 62353 (VDE 0751-1) for Class II.....	106
Table 37	Overview of test procedures according to EN 62353 (VDE 0751-1) for Class I (1 to 5) / Class II (1 to 2).....	106
Table 38	Test procedures according to EN 60974-4 (VDE 0544-4) for Class I.....	106



Table 39 Test procedures according to EN 60974-4 (VDE 0544-4) for Class II .....	106
Table 40 Overview of test procedures according to EN 60974-4 (VDE 0544-4) for Class I (1 to 3) / Class II (1) .....	107
Table 41 Manual test procedures according to EN 50678 (VDE 0701) and EN 50699 (VDE 0702) .....	107
Table 42 Manual test procedures according to EN 62353 (VDE 0751-1) .....	108
Table 43 Manual test procedures according to EN 60974-4 (VDE 0544-4) .....	109
Table 44 Overview of test standards .....	110
Table 45 Overview of test steps .....	111
Table 46 Factory settings of the limits for protective conductor resistance tests (conductor 5 m, 1.5 mm <sup>2</sup> ) ..	111
Table 47 Measured values according to measuring specifications – Protective conductor resistance tests...	111
Table 48 Factory settings of the limits for insulating resistance tests .....	112
Table 49 Measured values according to measuring specifications – Insulating resistance tests .....	112
Table 50 Factory settings of the limits for protective conductor current test .....	113
Table 51 Factory settings of the limits for contact current test .....	113
Table 52 Factory settings of the limits for leakage current test .....	113
Table 53 Protective conductor resistance – Alternative leakage current measuring method .....	113
Table 54 Measured values according to measuring specifications – Differential current measuring method .	113
Table 55 Measured values according to measuring specifications – Direct current measuring method .....	114
Table 56 Measured values according to measuring specifications – Functional test .....	114
Table 57 Factory settings of the limits for cable continuity test .....	114
Table 58 Measured values according to measuring specifications – Cable continuity test .....	114
Table 59 Measured values according to measuring specifications – Safety extra-low voltage test .....	115
Table 60 Factory settings of the limits for PRCD-AC .....	115
Table 61 Factory settings of the limits for PRCD-A und PRCD-F .....	115
Table 62 Factory settings of the limits for PRCD-B und PRCD-B+ .....	115
Table 63 Factory settings of the limits for PRCD 2-pin, 3-pin, K, S and S+ .....	115
Table 64 Measured values according to measuring specifications – PRCD .....	115
Table 65 Factory settings of the limits for voltage of the welding circuit test .....	116
Table 66 Measured values according to measuring specifications – Voltage of the welding circuit test .....	116
Table 67 Factory settings of the limits for times .....	116

# 1 Introduction

The appliance tester BENNING ST 755+ / ST 760+ described here (in the following only referred to as “device”) is intended for the safety testing of electrical test samples (DUTs). The basic versions of the device enable you to perform the following tests and measurements:

Standard	Measurement	ST 755+	ST 760+
EN 50678 (VDE 0701)	Test procedure for electrical devices after repair	X	X
EN 50699 (VDE 0702)	Test procedure for electrical devices in case of periodic testing	X	X
EN / IEC 62353 (VDE 0751-1)	Periodic testing and tests after repair of medical electrical devices or systems	X	X
EN / IEC 60974-4 (VDE 0544-4)	Periodic inspection and testing of arc welding equipment	-	X

## Further information

<https://tms.benning.de/st760plus-st755plus>



On the Internet, you will find the following additional information directly at the specified link or at [www.benning.de](http://www.benning.de) (product search):

- Operating manual of the device in several languages
- Further information depending on the device (e. g. brochures, technical reports, FAQs)

## 1.1 Naming convention

### Battery

In this operating manual, the term “battery” is used to refer to accumulators.

## 1.2 General notes

### Target group

This operating manual is intended for the following groups of people:

- Qualified electricians and electrotechnically trained personnel

### Required basic knowledge

To understand these operating manual, you will need general knowledge of testing and measuring equipment. Moreover, you will need basic knowledge of the following issues:

- General electrical engineering

### Purpose of the operating manual

This operating manual describes the device and provides you information about how to handle it.

Keep this operating manual in a safe place for later use. Read this operating manual before handling the device and follow the instructions.

---

### NOTE

#### Disclaimer of liability

Please make sure that any person using the device has read and understood the instructions of this operating manual before handling the device and that the instructions are adhered to in all points. Non-observance of this operating manual might result in product damage, property damage and/or personal injury.

Benning assumes no liability for damage and malfunctions resulting from the failure to observe the instructions in this operating manual.

---

The devices are subject to continuous further development. Benning reserves the right to make changes to the device's design, configuration and technology. The information in this operating manual corresponds to the state of technical knowledge at the time of printing. For this reason, no claims for certain device characteristics can be derived from the contents of this operating manual.

Information in this operating manual can be changed at any time without prior notice. Benning is not obligated to make amendments to this operating manual or to keep it up to date.

Direct any technical questions to Technical Support [[▶](#) page 12].

### Figures and drawings

This operating manual includes figures and drawings for general illustrative purposes. The functional possibilities and representations can deviate from the present device.

### Test standards

The content of this operating manual is intended to describe the appliance tester and in no way replaces the currently applicable test standards.

## Trademarks

All trademarks used are the property of their respective owners, even if they are not separately marked as such.

## Declaration of conformity

The declaration of conformity for this device is held by the manufacturer for the responsible authority. You can request it from Technical Support [▶ page 12].

## 1.3 History

Release number	Amendments
08/2023	<ul style="list-style-type: none"> <li>Initial release</li> </ul>

Table 1: History

## 1.4 Service & support

Please contact your specialty retailer or the BENNING Service Center for any repair or service work that might be required.

### Technical Support

Please contact our Technical support for technical questions on handling the device.

Phone:	+49 2871 93-555
Fax:	+49 2871 93-6555
E-Mail:	helpdesk@benning.de
Internet:	www.benning.de

### Returns management

Easily and conveniently use the BENNING returns portal for a quick and smooth returns processing:

<https://www.benning.de/service-de/retourenabwicklung.html>

Phone:	+49 2871 93-554
E-Mail:	returns@benning.de

### Return address

BENNING Elektrotechnik und Elektronik GmbH & Co. KG  
 Retourenmanagement  
 Robert-Bosch-Str. 20  
 D - 46397 Bocholt

## 2 Safety

### 2.1 Warning system

This operating manual contains notes that must be taken into consideration for your personal safety and in order to avoid injuries and damage to property. Warnings about your personal safety and to prevent personal injuries are marked with a warning triangle. Warnings on sole prevention of material damage are shown without a warning triangle. The warnings are shown in descending order depending on the hazard level as follows.



#### **⚠ DANGER**

##### **Extremely dangerous situation for humans**

If you do not pay attention to this warning, irreversible or deadly injuries will occur.



#### **⚠ WARNING**

##### **Hazard to humans**

If you do not pay attention to this warning, irreversible or deadly injuries could occur.



#### **⚠ CAUTION**

##### **Minor hazard to humans**

If you do not pay attention to this warning, minor or moderate injuries could occur.



#### **NOTICE**

##### **Danger to property, not to persons**

If you do not pay attention to this warning, material damage could occur.

If multiple hazard levels occur, the warning for the highest respective hazard level will be used. In addition, a warning about personal injuries can also include a warning about material damage.

### 2.2 Standards applied

The device has been built and tested in compliance with the following standards and has left the factory in perfectly safe condition.

- IEC / DIN EN 60529 (VDE 0470-1)
- IEC / DIN EN 61010-1 (VDE 0411-1)
- IEC / DIN EN 61010-2-032 (VDE 0411-2-032)
- IEC / DIN EN 61010-031 (VDE 0411-031)
- IEC / DIN EN 61326-1 (VDE 0843-20-1)
- IEC / DIN EN 61557-1 (VDE 0413-1)
- IEC / DIN EN 61557-2 (VDE 0413-2)
- IEC / DIN EN 61557-4 (VDE 0413-4)
- IEC / DIN EN 61557-6 (VDE 0413-6)
- IEC / DIN EN 61557-16 (VDE 0413-16)

## 2.3 Symbols used

### Symbols on the device

















Symbol	Meaning
	Please observe the information provided in this operating manual in order to avoid dangers.
	Warning of electrical danger! Please observe the information provided in this operating manual in order to avoid dangers.
CAT II	Measuring category II is applicable to testing and measuring circuits which are directly connected to user connections (e. g. sockets) of the low-voltage mains installation.
	The device complies with EU directives.
	The device complies with directives applicable in Great Britain.
	At the end of product life, dispose of the unserviceable device via appropriate collecting facilities provided in your community.
	The device is provided with protective insulation (protection class II).
	Please observe the operating manual.
	(DC) direct voltage or direct current
	(AC) alternating voltage or alternating current
	Earth (voltage to earth)
	Bluetooth
	WLAN
	SD memory card
	USB interface
	PC Micro-USB interface
	Network interface

Table 2: Symbols on the device

## 2.4 Intended use

Only use the device within the framework of the corresponding technical data. Any operating conditions that deviate from this shall be considered as improper use. Solely the user of the device shall be liable for any resulting damage.

Please note the following:

- In case of improper use, the liability and warranty claims become void. Solely the user of the device shall be liable for any damage resulting from improper use. Uses not complying with the intended use include e. g.:
  - Hardware or software changes without the knowledge and approval of Benning
  - Use of components, accessories, spare or replacement parts that have not been released and approved for the respective application by Benning
  - Non-observance, manipulation, changes or misuse of the operating manual or the instructions and notes contained therein
  - Any form of misuse of the device
  - Any use other than or beyond that described in this operating manual
- Warranty and liability claims are generally excluded if the damage is the result of force majeure.
- If any prescribed services are not performed regularly or not on time, according to the manufacturer's specifications during the warranty period, a decision about a warranty claim can only be made once the findings are available.

Direct any questions to Technical Support [▶ page 12].

### Using the device

Please observe the following basic obligations when using the device:

- The device may only be used in a technically perfect and safe condition. Always check the device for damages before using it.
- The personnel must be qualified for the respective task.
- Electrical safety tests of portable electrical equipment can be carried out by competent persons or qualified electricians. Due to the definitions of the German technical guideline for operational safety "Competent persons – Specific requirements – Electrical hazards" (TRBS "Befähigte Personen – Besondere Anforderungen – Elektrische Gefährdungen"), it is no longer possible to let the testing be carried out only by electrotechnically trained persons. However, the electrotechnically trained person can take over tasks in a testing team (e. g. qualified electrician / electrotechnically trained person) within the framework of periodic tests and thus support the qualified electrician.
- Observe relevant regulations on occupational safety and health as well as those on environmental protection.
- The device may only be used inside buildings and in dry environments.
- Do not use the device in potentially explosive environments.
- Use suitable (approved) safety measuring lines.
- Use suitable (approved) safety measuring accessories.
- Operate the display only with your fingers or the rubberised side of the enclosed stylus. Doing this, do not apply any pressure to the display.
- Use the device only in a TN, TT or IT power supply network [▶ page 56] with a maximum of 230 V + 15 % / 400 V that complies with the applicable safety regulations.
- Connect the device only to a single-phase mains with 230 V, 50 Hz and a pre-fuse of 16 A.
- Do not connect any external voltage to the test socket, to the built-in jacks or the IEC connector.

- The device is not intended for measurements in electrical installations! The test sample must be free of external voltage (disconnected from the mains).
- For the testing of test samples with the warning “High leakage current!”, the test must be carried out by qualified electricians only!
- For device protection and for functional testing, the test voltages are monitored. In case of a fault, an error will be indicated on the display. Measurement will be interrupted. In case of a fault current of  $\geq 25$  mA, the device will be switched off within a period of 100 ms to 200 ms.
- In order to detect short-circuits and body contacts occurring behind the switch-on elements (e. g. switch, thermostat, relay) of the test sample, the test sample must be switched on.
- Tap the “Pause” button to interrupt the measurement. During the pause, the test socket remains live!



### **WARNING**

#### **Dangerous voltage**

Danger to life or serious injury is possible due to contact with high electric voltage in case of incorrect operation.

- Do not touch the bare measuring probe tips of the safety measuring lines or the bare contacts of the optional alligator clips, Only touch the safety measuring lines in the area intended for your hands.
- Please note that dangerous testing voltages might be present at the device during insulating resistance measurement. These might also be applied to the measuring circuit if safety measuring lines are contacted.
- Connect the safety measuring lines to the correspondingly marked measuring jacks of the device and check them for tight fit.
- Only use approved safety measuring lines.
- Attach the protective caps to the contact tips of the safety measuring lines (circuits of overvoltage category CAT III or IV).
- When disconnecting the measuring circuit, first remove the live safety measuring line (phase) and then the neutral safety measuring line from the measuring point.

## **Securing the device**

If the device is not in a technically perfect and operationally safe condition, safe operation is no longer guaranteed. Make sure that the following measures are taken:

- Switch off the device.
- Remove the device from the measuring point.
- Secure the device against unintentional operation.

The following characteristics indicate that safe operation is no longer guaranteed:

- The device (housing, connecting cables, plugs or safety measuring lines) shows visible damage or is damp/wet.
- The insulation of the safety measuring lines is damaged.
- The device does not work properly in compliance with regulations (e. g. errors during measurements).
- The device shows recognisable consequences of prolonged storage under inadmissible conditions.
- The device shows recognisable consequences of extraordinary stress due to transport.



## 2.5 Special types of risks

---



### **DANGER**

#### **Bare conductors or main line carriers**

Danger to life or serious injury is possible due to contact with high electric voltage when working with bare conductors or main line carriers.

- Please observe relevant regulations on occupational safety and health.
  - If necessary, use appropriate protective equipment.
- 



### **WARNING**

#### **Dangerous voltage**

Danger to life or serious injury is possible due to contact with high electric voltage when working on live components or equipment. Even low voltages from 30 V-AC and 60 V-DC on can be dangerous to human life!

- Please observe relevant regulations on occupational safety and health.
  - If necessary, use appropriate protective equipment.
-

## 3 Scope of delivery

The scope of delivery of the device includes the following components:

- 1 x appliance tester BENNING ST 755+ (item no.: 050332) or appliance tester BENNING ST 760+ (item no.: 050334)
- 1 x SD memory card  $\geq 4$  GB (item no.: 10003760)
- 2 x safety measuring line (black / red) (item no.: 10173716)
- 1 x mains cable (3 x 1.5 mm<sup>2</sup>, l = 500 mm), shock-proof plug to IEC connector (item no.: 10009127)
- 1 x 2 m test probe, 2-pin, (black) with 4 mm probe tip and double plug-in contact (item no.: 10150829)
- Set of safety measuring lines BENNING TA 1 (item no.: 044124)  
Ø 4 mm alligator clips, 2-piece, red / black, professional version, CAT III 1 000 V, 36 A
- 1 x input stylus for touchscreen operation (item no.: 10009128)
- 1 x quick reference guide

### Optional accessories

#### Software:

- PC software BENNING PC-Win ST 750-760 (item no.: 047002)

#### Barcode scanners and labels:

- 1D-USB barcode scanner for reading 1D barcodes (item no.: 009369)
- 1D/2D barcode scanner with USB for barcodes, QR codes and Data Matrix codes, (item number: 009373)
- 1D/2D cordless barcode scanner with Bluetooth® function (item no.: 009374)
- PVC barcode labels with consecutive numbering on rolls (rolls of 1 000 pieces) (item no.: 756301), further number ranges available (up to item no.: 756310)

#### RFID scanner and tags:

- Multi-frequency RFID scanner for reading out the UID no., with USB interface (item no.: 009372)
- RFID tag, self-adhesive, for attachment onto the housing, diameter: 18 mm, PU (packaging unit) = 100 tags (item no.: 044156)
- RFID tag (tag-type), for attachment by means of cable ties, l 43 mm x w 34 mm, PU = 100 tags (item no.: 044158)

#### Printer, labels and badges:

- Portable label and log printer BENNING PT 2 (item no.: 10225404)
- Test badges "next test" (300 pieces, item no.: 756212)
- Label rolls for BENNING PT 2 (item no.: 10225408)
- Thermographic paper rolls for BENNING PT 2 (item no.: 10225407)
- Thermographic paper refill rolls for BENNING PT 1 (20 pieces, item no.: 044151)

#### Test probes:

- 5 m test probe, 2-pin, (black) with 4 mm probe tip and double plug-in contact (item no.: 10154024)
- 2 m test probe, 2-pin, (black) with 4 mm probe tip and double plug-in contact (item no.: 10150829)
- Brush probe for gentle contacting of accessible conductive parts (item no.: 10217861)

**Keyboards:**

- Industrial keyboard with USB interface (item no.: 044154)
- Wireless keyboard with USB receiver (item no.: 044161)

**Leakage current clamp and measuring adapters:**

- TRUE RMS leakage current clamp BENNING CM 9-1 (item no.: 044682) or BENNING CM 9-2 (item no.: 044685) for measuring leakage current, differential current and protective conductor current (complies with EN 61557-13, EN 61557-16).
- Measuring adapter for BENNING CM 9-1 / CM 9-2, for  $I_{PE}$  measurements (using the differential current and direct current measuring method) as well as load current measurements. The conductors are led through individually and provided with double insulation:
  - 16 A CEE coupling – CEE connector, 5-pin (item no.: 044127)
  - 32 A CEE coupling – CEE connector, 5-pin (item no.: 044128)
  - Shock-proof plug / coupling, single-phase (item no.: 044131)

**Measuring adapters for single-phase and three-phase loads:**

- BENNING MA 4 measuring adapter, (16 A CEE 3-pin, 16 A/32 A CEE 5-pin) for single-phase/three-phase loads with CEE extension cables (item no.: 044162)
- Mains connection cable for BENNING MA 4 measuring adapter, 16 A CEE connector – 32 A CEE coupling, 5-pin (item no.: 044163)
- BENNING MA 3 measuring adapter, (16 A CEE 3-pin, 16 A/32 A CEE 5-pin) for single-phase/three-phase loads with CEE extension cables (item no.: 044159)
- BENNING MA 2-16 measuring adapter, (16 A CEE 3-pin, 16 A/32 A CEE 5-pin) for three-phase loads (item no.: 044160)
- Measuring adapter 3-fold CEE (16 A CEE 3-pin, 16 A/32 A CEE 5-pin) for single-phase/three-phase loads (item no.: 044147)
- Measuring adapters for single-phase/three-phase loads:
  - 16 A CEE coupling (5-pin) – shock-proof plug (item no.: 044122)
  - 32 A CEE coupling (5-pin) – shock-proof plug (item no.: 044123)
  - 16 A CEE coupling (3-pin) – shock-proof plug (item no.: 044143)
  - 32 A CEE coupling (3-pin) – shock-proof plug (item no.: 044144)

**Third-party software**

- PC software “cerhost.exe” for remote control of the device [▶ page 118]
  - Direct download:  
<https://forum.fs-net.de/wcf/index.php?attachment/379-cerhost-zip/>
  - Download overview (download cerhost.zip only):  
<https://forum.fs-net.de/index.php?thread/4391-cerhost-display-and-control-your-windows-ce-device-from-your-desktop/>
- “CerHost” app from Microit Electronics SRL for remote control of the device [▶ page 118]  
You can find the Android™ or iOS™ app in the respective app store under the search term “CerHost”.

## 4 Transport and storage

### 4.1 Packing and transport

Damage due to improper transport will result in exclusion of liability. Make sure that the following measures are taken:

- Do not expose the device to shocks.
- If the device has been transported under conditions deviating from the operating temperature or maximum relative air humidity specified in the Technical data [▶ page 100], the device needs an acclimatisation phase of at least two hours before being switched on.
- Please keep the original packaging for later dispatch (e. g. for calibration).
- Dispatch the device in its original packaging only. Transport damages due to improper packaging are excluded from warranty.

If the original packaging is no longer available, you can reorder it from the returns management [▶ page 12]:

- Outer package (item no.: 10043820)
- Moulded parts (item no.: 10043821)

### 4.2 Storage



#### NOTICE

##### Improper storage

The device can be damaged due to improper storage.

- Follow the conditions for storage indicated.

Ensure the following measures during storage:

- Close the device case before storing the device.
- Store the device in a suitable location. Storage locations with the following conditions are recommended:
  - Dry and dust-free spaces
  - No direct exposure to sunlight
  - Keep away from chemical substances
- Do not store the device outdoors without protection.
- Ensure that the values in the technical data [▶ page 100] for the following ambient conditions are adhered to at the storage location:
  - Storage temperature
  - Relative humidity (non-condensing)
- Condensation can form if there are large temperature fluctuations. Ensure that the permissible value of 20 K per hour is not exceeded at the storage location.
- For optimum storage, the device case is equipped with an automatic pressure valve near the carrying handle on the front of the device case.

# 5 Device description

## 5.1 Device structure

The device comes in a closable device case. The cover of the device case can be removed via two cotter pins in the hinges.

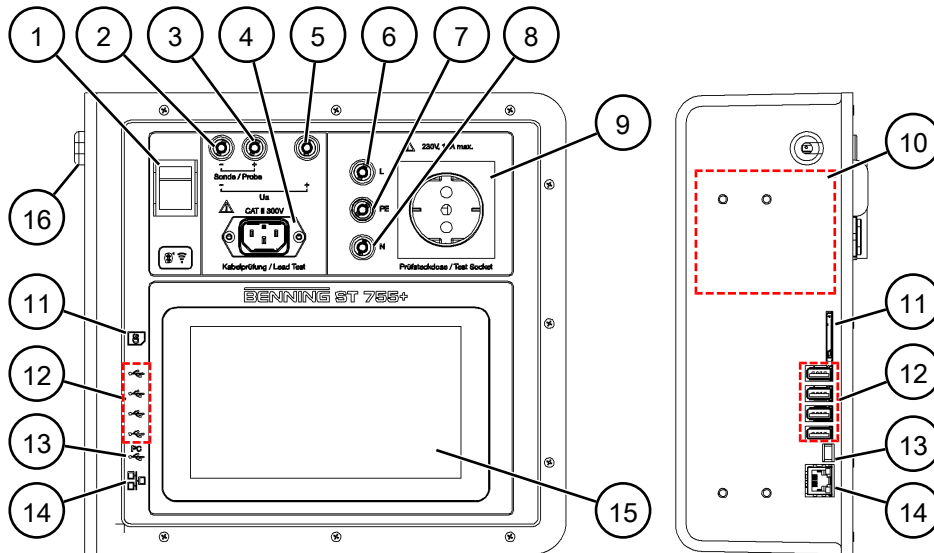

Figure 1: BENNING ST 755+ / BENNING ST 760+ device structure

1	Mains switch (O – I)	2	Black measuring jack "-" for test probe and open-circuit voltage ( $U_a$ )
3	Black measuring jack "+" for test probe	4	IEC socket for cable test
5	Red measuring jack "+" for open-circuit voltage ( $U_a$ )	6	Black "L" jack (is connected to the "L" of the test socket, connection is disconnected when mains voltage is applied to the test socket)
7	Green-yellow calibration jack "PE"	8	Blue "N" jack (is connected to the "N" of the test socket, connection is disconnected when mains voltage is applied to the test socket)
9	Test socket	10	Type plate
11	SD memory slot	12	USB-A interfaces
13	USB Mini-B interface	14	Ethernet interface
15	7" touch display	16	Mains connection cable

### Built-in battery

- The device is provided with an integrated battery in order to maintain operation in the event of a power failure or when changing the test station. Do not switch off the device if you disconnect the mains supply due to a test station change.
- The correct battery state of charge (SoC) is only displayed after the first full charge to 100 %. The SoC remains at 0 % until full charging has been completed.
- As soon as the battery has been discharged to 0 %, the battery will initially charge slowly (approx. 30 minutes). Then, the actual charging takes place with a higher charging current.
- If the battery is exhausted and the power supply from the mains is missing, the device switches off automatically. It is recommended to always switch off the device after use via the ON/OFF.
- The battery will be charged automatically in mains operating mode with the device being switched on.

## 5.2 Type plate

The type plate is located inside the housing case on the left side of the device.

When contacting our Technical support [▶ page 12], have the serial number of the device at hand. You will find the serial number on the type plate.

The following figure shows an example of the setup of the type plate:

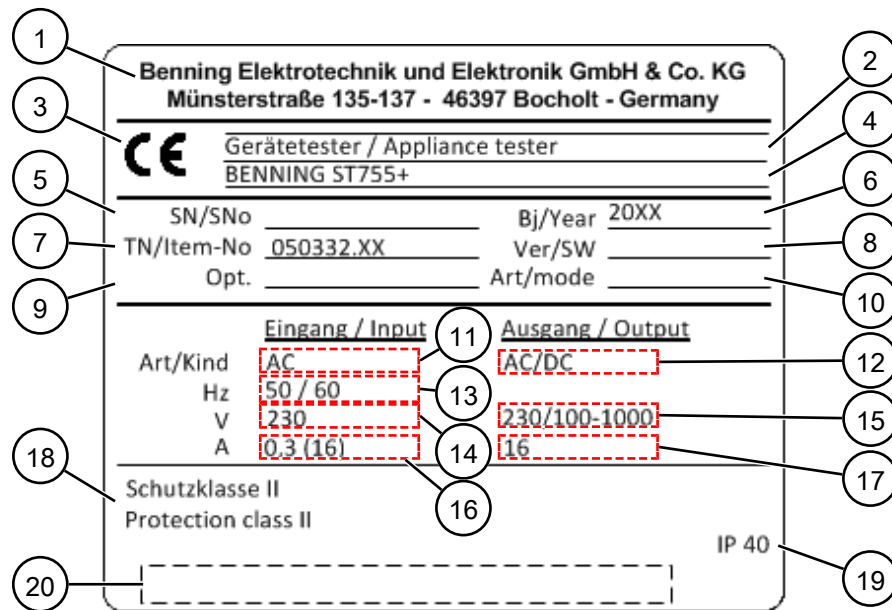

Figure 2: Type plate (exemplary)

1	Manufacturer or sales partner	2	Product type / product classification
3	CE marking	4	Series
5	Serial number	6	Year of manufacture
7	Item number	8	Software version
9	Option number	10	Operating mode
11	Type of current at the input	12	Type of current at the output
13	Nominal input frequency [Hz]	14	Nominal input voltage [V]
15	Nominal output voltage [V]	16	Nominal input current [A]
17	Nominal output current [A]	18	Protection class
19	Protection category (with device being open)	20	Barcode

## 5.3 Screen setup

The screen is divided into different sections. The display of these sections may change during operation.

### Display

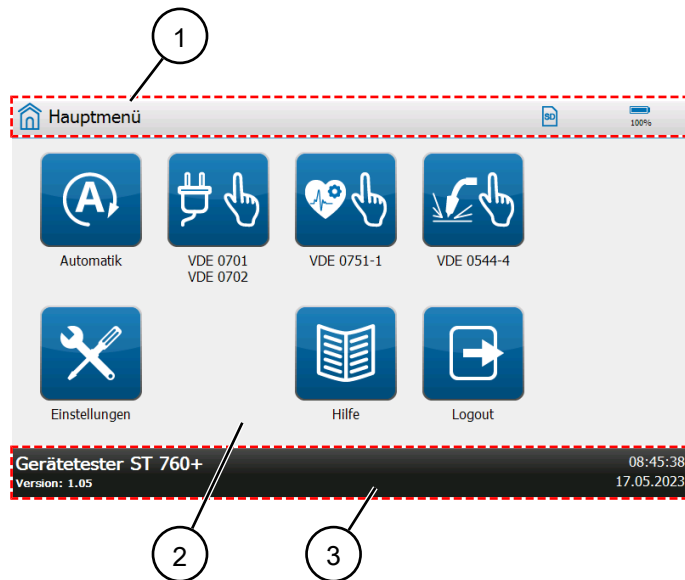

Figure 3: Screen layout

1	Header	2	Information screen
3	Footer		

### Header

Various pieces of information and buttons are displayed in the header. Header content:

#### General symbols and buttons:

Symbol	Designation	Description
	Battery	Indicates the state of charge of the battery.
	Memory card	Indicates an inserted SD card.
	Network connection	Indicates an existing network connection (LAN, WLAN).
	USB	Indicates an existing USB connection.
	Bluetooth	Indicates an existing Bluetooth® connection.

Symbol	Designation	Description
	Menu	Displayed in the “Automatic” menu. Tapping the button opens the main menu of the “Smart menu”.
-	Menu designation	The menu designation of the currently opened menu is displayed on the left in the header.

Table 3: General symbols and buttons in the header

**Symbols for test sample and protection class:**







Symbol	Designation	Description
	Class I	Protection class 1
	Class II	Protection class 2
	Class III	Protection class 3
	-	Test sample acc. to VDE 0701/ 0702
	-	Test sample acc. to VDE 0751-1
	-	Test sample acc. to VDE 0544-4

Table 4: Symbols for test sample and protection class in the header

**Footer**

Various pieces of information and buttons are displayed in the footer. Footer content:

- Date and time
- Buttons for operation [▶ page 28]
- Version number (GUI)
- Device type



## 5.4 Menu structure

### Menu structure – Main menu

Main menu	
	Automatic testing
	VDE 0701-0702
	Devices with PE (Class I)
	Devices without PE (Class II)
	SELV (Class III)
	Reference to Settings & Help
	VDE 0751-1
	Devices with PE (Class I)
	Devices without PE (Class II)
	Reference to Settings & Help
	VDE 0544-4 / EN 60974-4
	Devices with PE (Class I)
	Devices without PE (Class II)
	Reference to Settings & Help
	Settings [▶ page 26]
	Help
	Help texts
	Logout

Table 5: Menu structure – Main menu

**Menu structure – Settings**

Settings	
System settings	
System data	
Device data	
Network	
Information	
Host name	
LAN IPv4	
WLAN IPv4	
WLAN networks	
Remote control	
Information	
Bluetooth	
Database	
User administration	
Expert settings	
Customer-specific limits	
Customer-specific visual inspection	
Customer-specific test procedures	
Update (GUI, firmware)	
Via USB stick	
Via network	
Factory settings	
Templates	
Test procedures	
Visual inspection	
Device templates	
Balance / calibration	
ZERO balance	
Cable calibration	
Probe calibration	
Display, time, language	
Time	
Date	
Language	
Brightness	
Touch calibration	

Table 6: Menu structure – Settings

## 6 General operation

You can operate the device via the 7" touch display. By tapping buttons you can navigate through the menu, set functions and parameters and carry out measurements. This chapter describes the basic operation of the device.

### 6.1 Switching the device ON/OFF

Plug the mains connection cable into a shock-proof socket (230 V, 50 Hz, 16 A). To switch the device on, set the mains switch to position "I". After the start sequence, the device carries out a self-test and shows the "Registration / login" [▶ page 28] screen.

### 6.2 Operating elements









Setting options	Example	Description
Button		Tap the button to open a menu.
Buttons in the footer (e. g.: "New")		Tap the button to open a screen with further setting options.
Input line		Input window for text input. Tap the input window to display the soft keyboard.
Error message	-	Will be displayed in the event of an error. Follow the instructions.
Soft keyboard	-	To enter text, a soft keyboard appears on the display. Tap the displayed soft keys to make your entries.
		Tap the "Enter" button to confirm the input. The soft keyboard is hidden automatically.
		Tap the keyboard icon to show or hide the soft keyboard. Hiding the soft keyboard terminates the input.
	  	Writing upper and lower case letters: <ul style="list-style-type: none"> <li>• Lower case</li> <li>• Beginning of word with upper case</li> <li>• Permanently upper case (tap and hold the soft key for 2 seconds)</li> </ul>
Button (e. g. probe calibration)		Starts a test or measurement.

Table 7: Operating the screen

## 6.3 Login

The following procedure describes how to log on to the device [▶ page 64].

### Procedure

1. Switch on the device [▶ page 27].  
After the start sequence, the device shows the “Registration / login” screen.
2. Select a user. To do this, tap the “Name” input line.  
The “User” screen is displayed.
3. Select a user (e. g. admin or guest).  
You do not need any password to log in as a guest user. You will have limited access to the functions of the device.
4. Enter the password.  
Preconfigured default password of the admin user: Benning  
If the password has been entered incorrectly, the following message appears on the “Registration / login” screen: “Wrong name or password!” In this case, correct your entry and confirm the login again. If you have forgotten your password, you can have it recovered [▶ page 99].
5. Optionally: Enter an order number. The order number will appear in the later test report.
6. Confirm your entry. To do this, tap the “Log on” button.  
The main menu is displayed.  
To prevent unauthorised access, replace the preconfigured default password and create new users if necessary. [▶ page 64].

## 6.4 Buttons in the footer

Button	Description
Copy	Copies a parameter entry and opens a new screen to display the contents. On this screen, the copied parameter entries can be adjusted. This facilitates, for example, the creation of test sample templates (device templates).
Search	Searches for Bluetooth® connections.
Save	Saves the input.
Help	Opens the help menu.
Back	Returns to the previous menu. The input is cancelled.
OK	Confirms a selection or input.
Start	Starts the selected test or measurement.
New	Creates a new parameter entry (customer, department, test sample, etc.).
Delete	Deletes the selected parameter.
Update (WLAN networks)	Searches for new WLAN networks [▶ page 58].
Connect (WLAN networks)	Connects to the selected network.
Disconnect (WLAN networks)	Disconnects from the selected network.
All inactive (device properties)	Disables (OFF) all parameters in the list [▶ page 58].

Button	Description
All active (device properties)	Enables (ON) all parameters in the list.
Reset (device properties)	Enables (ON) all parameters. The settings are saved automatically.
Reset (test)	Deletes a faulty measured value during the ongoing test.
Check (database)	Checks the database for errors.
Rename	Opens an input window for assigning a new name.
Limits (test)	Opens the limit settings and allows the modification of limits for the active test [▶ page 60].
Save (limits)	Stores modified limits temporarily [▶ page 36].
Reset (limits)	Resets all temporarily changed customer-specific limits to the default limits (factory settings) [▶ page 36].
Overwrite (limits)	All changed limits are set permanently as new default limits [▶ page 36].
Test procedure	Opens the “Test procedure” screen where the test procedure can be adjusted individually.
Close	Closes the opened database.

Table 8: Buttons in the footer

## 6.5 Operating the list view

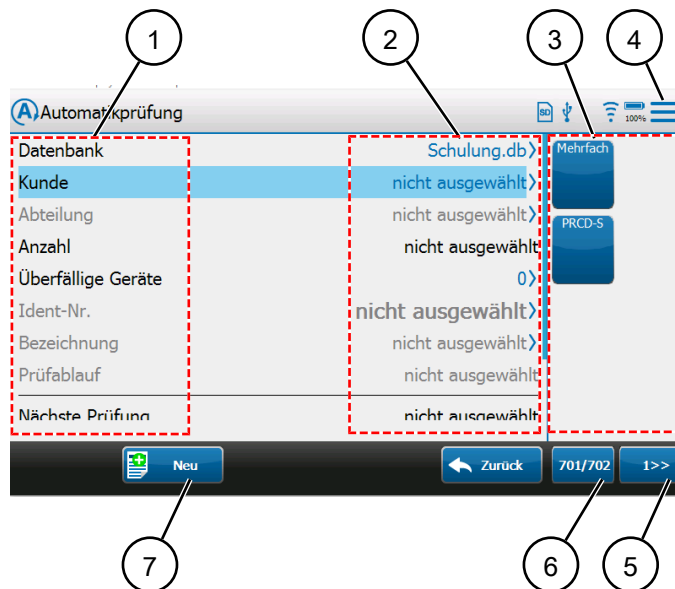

Figure 4: General operation

1	Parameters (left side of the list view)	2	Status messages/ selected parameter entry (right side of the list view)
3	Smart menu – Device templates (test sample templates)	4	Smart menu (main menu)
5	Smart menu – Page selection (exemplary)	6	Smart menu – Test standard selection (exemplary)
7	Button in the footer (exemplary)	8	-

## Operating options

Operation	Example	Description
Scrolling through lists	-	Swipe up or down on the left half of the list view to scroll through the list.
Selecting parameters	-	Tap the parameter in the left half of the line to select it (highlighted in blue). Further entries can be made using the buttons in the footer.
Selecting parameter entries	>	Tap the right half of the line to open a selection window with parameter entries (e. g. customer names, test sample templates ...).
Filling parameter entries	>	Tap the right half of the line to open an input window and the soft keyboard for adding new entries.
Enabling and disabling parameters		Tap the slider to enable (ON) or disable (OFF) the parameters. If the setting requires the authorisation of the "Admin" user or is not possible due to another setting, the slider is greyed out (light grey) in the given position and cannot be changed.

Table 9: Operating the list view

## Status messages

The status displays the last parameter entry created or selected.

If no parameter entry is selected, one of the following status messages will be displayed:

Status message	Description
"not selected"	The parameter has not yet been created or selected.
"(empty)"	If the department (empty) is selected, all the test samples that are not assigned to any department will be displayed.
"(display all)"	If the department (display all) is selected, all test samples will be displayed independently of their assignment to a department.
"Connecting"	A connection to the network is being established.
"Connected – waiting for IP"	The device is waiting for an IP address being assigned by DHCP.
"Connected"	The device has been successfully connected to the network and the connection is active.

Table 10: Status messages

## 6.6 Operating the test view

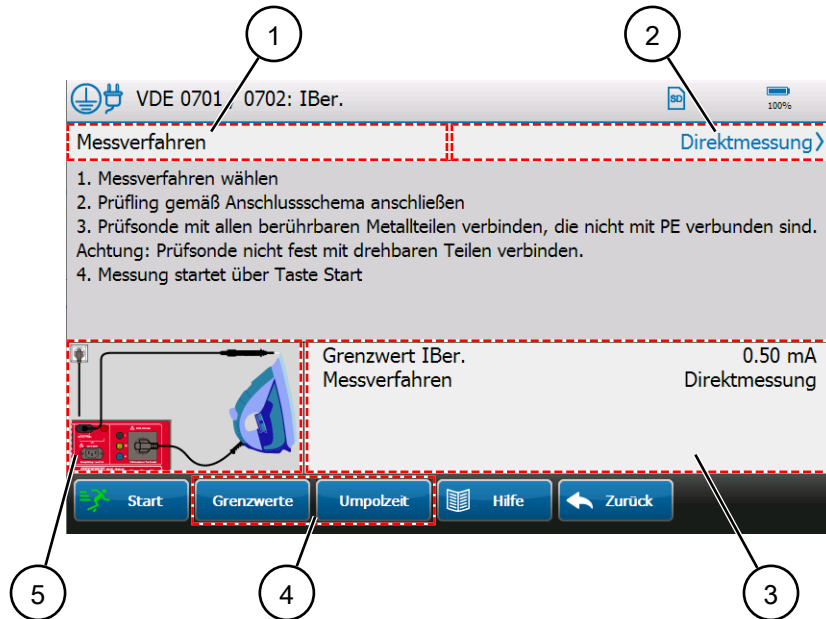

Figure 5: Test view

1	Selectable parameter	2	Selected parameter entry (Tap to open the selection window.)
3	Display area for measurement details	4	Buttons for measurement-specific settings for the duration of the test.
5	Connection diagram (Tap to enlarge the screen.)	6	-

### Operating the test view

Button	Description
Start	Starts the test.
Stop	Automatic test: The test is stopped. The "Automatic test" screen opens. Manual test: The individual test is completed. The intermediate view of measuring results is displayed.
Pause	The measurement is paused. Is used when changing the position of terminals or test probes to avoid incorrect measurement.
Next	Continues the paused measurement.
Reset	Deletes incorrect measured values (only works when the test is running). The test duration is reset.
Limits	"Limits" [▶ page 60] and "Polarity reversal time" [▶ page 40] can be changed for the duration of the test.
Polarity reversal time	



Button	Description
 	For reversing the polarity of the test voltage during manual individual tests.
Cable (On/Off)	<p>Is enabled for the detection of defects on cables / mains connection cables.</p> <p>ON = The protective conductor is continuously checked for cable breaks. For this test step, the "RPE test repetition" [▶ page 56] setting is temporarily switched off.</p> <p>OFF = The continuous check for cable breaks of the protective conductor is switched off. For this test step, the "RPE test repetition" setting remains switched on.</p>
Offset (On/Off)	Enables / disables the offset by means of a measuring adapter during the test. To do this, specify the internal resistance of the measuring adapter under: "Settings >System settings >RPE resist. test adapter"
Done	Completes the test and goes to the "Test result" test report.

Table 11: Test view buttons

### Eliminating measuring errors

If a measured value is outside the set limits, it will be displayed in red font. In this case, the test sample will not pass the test.

1. Establish a proper connection between the test probe and the contact point of the test sample.
2. Tap the "Reset" button while the measurement is active or running.

The maximum value will be overwritten by the currently measured value.

If the measured value is lower than the defined limit, the test is passed.

### Test report "Test result"

At the end of a test procedure, the test result is displayed in the form of a test report. Fill in the following information:

Setting options	Description
Device *Manual test	Select the test sample: Tap the right side of the "Change" line to select the test sample from the database or to create a new test sample.
Test type	Select the test type: <ul style="list-style-type: none"> <li>• Periodic testing (VDE 0702)</li> <li>• Test after modification (VDE 0701)</li> <li>• Test after repair (VDE 0701)</li> <li>• Receiving inspection (VDE 0702)</li> </ul>
Note	Add a comment regarding the test / test sample: Tap the right side of the "Change" line to open an input window for adding comments.

Table 12: "Test result" screen



6.7 Operating the Smart menu

Then, you can proceed as follows with the test reports:

Button	Description
Print	If a log printer is available, the "Test result" test report can be printed directly.
Discard	Deletes the "Test result" test report and finishes the test procedure.
Save	Saves the "Test result" test report in the database. You can read it out via your PC [▶ page 35].

Table 13: Proceeding with the test report

## 6.7 Operating the Smart menu

In the automatic testing function, you can find the "Smart menu" [▶ page 29]. In the Smart menu, use the "Device templates" (test sample templates) and the "Auto-ID" function to quickly create a new test sample with the subsequent ID. This speeds up the creation of new test samples.



Button	Description
Device template	Here, you can select from previously created test sample templates [▶ page 63].
Device template – Quick selection button 	Tap the quick selection button to create test samples and edit them as required. These test samples will be assigned to the selected database and the customer. If the "Auto-ID" function is enabled, the next free ID will be assigned to the test sample. If the "Auto-ID" [▶ page 56] function is not enabled, the "Device" screen will be displayed to enter the ID (test sample properties).  *Example of a quick selection button for a test sample of type "PRCD-AC"
Device data	Quick access to the device data [▶ page 58].
Favourites	Quick access to menus and manual measurements.
Auto-ID	Intended to specify the next free auto-ID. This might be necessary, for example, if a barcode roll with a new, consecutive (n+1) identification number shall be used.
Standards 	Select the test standard. (Filter function for displayed test sample templates)
Page selection 	"Scrolls" to the next page.

Table 14: Smart menu – Main menu

### Procedure – Creating a test sample

1. Select a database and a customer.
2. Create a test sample (device). To do this, go to the "Device templates" menu, tap the "Standards" button (note the page selection) and select the corresponding test sample template [▶ page 37] (quick selection button).  
If the "Auto-ID" [▶ page 56] function is not enabled, enter the desired ID.

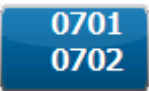
# 7 Functions

## 7.1 Database

The "Database" menu is intended to manage the following contents [▶ page 65]:

- Database names
- Customer data
- Department names
- Test sample data

The database structure is as follows:

Database (e. g. sample)	
Customer (e. g. sample company)	
Department (e. g. purchasing)	
Test sample (e. g. PC 1)	
Test sample (e. g. printer 1)	
Test sample (e. g. printer 2)	
Test sample (e. g. coffee machine 1)	
...	
Department (e. g. sales)	
Test sample (e. g. PC 1)	
Test sample (e. g. printer 1)	
...	
Customer (e. g. sample company 2)	
Department (e. g. engineering)	
Test sample (e. g. PC 1)	
Test sample (e. g. phone 1)	
...	
Department (e. g. workshop)	

Table 15: Database structure (exemplary)

### Database contents

Parameter	Description
Database	You can create multiple databases. The database name is assigned when a database is created. Afterwards, the database name can only be modified using the PC software (BENNING PC-WIN ST 750-760). It is not possible to edit measured values that have been stored.
Customer	You can create multiple customers for each database. The customer name is assigned when a customer is created and can still be modified afterwards.
Department	You can create multiple departments for each customer. The department name is assigned when a department is created and can still be modified afterwards. If the department "(empty)" is selected, all the test samples that are not assigned to any department will be displayed. If "(display all)" is selected, all test samples will be displayed independently of their assignment to a department.

## 7.2 Backup copies

Parameter	Description
Number	The number of test samples is displayed depending on the three parameters "Database", "Customer" and "Department".
ID no. / designation	These parameters are intended to manage test samples. The identification number and test sample designation ("device") are entered for the unique naming of test samples. If there are already test samples in the database, the parameters of the last test sample created are automatically used for entering a new test sample. The use of previous test sample parameters helps to quickly create identical test samples (extension cables, multiple sockets etc.).
Designation	If a test sample is selected, these parameters are automatically taken over from the test sample data ("Device" screen).
Test acc. to	
Protection class	
Test procedure	

Table 16: Database contents

## 7.2 Backup copies

You can copy your database as well as measured values to your PC for backup.

To do this, use the medium of the selected storage location (SD card, USB stick) or connect to the device with a USB cable and access the data.

### BENNING PC-Win ST 750-760

The logging software is intended to manage databases and enables the following functions:

- Create new databases
- Export databases
- Import existing databases
- Edit, merge, clean, repair, compress databases
- Control the print output
- Create customer-specific test procedures
- Create customer-specific visual inspections
- Subsequently edit existing test reports

### Backward compatibility

The ST 755+ / ST 760+ is backward compatible with the ST 755 / ST 760. If you also work with the ST 755 / ST 760, you can transfer the data to the ST 755+ / ST 760+.

### Forward compatibility

The data from the ST 750 can be converted into the database format of the ST 755 / ST 760 / ST 755+ / ST 760+ using the logging software.

## 7.3 User administration

The "User administration" menu is intended to manage the following user data and access rights [▶ page 64]:

- User name
- User role (admin, user)
- Company
- Postal code
- Place
- Password

The created users can be selected when logging on to the device.

### User roles

- Users with guest status (user role: user) do not have access to the user administration and expert settings of the device after login. You do not need any password to log in.
- Users with admin status (user role: admin) are granted access to all functions of the device after login. You have to enter a password to log in.

## 7.4 Expert settings

The "Expert Settings" menu is intended to manage the following data:

- Customer-specific limits
- Customer-specific test procedures
- Customer-specific visual inspection
- Templates (customer-specific test questions and test procedures can be managed via the "Templates" menu item)
- Reset to factory settings
- Updating the GUI (Graphical User Interface) and the firmware

The expert settings can be changed only by users with admin status.

### 7.4.1 Customer-specific limits

The "Customer-specific limits" [▶ page 60] menu is intended to manage limits for manual tests and customer-specific test procedures.

The following limits can be modified:

- $R_{PE}$  (protective conductor resistance, line length, line cross-section)
- $R_{Insu}$  (insulating resistance, testing voltage)
- Cable (cable specifications)
- $U_a$  (max. output voltage and open-circuit voltage of welding circuit)
- PRCD (tripping current, tripping time, contact voltage)
- $I_{Cont}$  (contact current values, differential current values)
- $I_{Leak}$  (protective conductor current values, leakage current values, patient leakage current values)
- Test times (definition of all test times for individual tests)

The preset limits correspond to the test specifications that have been applicable at the time of printing. Administration and definition of the customer-specific limits shall be at the discretion of the qualified electrician carrying out the work.

## Saving limits

The modified limits are stored temporarily (until the next restart of the device). The standard test procedures in the automatic measuring mode will not be changed. Newly created customer-specific test procedures receive the standard limits from the device, but not the temporarily changed limits.

## Resetting limits

All temporarily changed customer-specific limits are reset to the default limits (factory settings).

## Overwriting limits

All changed limits are set permanently as new default limits. The change applies after confirmation of the "Overwrite" button and affects all newly created customer-specific test procedures and all manual tests. The limits of the standard test procedures will not be changed.

## Automatic determination of limits

If test values are calculated from different limits, they are automatically determined by the device.

Example for  $R_{PE}$  acc. to VDE 0701 / 0702:

- The preset and admissible resistance value for a line length of 5 m and a cross-section of up to 1.5 mm<sup>2</sup> is 0.3 Ω.
- For each additional line length of 7.5 m, the admissible resistance value increases by 0.1 Ω each.
- The maximum admissible resistance value is 1.0 Ω.
- If you increase the line length to a value from >5 m to 12.5 m, the device automatically calculates the admissible resistance value.
- For cross-sections of more than 1.5 mm<sup>2</sup> and other cable lengths, the limit is calculated using the following equation:  $R = \rho * l/A + 0.1 \Omega$

## 7.4.2 Customer-specific visual inspection

The "Customer-specific visual inspection" [▶ page 61] menu is intended to manage individual test questions.

Here, you can create and save test questions. The saved test questions will be displayed on the "Questions" screen.

## 7.4.3 Customer-specific test procedures

You can access the created customer-specific test procedures via the automatic and manual tests of the device. Customer-specific test procedures can be assigned to both newly created test samples and already existing test samples [▶ page 61].

## 7.4.4 Customer-specific device templates

The "Customer-specific device templates" [▶ page 63] menu is intended to manage test sample templates.

Test sample templates speed up the creation of test samples. The test sample templates are displayed in the Smart menu [▶ page 33] of the “Device templates” screen. Here, up to 72 customer-specific test sample templates can be defined for each database. This means that up to 24 test sample templates can be created for each standard.

### 7.4.5 Customer-specific templates

The “Templates” [▶ page 38] menu area is intended to manage the following data:

- Customer-specific test procedures
- Customer-specific visual inspections
- Customer-specific device templates (test sample templates)

You can save customer-specific test sequences, visual inspections and test sample templates as cross-database templates on the device. In turn, you can copy these cross-database templates to specific databases.

### 7.4.6 Update

The "Update (GUI, firmware)" [▶ page 98] menu is intended to update the GUI and firmware of the device.

You can install updates [▶ page 98] via an existing network connection of the device or by using a USB stick (max. 32 GB) on the device.

If the device is connected to the Internet, it will automatically check for available updates. If an update is available, a query will appear on the display.

### 7.4.7 Factory settings

The "Factory settings" menu is intended to reset the device to its original settings. All system settings and changed limits will be lost. Databases are saved on the SD memory card and will be retained.

## 7.5 General test procedure

The device provides two testing options: The “Automatic test” and the “Manual test”. The following chapter provides a brief insight into both testing options and an overview of the terminology used.

## 7.5.1 Automatic testing

Automatic testing is primarily intended for periodic testing and tests after modification or repair of test sample entries that have already been created [▶ page 76].

Depending on the test standard and protection class of the test sample, the device offers preconfigured test procedures. When creating a test sample entry, a test procedure is assigned to the test sample. This test procedure will be used and run during automatic testing.

Four different steps are used to manage databases, customers, departments and test samples. The following functions can also be selected on the "Automatic test" screen:

Button	Database	Customer	Department	Test sample ID no. / Overdue devices
New	X	X	X	X
Change	-	X	X	X
Copy	-	X	-	X
Delete	-	-	-	-

Table 17: Functions of the "Automatic test"

### Overdue test samples

The device determines overdue test samples based on their last test date and the set test interval. To select a test sample that is overdue for testing, select a test sample using the "Overdue devices" line.

Test sample entries that are overdue for testing can be filtered out using the "Overdue devices" line. By default, the current date is entered as filter criterion. This setting shows you which test samples are already overdue on the date entered and need to be tested again. By tapping the "Overdue test samples" parameter, you can enter a future date that will show you test sample entries that need to be tested until this future date.

## 7.5.2 Manual testing

Manual testing is intended for tests of electrical devices after repair or modification and for periodic testing [▶ page 77]. In the event of a fault on the test sample, a test after repair (EN 50678, VDE 0701) must first be carried out before period testing (EN 50699, VDE 0702) may be performed.

The following manual tests according to specific standards are available:

- VDE 0701, VDE 0702 (electrical devices)
- VDE 0751-1 (medical electrical devices)
- VDE 0544-4 (power sources for arc welding)

The device provides the following individual tests:

- $R_{PE}$  (protective conductor resistance)
- $R_{Insu-1}$  (insulating resistance LN-PE)
- $R_{Insu-2}$  (insulating resistance sec.-PE)
- $R_{Insu-3}$  (insulating resistance LN-sec.)
- $R_{Insu-4}$  (insulating resistance LN-accessible parts without PE)
- $I_{PE}$  (protective conductor current)
- $I_{Cont}$  (contact current)
- $I_{Leak}$  (leakage current for medical electrical devices)
- $I_{PLeak}$  (patient leakage current)
- Funct. (functional test)
- Cable (continuity test)
- $U_a$  (output voltage)
- PRCD (portable residual current protection device)
- $U_{a\ weld.}$  (voltage welding circuit)
- $I_{Cont\ weld.}$  (contact current welding circuit)

Depending on the test standard and protection class of the test sample, the device provides preconfigured individual tests. Specification, selection and order of the individual tests are determined by the responsible qualified electrician.

## 7.5.3 Terminology used in test procedures

The device provides two testing options: The "Automatic test" and the "Manual test". The following chapter provides a brief insight into both testing options and an overview of the terminology used.

### Connection test

During the first measurement, the device checks whether a dangerous contact voltage or a short-circuit is present and whether a test sample is connected. If the test has been passed, the device proceeds with the visual inspection.

### Polarity reversal time

The polarity reversal time is the delay time for mains pole reversal. It is used for test samples with a delayed response characteristics, e. g. when testing devices with a defined start time.

Delay times from 0 to 60 000 ms are admissible.

The polarity reversal time remains active only for the duration of the test.



## Test time

The test time is the duration of an individual test.

By default, manual tests run without a time limit (test time = 0 seconds). The test person must decide on the basis of the currently displayed values whether the test can be completed or not.

By default, the test times of the automatic test procedures are set to 5 seconds each. If the test time for automatic testing is set to 'infinite' (0), the "Stop" button must be tapped to complete the test. In case of another setting, the test will be completed automatically after the test time has elapsed.

## Polarity reversal of the testing voltage

For manual individual tests that require a polarity reversal of the testing voltage, you can carry out the polarity reversal by tapping the buttons "L<->N" and "N<->L".

## Visual inspection

The device provides three different types of visual inspections:

- Standard visual inspection
- Advanced visual inspection
- Customer-specific visual inspection

A test sample may only be electrically tested if no serious defects have been detected during the visual inspection.

### **Standard visual inspection:**

The standard visual inspection includes the following questions, the result of which can be evaluated with "OK" or "Error":

- "Is the Type plate OK and is the test sample provided with all warnings?"
- "Carry out a visual inspection of housing, cables and connectors."

### **Advanced visual inspection:**

The advanced visual inspection includes 18 questions that can be shown or hidden as needed using the ON/OFF sliders before the visual inspection begins. The visual inspection is started manually by tapping the "Start visual inspection" button. The result of the visual inspection can be evaluated for all with "All OK", or for each question with "OK", "F" for error or "N.A." for not available.

### **Customer-specific visual inspection:**

The customer-specific visual inspection offers you the possibility to formulate customer-specific questions and checks. The customer-specific visual inspection is structured like the extended visual inspection.

## 7.6 Device information

In the "Information" menu, you can find all current device data as well as contact data of the Technical support [▶ page 12].

- Device
- Item number
- Serial number
- Firmware version
- GUI version
- Storage battery voltage/current
- Storage battery capacity
- Kernel version
- Technical support
  - Phone number
  - Fax number
  - E-mail
  - Website

## 7.7 Individual tests

### 7.7.1 Protective conductor resistance

EN 50678 (VDE 0701) EN 50699 (VDE 0702)			EN 62353 (VDE 0751-1)		EN 60974-4 (VDE 0544-4)	
Class I	Class II	Class III	Class I	Class II	Class I	Class II
X	-	-	X	-	X	-

Test samples with protective conductor must have a proper and safe connection to all accessible conductive parts that are connected to the protective connector and can be live in the event of a fault [▶ page 79].

The protective conductor resistance is composed of the following values:

- The resistance value between the connection point of the test sample up to all accessible conductive parts of the test sample that are connected to the protective conductor,
- The transition resistances of all terminal and plug connections,
- the resistances of all connected extension and device connecting cables.

To determine the protective conductor resistance, you can select various testing currents.

- Testing current: 0.6 A-AC or 10 A-AC
- Test frequency: 50 Hz

When exceeding the limit [▶ page 111], it has to be checked whether other limits have to be observed due to product standards or manufacturer specifications.

## 7.7.2 Insulating resistance

EN 50678 (VDE 0701) EN 50699 (VDE 0702)			EN 62353 (VDE 0751-1)		EN 60974-4 (VDE 0544-4)	
Class I	Class II	Class III	Class I	Class II	Class I	Class II
X	X	X	X (optional)	X (optional)	X	X

By means of this measurement, you can determine whether the insulation of the test sample has sufficiently high resistances. A high insulating resistance ensures that no fault currents can flow off [► page 80].

The insulating resistance is measured between the following points, depending on the test standard and protection class:

Test standard	Measuring points
R <sub>Insu-1</sub>	LN to PE and conductive accessible parts (Class I)
	LN to test body (Class II)
	Input to test body (Class III)
R <sub>Insu-2</sub>	Secondary side to PE and conductive accessible parts (Class I)
	Secondary side to test body (Class II)
	Output to test body (Class III)
R <sub>Insu-3</sub>	LN to secondary side (Class I), (Class II)
	Input to output (Class III)
R <sub>Insu-4</sub>	LN to conductive accessible parts without PE connection (Class I)

For information devices and components carrying SELV, testing of the insulating resistance may be dispensed with if damage to the test sample might occur as a result of the measurement.

According to VDE 0751-1, a measurement of the insulating resistance is only necessary for medical devices if it is considered to be appropriate and is not excluded by the manufacturer's specifications in the accompanying documents.

The testing current is limited to 1 mA for each testing voltage. Tap the "Limits" button to manually change the applied DC testing voltage in integers between 100 ... 500 V-DC (-0 % / +25 %) or 501 ... 1 000 V-DC (-12 % / +25 %).

The following testing voltages are preset in compliance with the test standards:

- 250 V-DC
- 500 V-DC
- 1 000 V-DC

Carry out the following additional tests for devices with a secondary output voltage (e. g. isolating transformers, chargers, converters, power supply units):

1. Insulating resistance measurement between secondary and primary side
2. Insulating resistance measurement between secondary side and the equipment body
3. Contact current measurements of the secondary voltage outputs (except for Class III)
4. Measurement of the open-circuit voltage / output voltage.

### 7.7.3 Protective conductor current

EN 50678 (VDE 0701) EN 50699 (VDE 0702)			EN 62353 (VDE 0751-1)		EN 60974-4 (VDE 0544-4)	
Class I	Class II	Class III	Class I	Class II	Class I	Class II
X	-	-	X	-	X	-

For test samples of protection class I, the protective conductor current is tested at mains voltage to check it for proper insulation capacity. This is to ensure that no leakage or fault current flows from the active components to earth and that there is no risk of a dangerous electric flow via accessible conductive components [▶ page 83].

### 7.7.4 Contact current

EN 50678 (VDE 0701) EN 50699 (VDE 0702)			EN 62353 (VDE 0751-1)		EN 60974-4 (VDE 0544-4)	
Class I	Class II	Class III	Class I	Class II	Class I	Class II
X	X	X (optional)	X	X	X	X

The contact current must be measured on every accessible conductive component without protective conductor connection [▶ page 84].

This is to ensure that there is no risk of a dangerous electric flow via accessible conductive components. Accessible conductive SELV / PELV jacks can optionally be scanned, provided that no damage to the test sample has to be expected.

For this purpose, the following measuring methods may be used:

- Direct current measuring method (direct measuring method)
- Differential current measuring method
- Alternative leakage current measuring method

### 7.7.5 Device leakage current (medical electrical devices)

EN 50678 (VDE 0701) EN 50699 (VDE 0702)			EN 62353 (VDE 0751-1)		EN 60974-4 (VDE 0544-4)	
Class I	Class II	Class III	Class I	Class II	Class I	Class II
-	-	-	X	X	-	-

The device leakage current corresponds to the sum of all leakage currents and is tested at mains voltage for medical devices of protection classes I and II to prove proper insulation capacity. This is to ensure that no leakage current flows from the active components, the housing or accessible conductive components to earth and that there is no risk of a dangerous electric flow via accessible conductive components [▶ page 86].

For this purpose, the following measuring methods may be used:

- Direct current measuring method (direct measuring method)
- Differential current measuring method
- Alternative leakage current measuring method

### 7.7.6 Patient leakage current (medical electrical devices)

EN 50678 (VDE 0701) EN 50699 (VDE 0702)			EN 62353 (VDE 0751-1)		EN 60974-4 (VDE 0544-4)	
Class I	Class II	Class III	Class I	Class II	Class I	Class II
-	-	-	X	X	-	-

The patient leakage current is the current that flows from active applied parts via the patient to the PE conductor (earth). It is tested at mains voltage for medical devices of protection classes I and II to prove proper insulation capacity. This is to ensure that no leakage current flows from the active applied parts to earth and that there is no risk of a dangerous electric flow for the patient [▶ page 88].

For this purpose, the following measuring methods may be used:

- Direct current measuring method (direct measuring method)
- Alternative leakage current measuring method

### 7.7.7 Functional test

EN 50678 (VDE 0701) EN 50699 (VDE 0702)			EN 62353 (VDE 0751-1)		EN 60974-4 (VDE 0544-4)	
Class I	Class II	Class III	Class I	Class II	Class I	Class II
X	X	-	X	X	X	X

The functional test is intended for the final verification of electrical safety and is an obligatory part of the test standards to be considered [▶ page 90]:

- EN 50678 (VDE 0701)
- EN 50699 (VDE 0702)
- EN 62353 (VDE 0751-1)
- EN 60974-4 (VDE 0544-4)

Non-electrical functions, e. g. cutting, lifting or turning, must be checked at a lower level.

The functional test includes the following for all single-phase test samples:

- Input voltage
- Input current
- Effective power
- Apparent power

Moreover, depending on the test standard and protection class, the corresponding leakage current is measured.

Test standard	Protection class	Leakage current
EN 50699 (VDE 0701) EN 50699 (VDE 0702) EN 60974-4 (VDE 0544-4)	I	$I_{PE}$
EN 50699 (VDE 0701) EN 50699 (VDE 0702) EN 60974-4 (VDE 0544-4)	II	$I_{Cont}$
EN 62353 (VDE 0751-1)	I and II	$I_{Leak}$

Table 18: Leakage current measurement (test standard and protection class)

The functional test of three-phase devices can be carried out using the BENNING MA 2-16 / MA 4 measuring adapter. Input voltage, input current as well as effective and apparent power cannot be measured. If necessary, performance data of the measuring adapter are displayed, but not those of the test sample.

for complete functional testing of medical electrical (ME) devices or systems, additional measuring and testing devices may be required. e. g. infusion pump testers, defibrillator testers or patient simulators.

For this purpose, the following measuring methods may be used:

- Differential current measuring method
- Direct current measuring method (direct measuring method)

### 7.7.8 Cable continuity test

EN 50678 (VDE 0701) EN 50699 (VDE 0702)			EN 62353 (VDE 0751-1)		EN 60974-4 (VDE 0544-4)	
Class I	Class II	Class III	Class I	Class II	Class I	Class II
X	X	-	X	X	X	X

The cable continuity test is intended for measuring the line resistance and is used e. g. for connecting cables, extension cables and cable reels [▶ page 91].

The following limits can be set:

- Line length [m] [▶ page 37]
- Line cross-section [mm<sup>2</sup>]
- Number of conductors (max. for single-phase test samples)
- R line per conductor [Ω]

The test frequency is 50 Hz.

### 7.7.9 Safety extra-low voltage

EN 50678 (VDE 0701) EN 50699 (VDE 0702)			EN 62353 (VDE 0751-1)		EN 60974-4 (VDE 0544-4)	
Class I	Class II	Class III	Class I	Class II	Class I	Class II
X	X	X	-	-	-	-

The safety extra-low voltage is measured to check for compliance with the specifications regarding the rated voltage of test samples with SELV / PELV voltages [▶ page 92].

- SELV (safety extra-low voltage)  
In case of SELV, the conductors of the extra-low voltage side and the body of the test sample are insulated and not connected to a protective conductor.
- PELV (protective extra-low voltage)  
In case of PELV, the conductors of the extra-low voltage side and the body of the test sample are earthed and connected with a protective conductor.

The test socket is supplied with mains voltage. Exception: Test samples of protection class III.

### 7.7.10 Voltage of the welding circuit

EN 50678 (VDE 0701) EN 50699 (VDE 0702)			EN 62353 (VDE 0751-1)		EN 60974-4 (VDE 0544-4)	
Class I	Class II	Class III	Class I	Class II	Class I	Class II
-	-	-	-	-	X	X

The voltage of the welding circuit (open-circuit voltage) is tested to check for compliance with the specifications regarding the rated voltages of test samples according to VDE 0544-4 [▶ page 93].

7.7 Individual tests

The device uses a digital potentiometer to realise the load of the welding device. The load starts as soon as at least half of the limit of the welding voltage has been reached. The load duration is 3 seconds.

The device measures the AC or DC welding voltage, the peak value of the welding voltage and the welding current between the two poles.

### 7.7.11 Contact current of the welding circuit

EN 50678 (VDE 0701) EN 50699 (VDE 0702)			EN 62353 (VDE 0751-1)		EN 60974-4 (VDE 0544-4)	
Class I	Class II	Class III	Class I	Class II	Class I	Class II
-	-	-	-	-	X	X

The contact current of the welding circuit is tested to check for compliance with the rated values of devices according to VDE 0544-4 [▶ page 94].

For this purpose, the following measuring methods may be used:

- Direct current measuring method (direct measuring method)
- Differential current measuring method
- Alternative leakage current measuring method

### 7.7.12 PRCD

EN 50678 (VDE 0701) EN 50699 (VDE 0702)			EN 62353 (VDE 0751-1)		EN 60974-4 (VDE 0544-4)	
Class I	Class II	Class III	Class I	Class II	Class I	Class II
X	-	-	-	-	-	-

A portable residual current protection device (PRCD) provides protection against hazardous body currents in the downstream circuit in case of direct contact. The rated value for the tripping fault current is max. 30 mA [▶ page 95].

The device provides an automatic test procedure [▶ page 104] for each PRCD type. The PRCD test includes the following tests and measurements:

PRCD type	A	F	B	B+	K	S	S+	AC	2-pin	3-pin
Tripping type	AC / pulsating direct currents		DC / universal current-sensitive		AC					
Tests										
Tripping current at 0° and 180°	X	X	X	X	X	X	X	X	X	X
	X	X	X	X	X	X	X	X	X	X
Tripping times										
V <sub>Cont</sub>	X	X	X	X	X	X	X	X	X	X
Tapping the TRIP key	X	X	X	X	X	X	X	X	X	X
Interrupting the L conductor					X	X	X		X	X
Interrupting the N conductor					X	X	X		X	X
Interrupting the PE conductor					X	X	X			X

$V_{\text{Test probe}}$						X	X			
Additional measurements										
$R_{\text{PE}}$	X	X	X	X		X	X	X	X	
$R_{\text{Insu-1}}$	X	X	X	X	X	X	X	X	X	X
$R_{\text{Insu-2}}$										
$I_{\text{PE}}$	X	X	X	X	X	X	X	X	X	X
$I_{\text{Cont}}$						X				

Table 19: PRCD tests

The PRCD cannot be switched on without mains voltage due to undervoltage tripping.

PRCDs of type AC only detect pure sinusoidal currents and are therefore no longer approved in Germany according to VDE 0100-530. The contact current measurement of the PRCDs is carried out with a testing voltage of 230 V-AC and a testing current up to a maximum of 90  $\mu\text{A}$ .

### 7.7.13 Power distributors

EN 50678 (VDE 0701) EN 50699 (VDE 0702)			EN 62353 (VDE 0751-1)		EN 60974-4 (VDE 0544-4)	
Class I	Class II	Class III	Class I	Class II	Class I	Class II
X	X	-	-	-	-	-

A portable power distributor is intended for power supply at different locations and often includes an RCD (residual current protection device) and MCB (line safety switch).

The test procedures 19 and 20 available in the device include the necessary test steps that apply to a large number of commercially available power distributors.

Please note that the admissible limits and test steps of the test procedures available in the device might be different from the necessary limits and test steps of the switches used in the power distributor (RCD, MCB,...).

For testing, you can proceed as follows:

- Automatic test using an existing test procedure [▶ page 39]  
(test procedure 19 or 20; depending on the RCD installed in the test sample)
- Automatic test using a customer-specific test procedure
- Manual test including all necessary individual tests [▶ page 77].

## 7.8 Remote control

The remote control function mirrors the user interface of the device to an external end device (e. g. smartphone, tablet or PC) and allows the device to be controlled via the end device used. This function supports training consultants or qualified electricians in instructing trainees on the functional scope of the device.

The device can be controlled remotely using the following options:

- Remotely controlling the device via WLAN using a smartphone or tablet [▶ page 119]
- Remotely controlling the device via LAN using a PC [▶ page 118]

Please note that it is not possible to use the device via WLAN and LAN simultaneously.



## 7.9 Optional accessories

### 7.9.1 Three-phase testing with the BENNING MA 4

The BENNING MA 4 serves as a measuring adapter for testing three-phase test samples and supports the following measurements (active):

- Protective conductor resistance
- Insulating resistance
- Functional test and phase sequence test of cables
- Alternative leakage current measuring method
  - Protective conductor current, contact current, device leakage current, patient leakage current
- Differential current measuring method
  - Protective conductor current
  - Device leakage current
- Direct current measuring method
  - Contact current
  - Patient leakage current
- Functional test (power consumption and current consumption of the test sample cannot be determined)
- $U_a$  welding equipment (ST 760+)
- PRCD

The test procedures 17 - 22 [▶ page 102] included in the device represent automatic test procedures for using the BENNING MA 4.

When commissioning the measuring adapter, please observe the supplied operating manual as well as the instructions for the corresponding individual test.

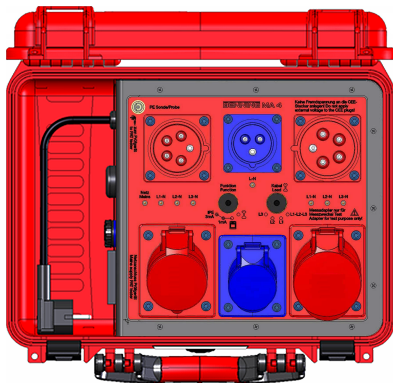

Figure 6: BENNING MA 4

### 7.9.2 Three-phase testing with the BENNING MA 3

The BENNING MA 3 serves as a measuring adapter for testing three-phase test samples and supports the following measurements (passive):

- Protective conductor resistance
- Insulating resistance
- Functional test and phase sequence test of cables
- Alternative leakage current
  - Protective conductor current, contact current, device leakage current, patient leakage current

The test procedures 21 and 22 [▶ page 102] included in the device represent automatic test procedures for using the BENNING MA 3.

When commissioning the measuring adapter, please observe the supplied operating manual as well as the instructions for the corresponding individual test.

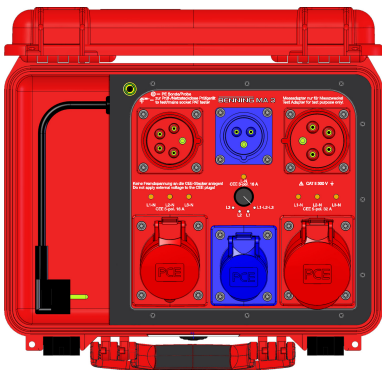

Figure 7: BENNING MA 3

### 7.9.3 Three-phase testing with the BENNING MA 2-16

The BENNING MA 2-16 serves as a measuring adapter for testing three-phase test samples and supports the following measurements (active):

- Cable continuity
- Insulating resistance
- Protective conductor current
- Contact current
- Functional test (power consumption and current consumption of the test sample cannot be determined)

The test procedures 17 - 20 and 22 [▶ page 102] included in the device represent automatic test procedures for using the BENNING MA 2-16.

When commissioning the measuring adapter, please observe the supplied operating manual as well as the instructions for the corresponding individual test.



Figure 8: BENNING MA 2-16

## 7.9.4 Single-phase and three-phase testing with the leakage current clamp

The leakage current clamps BENNING CM 9-1 and CM 9-2 are intended for partial testing of single-phase and three-phase test samples and support the following measurements:

- Protective conductor current (direct current and differential current measuring methods) Class I
- Contact current (differential current measuring method) Class II

There is no connection to the device. The measured leakage /fault current is entered manually in an input window of the device.

Measuring adapters facilitate testing with the leakage current clamp [▶ page 18].

The test procedures 12 and 13 [▶ page 102] included in the device represent automatic test procedures for using a leakage current clamp.

When commissioning the leakage current clamp, please observe the supplied operating manual as well as the instructions for the corresponding individual test.



Figure 9: BENNING CM 9-1 / BENNING CM 9-2

## 7.9.5 Barcode scanner (optional)

The optional barcode scanner serves as an optical recognition tool for the device and makes it easier to manage and identify the test samples. For this purpose, each test sample is provided with an adhesive barcode label and the barcode scanner is used to scan the barcode and transfer it to the database of the device. The available barcode scanners can be used via the Bluetooth® or USB interface.

The barcode scanner converts the scanned barcode into an input – similar to an input made via the keyboard – and transmits numbers, letters and special characters depending on the corresponding configuration.

The barcode scanners are configured by default for being used with the device.

The following barcode scanners are optionally available:

- USB barcode scanner
- Cordless barcode scanner (available from device software  $\geq 1.05$  or higher) with two operating modes
  - Cordless operation (integrated in the barcode reader, supports the Bluetooth® function integrated in the device)
  - 2.4 GHz wireless transmission (supplied USB dongle is required)

## Requirements

- Please observe the operating manual of the respective barcode scanner.
- The battery of the cordless barcode scanner is charged.
- The battery of the cordless barcode scanner is not in charging mode.

## Procedure – Putting the USB barcode scanner into operation

1. Switch on the device.
2. Connect the connecting cable of the barcode scanner to a USB-A port of the device.  
The status LED of the barcode scanner lights up and an acoustic signal is emitted. The barcode scanner is ready for operation.

## Procedure – Putting the wireless barcode scanner into operation (wireless)

1. Switch on the device.  
The barcode scanner must be configured to the “2.4 GHz wireless transmission” operating mode. The status LED of the barcode scanner is off, indicating that the barcode scanner is ready for radio transmission to the supplied USB dongle.
2. Plug the USB dongle of the barcode scanner into a USB-A port of the device.  
The barcode scanner is ready for operation.

## Procedure – Putting the cordless barcode scanner into operation (cordless)

1. Switch on the device.  
The barcode scanner must be configured to the “cordless” operating mode. The status LED of the barcode scanner changes to flashing mode and lights up in blue colour. The flashing mode of the barcode scanner indicates that the barcode scanner is ready for cordless connection to the device.
2. Establish a Bluetooth ® connection between the device and the barcode scanner [▶ page 59].  
The barcode scanner is ready for operation.  
If the connection fails, restart the device as well as the barcode scanner and repeat the commissioning.  
To disable the barcode scanner, press and hold the button of the barcode scanner for approx. 12 seconds. Press the button again to re-enable the barcode scanner.

## Procedure – Operating the barcode scanner

You can create and select test samples using the barcode scanner in the database as well as during the test procedure (automatic and manual tests according to VDE). Instead of entering the test sample identification number manually, the identification number or barcode is scanned using the barcode scanner by pressing a button. The identification number will be entered automatically.

## 7.9.6 RFID scanner (optional)

The multi-frequency RFID scanner and the optional RFID tags are accessories which have been factory-tested and adapted to the device. The RFID (Radio Frequency IDentification) procedure is intended for electronic identification of objects by means of radio transmission. An RFID system consists of two components: an RFID scanner and an RFID transponder (RFID tag). Each RFID tag is provided with a worldwide unique UID no. (unique identifier) which can be read by means of the RFID scanner and assigned to a test sample without any contact. For periodic inspection of electrical equipment, radio frequencies of 125 kHz (LF) and 13.56 MHz (HF) prevail. RFID technology offers the advantage that it can be applied continuously and reliably even in harsh industrial environments.

Please observe that metallic surfaces strongly influence the radio connection. The direct contact of an RFID tag to a metallic surface should be avoided. To transmit the UID no. of the RFID tag, the tag must be moved to the marked reception area of the RFID scanner.

### Requirements

- Please observe the operating manual of the respective RFID scanner.
- The RFID tag must not be placed on a metallic surface.

### Procedure – Putting the RFID scanner into operation

1. Switch on the device.
2. Connect the connecting cable of the RFID scanner to a USB-A port of the device.

The status LED of the RFID scanner lights up and an acoustic signal is emitted. The RFID scanner is ready for operation.

If the connection fails, restart the device as well as the RFID scanner and repeat the commissioning.

To disable the RFID scanner, press and hold the button of the RFID scanner for approx. 12 seconds. Press the button again to re-enable the RFID scanner.

### Procedure – Operating the RFID scanner

You can create and select test samples using the RFID scanner in the database as well as during the test procedure (automatic and manual tests according to VDE). Instead of entering the test sample identification number manually, the identification number is scanned using the RFID scanner. The identification number will be entered automatically.

## 7.9.7 Printer (optional)

The BENNING PT 2 is a Bluetooth® printer for printing test reports. You can connect the printer to the device via Bluetooth® and print test reports and labels directly.

### Requirements

- Please observe the operating manual of the printer.

### Procedure – Putting the printer into operation

1. Start the printer (insert batteries and a paper roll). To do this, follow the instructions given in the operating manual of the printer.
2. Switch on the device.
3. Establish a Bluetooth ® connection [▶ page 59] between the device and the printer.

### Procedure – Operating the printer

If the printer is connected to the device via Bluetooth® and is within range, you can tap the “Print” button on the “Test result” screen after having completed an automatic or manual test procedure to print out the test report on thermographic paper.

## 7.9.8 Keyboard (optional)

Two types of keyboards are available:

- Optional wireless keyboard

The optional wireless keyboard facilitates input and control on the device and offers wireless operation for working more flexibly in the vicinity of the device.

- Optional USB keyboard

The optional USB keyboard is protected against dust and splash water and is ideally suited for being used in industry due to its compact design.

### Requirements

- Please observe the operating manual the keyboard.

### Procedure – Putting the wireless keyboard into operation

1. Put the keyboard into operation (insert batteries). To do this, follow the instructions given in the operating manual of the wireless keyboard.
2. Switch on the device.
3. Plug the USB dongle of the wireless keyboard into a USB-A port of the device.
4. Press the "Fn" and "Esc" keys on the keyboard simultaneously.

The "Connect" status LED flashes to indicate that the keyboard is being connected. When the keyboard is connected, the "Connect" status LED remains off.

### Procedure – Putting the USB keyboard into operation

1. Put the keyboard into operation. To do this, follow the instructions given in the operating manual of the wireless keyboard.
2. Switch on the device.
3. Plug the USB dongle of the USB keyboard into a USB-A port of the device.

# 8 Configuration

## 8.1 Setting the system data

The "System settings" menu is intended to edit the basic settings of the device.

### Menu

"Settings > System settings > System data"

### Setting options

Parameter	Description
Auto-ID is enabled.	ON = The ID is automatically incremented [▶ page 33].
Auto-ID start	Start value that is incremented when a new customer is created or a customer has no devices. If test samples are already entered, the next free ID will be determined automatically.
RPE test repetition	ON = During the protective conductor resistance measurement, the device automatically detects whether a measuring point is contacted with the test probe. If the measured value is "OK", the device responds with an acoustic signal and the next measuring point can be contacted. If the connection is not OK, there will be two subsequent acoustic signals.
Test repetition	ON = The device asks whether another measuring point shall be contacted with the test probe. The query applies to: $R_{PE}$ (only if the $R_{PE}$ test repetition is switched off), $R_{Insu-2}$ , $R_{Insu-3}$ , $R_{Insu-4}$ , $I_{Cont}$ , $I_{Leak}$ , $I_{PLeak}$ , $I_{Cont weld}$ .
Notification sound	ON = Switches on the acoustic signal of the device.
Short-circuit test	ON = Enables the short-circuit test before starting a measurement. OFF = Disables the short-circuit test before starting a measurement.
IT network	ON = Allows the device to be used in an IT network.
Mains pole reversal	OFF = Disables mains pole reversal for leakage current measurements.
Standard test procedures	ON = Enables the standard test procedures. OFF = Hides the standard test procedures when the custom test procedures are enabled.
Custom test procedures	ON = Enables the custom test procedures. OFF = Hides the custom test procedures when the standard test procedures are enabled.
Polarity testing extension cable	ON = Enables the polarity reversal test for extension cables.



8.1 Setting the system data

Parameter	Description
Automatically search for Bluetooth® devices	ON = Enables the automatic search for BENNING Bluetooth® devices. It is possible to connect a Bluetooth® printer and a Bluetooth® 1D/2D barcode scanner. Only Bluetooth® devices of BT version ≤2.1 can be connected. Moreover, the Bluetooth® devices must not be protected by a password.
Bluetooth® active	ON = Enables the Bluetooth functionality of the device.
WLAN active	ON = Enables the WLAN functionality of the device.
Help graphic MA-4	ON = MA-4 is displayed.
RPE resist. test adapter	Here, the internal resistance of the measuring adapter in $\Omega$ is entered (setting for offset [▶ page 31] during the test).
Hide keyboard automatically	ON = The input keyboard is hidden.
Database directory	Selects the storage location of the database (SD card or USB stick).
Print test label	ON = Enables the printer (only possible in connection with the label and log printer PT 2).
Test label Configuration	The following parameters can be set if "Test label Configuration" is enabled (ON): <ul style="list-style-type: none"> <li>• Company name</li> <li>• Heading</li> <li>• Test date (ON/OFF)</li> <li>• Next inspection date (ON/OFF)</li> <li>• Print serial number (ON/OFF)</li> <li>• Print barcode (ON/OFF) (only possible with PT 2)</li> </ul>
Test label Dimensions	Setting the parameters for test labels (only necessary if the Benning standard roll is not used). The following parameters can be set if "Test label Dimensions" is enabled (ON): <ul style="list-style-type: none"> <li>• Print offset: value input</li> <li>• Label offset: value input</li> <li>• Label length: value input</li> <li>• Marking offset: value input</li> <li>• Marking length: value input</li> </ul> <p>The diagram illustrates a rectangular test label with a rounded top and bottom. The word 'TEXT' is centered within the label. Five dimension lines with arrows indicate the following parameters: 'Label Offset' (distance from the top edge of the label to the top edge of the text area), 'Print Offset' (distance from the top edge of the text area to the top edge of the text itself), 'Label Length' (total height of the label), 'Perforations Offset' (distance from the bottom edge of the label to the bottom edge of the text area), and 'Mark Length' (distance from the bottom edge of the text area to the bottom edge of the text itself). There are black rectangular marks at the top-right and bottom-right corners of the label.</p>

Table 20: Setting options for system data

## 8.2 Setting the device data

The "Device data" menu is intended to show and hide test sample properties.

### Menu

"Settings > System settings > Device data"

### Setting options

Use the slider (ON/OFF) to enable and disable the displayed test sample properties in the list [▶ page 66]. Enabled parameters are displayed and available for being selected. Disabled parameters are hidden.

## 8.3 Managing the network settings

The "Network" menu is intended to manage and display the network settings.

### Menu

"Settings > Network"

### Setting options

Changes in the network settings will only take effect after the device has been restarted.

Menu	Parameter	Description
Information	Host name DHCP Status IP address Subnet mask Standard gateway MAC address DNS accessibility Update server accessibility	Gives an overview of the current network configurations.
Host name	-	Changes the current host name (device name). The change of the host name only becomes effective after restarting the device.
LAN – IPv4 WLAN – IPv4	DHCP status	Enabled: The device is automatically integrated into an existing network.
	IP address	Can only be changed if DHCP is disabled.
	Subnet mask	
	Standard gateway	
WLAN networks	-	Manages the WLAN networks and connection establishment.
Remote control	-	Enables remote access from the end device or PC to the device.

Table 21: Network settings

## 8.3.1 Establishing a connection via WLAN

### Menu

“Settings > Network > WLAN networks“

### Procedure

1. Select a network.

If the desired network is not displayed, tap the “Update” button.

The signal strength of the WLAN network is specified in the corresponding line as a percentage value (100 % correspond to full signal strength).

2. Tap the “Connect” button to connect the device to the network. The “Password” window opens.
3. Enter your network password and confirm it with the “Enter” button.

### Result

The device has been successfully connected to the network. The access data are now stored in the device. When the status message “Not connected” is displayed, check if you are within range of the WLAN network and if the password is correct.

To disconnect the network connection, select the network and tap the “Disconnect” button. To delete the network connection, select the network and tap the “Delete” button.

## 8.3.2 Establishing a connection via Bluetooth

### Requirements

- Bluetooth® is enabled on the respective end device.

### Menu

“Settings > System settings > Bluetooth“

### Procedure

1. Search for available Bluetooth® devices.
2. Select your device and tap “Connect”.

If the connection fails, take the following corrective measures:

- “Disconnect” the Bluetooth® connection.
- “Delete” the Bluetooth® connection.
- “Search” again for the barcode scanner.
- “Connect” the barcode scanner again.

## 8.4 Managing the expert settings

### 8.4.1 Managing customer-specific limits

The “Customer-specific limits” menu is intended to manage limits for manual tests and customer-specific test procedures.

#### Requirements

- You are logged on to the device as a user with admin status.

#### Menu

“Settings > System settings > Customer-specific limits”

#### Procedure

1. Select the desired limit. To do this, tap the right of the line.  
A selection of test standards is displayed.
2. Select the corresponding standard. To do this, tap the right of the line.  
An input window opens.
3. Edit the limit and confirm your entries with the “Enter” button.
4. Save your entries. To do this, tap the “Save” button.

#### Result

The limits for the manual test are stored temporarily, until the device is restarted.

To reset the temporarily changed limits to the default values, tap the “Reset” button.

To permanently save the changed limits as new default limits for manual and customer-specific test procedures, tap the “Overwrite” [▶ page 28] button.

## 8.4.2 Creating a customer-specific visual inspection

The “Customer-specific visual inspection” menu is intended to manage individual test questions.

### Requirements

- You are logged on to the device as a user with admin status.

### Menu

“Settings > Expert settings > Customer-specific visual inspection”

### Setting options

- New (create)
- Change
- Copy
- Delete

### Result

Created test questions will be saved and displayed on the “Questions” screen.

## 8.4.3 Creating customer-specific test procedures

The “Customer-specific test procedures” menu is intended to create and manage test procedures for specific device types, deviating tests or special test states.

### Requirements

- You are logged on to the device as a user with admin status.

### Menu

“Settings > Expert settings > Customer-specific test procedures”

### Setting options

- New (create)
- Change
- Copy
- Delete

When you create or edit a test procedure, the “Test procedure” screen opens. The following settings can be made for the individual test procedure:

Parameter	Description
VDE	Select the test standard.
Protection class	Selects the protection class.
Visual inspection	Enables / disables the visual inspection.
Connection test	Enables /disables the connection test [▶ page 40].
RPE 600mA	Enables /disables the protective conductor resistance measurement with 600 mA.
RPE 10A	Enables /disables the protective conductor resistance measurement with 10 mA.
RInsu-1 / RInsu-IN	Enables / disables the insulating resistance measurement.
RInsu-2	
RInsu-3	
RInsu-4	
RInsu-OUT	
IPE	Disables the protective conductor current measurement or selects the measuring method.
ICont	Disables the contact current measurement or selects the measuring method.
Funct.	Selects the measuring method for the functional test.
Cable	Enables / disables the continuity test.
Ua	Enables / disables the output voltage measurement.
PRCD	Selects the PRCD type.
PRCD current intensity	Selects the tripping current of the PRCD.

Table 22: “Test procedure” screen

## 8.4.4 Managing customer-specific device templates (test sample templates)

The "Customer-specific device templates" menu is intended to manage test sample templates.

### Menu

"Settings > Expert settings > Customer-specific device templates"

### Procedure

1. Create a new template. To do this, select an empty line ("empty") and tap the "New" button. If there are already templates, you can select and edit them (change, copy, delete).
2. Fill in all relevant parameters for the test sample in the "Device" screen.
  - As "Designation", select an existing test sample as a template or create a new one.
3. Assign a quick selection button to the test sample. To do this, tap the "Select key" button in the Smart menu.
4. Select an empty quick selection button ("empty").
5. Fill in all relevant parameters for "Key labelling:" and confirm your entries by tapping the "OK" button.

## 8.4.5 Managing templates

The "Templates" menu area is intended to manage the following settings:

- Customer-specific test procedures
- Customer-specific visual inspections
- Customer-specific device templates – test sample templates

### Requirements

- Templates (test procedures, visual inspections, test sample templates) have already been created.
- You are logged on to the device as a user with admin status.

### Menu

"Settings > Expert settings > Templates > Test procedures / Visual inspection / Device templates"

## Operating principle

If you have selected a template type (test procedures, visual inspections or device templates), you will see the database-specific (test sample) templates on the left side of the screen and the cross-database (test sample) templates on the right side of the screen.

Buttons	Description
Change	Opens an input window for entering / editing the name.
Copy → ←	Copies a duplicate of the selected template to the respective "other side": <ul style="list-style-type: none"> <li>• Into the cross-database templates (storage on device)</li> <li>• Into the database-specific templates (storage in customer database)</li> </ul>
Delete	Deletes the selected template.
Copy all	Copies all templates to the respective "other side". Existing templates are overwritten if desired.

Table 23: How to manage templates

## Procedure – Using “Copy” as an example

1. Select a test standard.
2. Select a database.
  - If you want to copy a template from a database to the cross-database templates, select an entry on the left side of the screen and tap “Copy”.
  - If you want to copy a template from the cross-database templates to a database, select an entry on the right side of the screen and tap “Copy”.

# 8.5 Managing a user

The "User administration" menu is intended to manage user data and access rights.

## Requirements

- You are logged on to the device as a user with admin status.

## Menu

“Settings > User administration”

## Setting options

- New (create)
- Change
- Copy
- Delete



## 8.6 Managing a database

The "Database" menu is intended to manage the following contents:

- Database names
- Customer data
- Department names
- Test sample data

### Menu

"Settings > Database"

### Setting options

Button	Database	Customer	Department	Test sample / ID no.
New	X	X	X	X
Change	-	X	X	X
Copy	-	X	-	X
Delete	-	X	X	X

Table 24: Functions of the "Database administration"

### 8.6.1 Creating ("New") and selecting e. g. a database

#### Procedure – Creating a database

1. Select the "Database" parameter. To do this, tap the "Database" line on the left.
2. Create a new database. To do this, tap the "New" button in the footer.  
The input window "Database name" opens.
3. Enter the desired database name and confirm it with the "Enter" button.

When the database is created, it will be selected automatically. This is displayed in the status display of the database.

#### Procedure – Selecting a database

1. Open the selection window with the databases already created. To do this, tap the line on the right.
2. Select the desired database. To do this, tap the line and confirm by tapping the "OK" button.  
The database now is selected. This is displayed in the status display of the database.

## 8.6.2 Managing test samples

The test samples are managed via the “ID no.” parameter. The identification number and test sample designation (“device”) are entered for the unique naming of test samples.

Test samples can be managed in the following areas:

- Database
- Automatic testing
- Manual test acc. to VDE... (after completion of the test in the “Test result” test report under “Device”)

### Procedure – Creating a test sample

1. Select or create a database [▶ page 65].
2. Select or create a customer.
3. Select or create a department, if necessary (not mandatory).
4. Create a test sample. To do this, tap the “ID no.” line on the left.  
The input window “Device ID” opens.
5. Enter the desired ID manually or scan it using the barcode scanner or RFID scanner.  
The “Devices” screen is displayed.
6. Complete the data of the test sample and save it.

### Setting options

Parameter	Description
ID no. (mandatory)	Here, the identification number and test sample designation are entered for the unique naming of test samples. It is possible to enter a combination of text and numbers.  There are the following options for input: <ul style="list-style-type: none"> <li>• Manual input</li> <li>• Reading a barcode with the barcode scanner [▶ page 51]</li> <li>• Reading an RFID tag with the RFID scanner [▶ page 53]</li> </ul>
Designation	
Manufacturer	Enter or select the parameter.
Serial number	
Type	
Model	
Department	
Test acc. to	Select the test standard.
Protection class	Select the protection class of the test sample.
Test procedure (mandatory)	Select the test procedure.
Limits (administrator)	Limits are specified in the test procedure.
Visual inspection	Select the visual inspection [▶ page 41]: <ul style="list-style-type: none"> <li>• Standard visual inspection</li> <li>• Advanced visual inspection</li> <li>• Customer-specific visual inspection</li> </ul>
Test interval	Specify the test interval in months.

Parameter	Description
Next test	The next test date is displayed.
No. of conductors	Enter or select the parameter.
Line length (m)	
Line cross-section (mm <sup>2</sup> )	
P nom. (kW)	
Private property	The test sample is private property. Use the ON/OFF slider to enable or disable the setting.
Note	Add additional comments on the test sample.
Out of operation	The test sample is out of operation. Use the ON/OFF slider to enable or disable the setting.

Table 25: “Devices” screen

Use the “Test procedure” button to customise the test procedure of the test sample [▶ page 62].

## Procedure – Selecting a test sample

- To do this, tap the right of the “ID no.” line.  
An input window opens.
- Enter the desired ID no. of the test sample or scan it using the barcode scanner or RFID scanner.
- Confirm your entries with the “Enter” button.
- Confirm by tapping the “OK” button.  
The selected test sample is displayed in the status message.

### 8.6.2.1 “Change”, “Copy” and “Delete” using the test sample as an example

#### Requirements

- A test sample entry already exists.
- A test sample entry is already selected.

#### Procedure – “Change”

- Select the “ID no.” line. To do this, tap the line on the left of the list.
- Tap the “Change” button in the footer.  
The “Device” screen is displayed.
- Select the parameter (e. g. manufacturer) you want to change. To do this, tap the line on the right.  
An input window opens.
- Enter the desired parameter entry or select one of the existing entries and confirm it with the “Enter” button.
- Save the change. To do this, tap the “Save” button.  
The change of the test sample is stored in the database.

**Procedure – “Copy”**

1. Select the “ID no.” line. To do this, tap the line on the left of the list.
2. Tap the “Copy” button in the footer.  
The “Device” screen is displayed.
3. Select the “ID no.” parameter. To do this, tap the line on the right.  
An input window opens.
4. Enter the desired identification number and confirm it with the “Enter” button.
5. Adjust other parameters if desired.
6. Save the change. To do this, tap the “Save” button.  
A new test sample is stored in the database.

**Procedure – “Delete”**

1. Select the “ID no.” line. To do this, tap the line on the left of the list.
2. Tap the “Delete” button in the footer.  
The query “Do you really want to delete the device ...?” is displayed.
3. Confirm the query.  
The test sample is deleted from the database.

## 8.7 Zero balance, cable and probe calibration

Calibrate the device during initial commissioning using the internal calibration.

During the probe calibration, the transition resistances in the device including the cable of the connected probe are calibrated. You can change between a probe of 2 m and a probe of 5 m without having to calibrate again.

If you use a 1-pin probe, place a bridge between the “Sonde / Probe” jacks “+” and “-”.

### Requirements

- Please observe the requirements for measuring [▶ page 71].
- Approved safety measuring lines
- The test sample is disconnected from the mains.
- The test sample is connected according to the connection diagram.

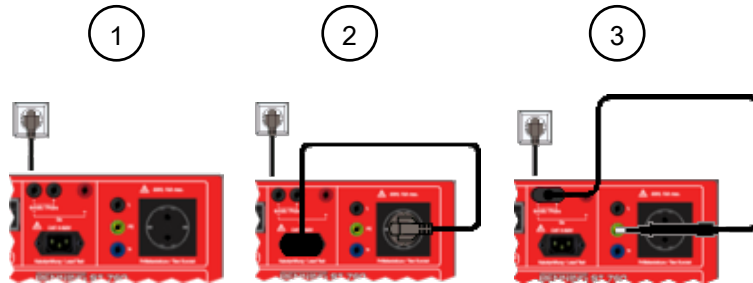

Figure 10: Balance / calibration

1	ZERO balance
2	Cable calibration
3	Probe calibration

### Menu

“Settings > Balance / calibration”

### Procedure

1. Start the desired balance / calibration.
2. Follow the instructions on the display.

### Result

Control display	Description
	The calibration / balance was successful.
	The calibration / balance has failed. Check the plug connections as well as the steps you have taken and start the test again.

## 8.8 Setting the display, time and language

### Setting options

Menu	Description
Time	Setting the time <ul style="list-style-type: none"> <li>• Left column: hours</li> <li>• Right column: minutes</li> </ul>
Date	Setting the date <ul style="list-style-type: none"> <li>• Left column: day</li> <li>• Middle column: month</li> <li>• Right column: year</li> </ul>
Language	Setting the language <ul style="list-style-type: none"> <li>• German</li> <li>• English</li> <li>• French</li> <li>• Dutch</li> </ul>
Brightness	Set the brightness of the display from 0 to 100 %. Move the yellow bar or enter a percentage value in the input field to set the display brightness. The setting is saved automatically when exiting the menu. Tap the "Reset" button to set the display brightness to the default setting of 25 %.
Touch calibration	Calibrate the touch display. <ol style="list-style-type: none"> <li>1. Start the calibration.</li> <li>2. Tap as precisely as possible in the center of the displayed cross.</li> <li>3. Repeat the process until no cross is displayed.</li> <li>4. Finish the process by tapping the display again. The following query opens: "Do you want to save the values?"</li> <li>5. If you confirm the query with "Yes", the calibration is accepted and the device will be restarted.</li> </ol>

Table 26: Display, time and language

# 9 Testing

## 9.1 Requirements for tests and measurements

Please observe the following basic requirements for tests and measurements:

- During initial commissioning before carrying out the first test: Calibrate the device using the internal calibration (zero balance, cable and probe calibration) [► page 69].
- Only use approved safety measuring lines [► page 74].
- Disconnect any safety measuring lines not required for the respective test or measurement from the device.
- Please consider sources of interference that might be present. Strong sources of interference in the vicinity of the device might involve unstable readings and measuring errors.
- For carrying out the tests and measurements, please observe the associated measuring ranges and measuring accuracies stated in the chapter "Measuring ranges".
- Please observe the figures for the corresponding test setup.
- Please note that if the test is interrupted or paused, the testing voltage is still applied.
- Determine the necessary measuring points before starting the test.
- Follow the instructions on the display of the device.
- Make sure that you are familiar with the general operation of the device [► page 27].
- A test sample may only be electrically tested if no serious defects have been detected during the visual inspection.
- Please observe applicable regulations from the current VDE / EN standard.
- Please observe the manufacturer's specifications in the accompanying documents of the test sample before starting a test as well as during the test.
- The cables of the test sample must be completely unreeled, e. g. in case of cable reels.
- For the testing of test samples with the warning "High leakage current!", the test must be carried out by qualified electricians only!
- Specification, selection and order of individual tests are determined by the responsible qualified electrician.
- The limits preset in the factory correspond to the normative specifications that have been applicable at the time of printing. Administration and definition of the customer-specific limits shall be at the discretion of the qualified electrician carrying out the work.
- For test samples with protective measures regarding the protective conductor: Test the test sample in all switch positions (test sample functions).
- Dangerous voltages might occur on the test sample during insulating resistance measurement ( $R_{\text{insu}}$ ) or when using the alternative leakage current measuring method.
- For device protection and for functional testing, the test voltages are monitored. In case of a fault, an error will be indicated on the display. Measurement will be interrupted. In case of a fault current of  $\geq 25$  mA, the device will be switched off within a period of 100 ms to 200 ms.
- Only carry out PRCD tests without load.
- In order to detect short-circuits and body contacts occurring behind the switch-on elements (e. g. switch, thermostat, relay) of the test sample, the test sample must be switched on.
- The jacks "L", "N" and "PE" are connected to the test socket. If mains voltage is applied to the test socket, the connection will be disconnected.
- Tap the "Pause" button to interrupt the measurement. During the pause, the test socket remains live!

## Current measurements

- The test sample is secured and placed onto an insulated surface.
- The measuring circuit is closed. Otherwise, no current is measured and the test result will be incorrectly displayed as being positive.
- Please observe inductive and capacitive circuits.
- If accessible conductive components of different potentials are arranged in such a way that they all can be touched with one hand, the sum of their contact currents has to be regarded as the measured value.
- When used in an IT power supply network, leakage current measurement is only possible using the alternative leakage current measuring method.
- For information devices and components carrying SELV / PELV, testing of the contact current may be dispensed with if damage to the test sample might occur as a result of the measurement.
- Direct / differential current measuring method:
  - If the insulating resistance cannot or should not be measured, the protective conductor current or contact current must be measured using the direct current measuring method or differential current measuring method.
  - Measurement with both polarities (L<->N; N<->L)
  - For the direct and differential current measuring method, the test socket is supplied with mains voltage.
- Alternative leakage current measuring method:
  - The alternative leakage current measuring method is only valid if there are no mains voltage-dependent switching devices in the test sample.
  - The test sample has passed the insulating resistance test [▶ page 80].
  - Test with mains equivalent voltage (230 V-AC).
  - The test sample has passed the protective conductor resistance test [▶ page 79].
  - Test samples with capacitor circuits can cause higher leakage currents. Please check whether the measured leakage current values comply with the applicable limits.

## Resistance measurements

- Insulating resistance:
  - For information devices and components carrying SELV, testing of the insulating resistance may be dispensed with if damage to the test sample might occur as a result of the measurement.
  - In case of test samples which are connected to each other via fastenings or are galvanically isolated from each other or have a common protective conductor: Please test each component individually.
  - Test samples with electrically operated switching elements might, if necessary, prevent the testing voltage from being applied to all accessible conductive and active components. Please test such test samples at mains voltage and being particularly careful.
  - Test samples with magnetic, thermal or optical switching elements might prevent the testing voltage from being applied to all accessible conductive and active components. Please test such test samples with the contact of the switching element being closed.
  - If for test samples with heating elements and a power of  $P > 3.5 \text{ kW}$  the value falls below the limit, the test sample still shall be considered to be in proper condition as long as the limit for the protective conductor current is not exceeded.



### 9.1 Requirements for tests and measurements

- If, for insulating resistance measurement, not all parts are measured completely (e. g. if relays or semiconductor components impede the transmission of electricity), the alternative leakage current measuring method must not be applied. The direct current measuring method or the differential current measuring method is applied.
- If the insulating resistance measurement of devices with heating elements >3.5 kW has been terminated with a negative result, the alternative leakage current measuring method must not be applied. The direct current measuring method or the differential current measuring method is applied.
- Protective conductor resistance:
  - During the protective conductor measurement, move all movable individual parts of the protective conductor section.
  - For test samples with long connecting cables and a protective conductor resistance > 1  $\Omega$ , the operator of the test sample must be informed that the loop impedance of the circuit might become too high and that the test sample should be used with a residual current protection device (RCD).
  - If there is a significant change of the measured resistance value when the protective conductor is moved, it must be assumed that the protective conductor is not properly connected or damaged or that one of the terminal or plug connections has lost contact with the test sample.

### Functional test

- The test sample must only be tested for proper functioning after it has passed the safety test!
- For the direct and differential current measuring method, the test socket is supplied with mains voltage.
- Measurement with both polarities (L<->N; N<->L)
- For the direct current measuring method, the test sample is placed onto an insulated surface.
- Please prove, before carrying out the functional test and all tests for which the test sample is supplied with mains voltage and put into operation, that there are no short-circuits in the test sample within phases L1, L2, L3 and the neutral conductor N.
- Before starting the functional test, switch off the test sample at the device's own switch. Do not switch on the test sample until the corresponding query appears on the display of the device.
- In case of test samples which are connected to each other via fastenings or are galvanically isolated from each other or have a common protective conductor: Please test each component individually.

### Testing of welding equipment

- Please observe the ignition voltage of the welding equipment. Please test only welding devices with voltages <200 V-DC and <150 V-AC.
- The test socket is supplied with mains voltage.
- For TIG and plasma welding devices, the output voltage ( $U_a$  weld.) must not be measured with the device.
- To set the limits, please observe the information stated on the type plate of your welding device and the overview of specifications stated in the relevant standards.
- The device uses a digital potentiometer to realise the load of the welding device. The load starts as soon as at least half of the limit of the welding voltage has been reached. The load duration is 3 seconds.

## Testing of medical electrical (ME) devices

- The insulating resistance must be measured before applying the direct current measuring method for medical test samples of protection classes I and II.
- The  $I_{PLeak}$  test must only be carried out after the protective conductor resistance test and the insulating resistance test have been passed.
- When testing medical electrical devices and systems, consult a specialist who is familiar with the application of the test sample.
- Additional measuring and testing devices might be required for complete functional testing of medical electrical (ME) devices or systems.
- The patient leakage current is measured exclusively on the test sample and its applied parts. Do not carry out any measurements on the patient!
- Tests of medical electrical test samples with multiple applied parts: Connect them one after the other.
- Separate measurements of the patient leakage current of applied parts of type B must only be carried out if prescribed by the manufacturer.

## 9.2 Connecting the safety measuring lines

For certain tests and measurements, it is necessary to connect the safety measuring lines to the device.

### Requirements

- Please observe the requirements for measuring [▶ page 71].
- Safety measuring lines

The safety measuring lines must be approved for the device (e. g. safety measuring lines included in the scope of delivery) and be in a technically perfect and operationally safe condition.

  - Check the specifications regarding nominal voltage and nominal current.
  - Check the insulation of the safety measuring lines.
  - Check the safety measuring lines for continuity.
  - Replace defective safety measuring lines.
- Protective caps (depending on the overvoltage category)
- During tests and measurements, only touch the safety measuring lines in the area intended for your hands.



## ⚠ WARNING

### Dangerous voltage

Danger to life or serious injury is possible due to contact with high electric voltage in case of incorrect operation.

- Do not touch the bare measuring probe tips of the safety measuring lines or the bare contacts of the optional alligator clips. Only touch the safety measuring lines in the area intended for your hands.
- Please note that dangerous testing voltages might be present at the device during insulating resistance measurement. These might also be applied to the measuring circuit if safety measuring lines are contacted.
- Connect the safety measuring lines to the correspondingly marked measuring jacks of the device and check them for tight fit.
- Only use approved safety measuring lines.
- Attach the protective caps to the contact tips of the safety measuring lines (circuits of overvoltage category CAT III or IV).
- When disconnecting the measuring circuit, first remove the live safety measuring line (phase) and then the neutral safety measuring line from the measuring point.

## Procedure

Connect the safety measuring lines to the following jacks according to the respective individual test:

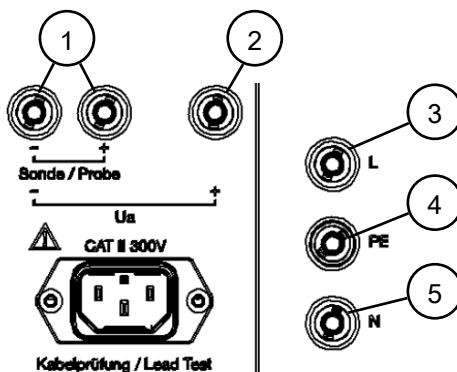

Figure 11: Device view – jacks

1	Black measuring jacks for the test probe	2	Red measuring jack for safety measuring line with probe tip for voltage measurement
3	Black "L" jack is connected to the "L" of the test socket (connection is disconnected when mains voltage is applied to the test socket)	4	Yellow-green "PE" jack for safety measuring line with probe tip for current and insulating resistance measurements
5	Blue "N" jack is connected to the "N" of the test socket (connection is disconnected when mains voltage is applied to the test socket)		

Make sure that all terminal and plug connections are in perfect contact with the accessible and conductive parts of the test sample.

## 9.3 Automatic testing

Automatic testing is primarily intended for periodic testing and tests after modification or repair of test sample entries that have already been created.

### Requirements

- Please observe the requirements for measuring [▶ page 71].
- Approved safety measuring lines

### Menu

Main menu > Automatic test

### Procedure

1. Select a database.  
If no database is available, create a new database.
2. Select a customer.  
If no customer is available, create a new customer.
3. Select a department.  
If no department is available, select "(display all)" or "(empty)" or create a new department.
4. Select a test sample (ID no. / Overdue devices)  
To select a test sample that is overdue for testing, select a test sample using the "Overdue devices" line.  
When you have selected all the parameters stated, the "Start" button will be displayed.
5. Start the automatic test and follow the instructions.  
If the connection test [▶ page 40] is successful, the "Visual inspection" screen will be displayed.
6. Carry out the visual inspection.
7. Evaluate the result of the visual inspection.
  - There are no defects:  
Confirm using the button "OK" or "All OK".  
If there are no serious defects, tap the "Start" button to complete the visual inspection and start the test procedure.
  - There are defects: Evaluate the defect with the "Error" button or for each negative result with the "F" button for 'fail' or "N.a." for 'not available'.  
If there are serious defects, stop the test. To do this, tap the "Done" button to go directly to the test report.
8. Carry out the test procedure [▶ page 31]. To do this, follow the instructions on the display and the instructions for the respective individual test [▶ page 79].  
After the test procedure is completed, the test report is displayed in the "Test result" screen.
9. Select the test type. To do this, scroll to the end of the test report and choose between periodic testing, test after modification, after repair or receiving inspection in the drop-down menu.  
You can enter an additional comment in the "Note" line.
10. To complete the test procedure, select the desired option (print, discard or save) with the "Test result" test report.

## 9.4 Manual testing

Manual testing is intended for tests of electrical devices after repair or modification and for periodic testing.

### Requirements

- Please observe the requirements for measuring [[▶ page 71](#)].
- Approved safety measuring lines

### Menu

Main menu > VDE 0701, VDE 0702

Main menu > VDE 0751-1

Main menu > VDE 0544-4

### Procedure

1. Select the desired test standard in the main menu.
  - VDE 0701, VDE 0702
  - VDE 0751-1
  - VDE 0544-4
2. Select the corresponding protection class of the test sample.

The “Visual inspection” screen with the standard visual inspection is displayed.
3. Carry out a visual inspection.

If you want to carry out the advanced or customer-specific visual inspection, select the desired visual inspection. To do this, tap the “Visual inspection” line in the upper right of the screen to open the selection. Tap the desired visual inspection and confirm your selection with "OK".

The desired visual inspection is displayed. You can adapt it to your needs by showing and hiding the individual questions and then start the visual inspection.
4. Evaluate the result of the visual inspection [[▶ page 41](#)].
  - There are no defects:  
Confirm using the button “OK” or “All OK”.  
If there are no serious defects, tap the "Start" button to complete the visual inspection and start the test procedure.
  - There are defects: Evaluate the defect with the "Error" button or for each negative result with the "F" button for ‘fail’ or “N.a.” for ‘not available’.  
If there are serious defects, stop the test. To do this, tap the "Done" button to go directly to the test report.
5. Select the desired individual test.

Carry out the individual test [[▶ page 79](#)]. To do this, follow the instructions on the display and the instructions for the respective individual test.
6. Stop the individual test. To do this, tap the "Stop" button.

The result of the individual test is displayed.
7. Tap the “Back” button to go back to the overview of the individual tests.

Tap the "Start" button to carry out the individual test again.
8. Carry out all of the desired individual tests. To do this, follow the steps 5 to 7.

9. When you have carried out all the required individual tests, complete the test procedure. To do this, tap the “Done” button on the overview screen of the individual tests.

The test report "Test result" is displayed.

10. Select a test sample from the database in the “Device” line or create a new test sample.
11. Select the test type.
12. You can enter an additional comment in the “Note” line.
13. To complete the test procedure, select the desired option (print, discard or save) with the “Test result” test report.

## 9.5 Individual tests

This chapter describes the procedure for individual tests in the automatic and manual testing modes.

### 9.5.1 Testing the protective conductor resistance

Testing the protective conductor resistance [▶ page 42] is intended to check a test sample for proper and safe connection to all accessible conductive parts that are connected to the protective conductor.

#### Requirements

- Approved safety measuring lines
- Please observe the requirements for measuring [▶ page 71].
- The test sample is disconnected from the mains.
- Make sure that you are familiar with the procedure for manual [▶ page 77] and automatic [▶ page 76] testing.
- Make sure that you know the necessary measuring points.
- The test sample is connected according to the connection diagram.
- Please observe the operating manual and the technical data of the test sample.

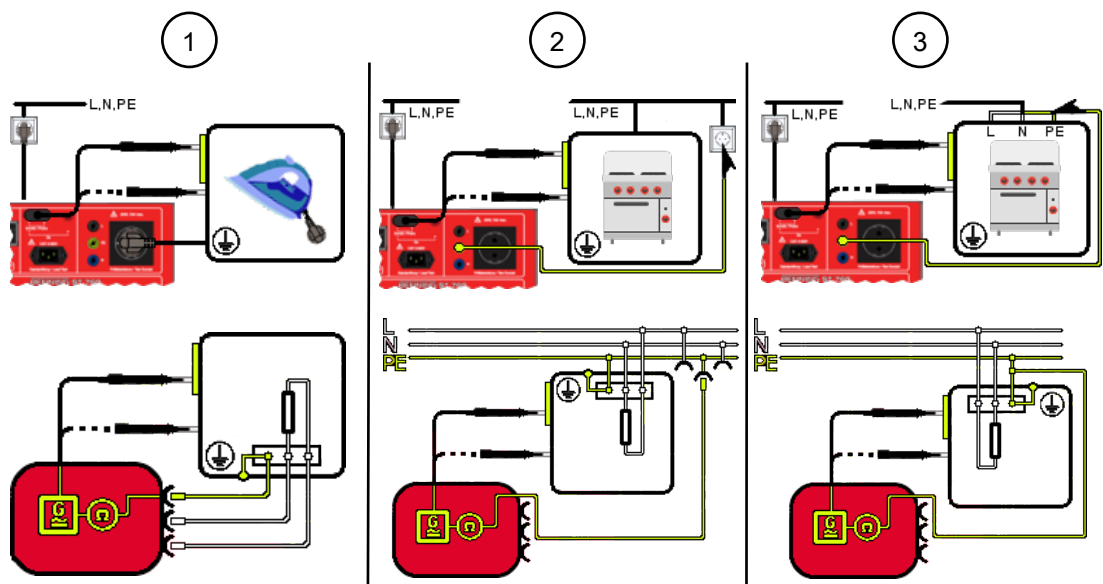

Figure 12: Testing the protective conductor resistance (connection diagram exemplary for VDE 0701 and VDE 0702, circuit diagram)

1	Portable test sample (Class I, $R_{PE}$ ) The shock-proof plug of the test sample is plugged into the test socket of the device. Use the test probe for measuring on all accessible conductive components of the test sample that are connected to the protective conductor.
2	Stationary test sample (Class I, $R_{PE}$ ) Establish a connection between a parallel PE section (e. g. a shock-proof socket in the same circuit) and the PE jack of the device. Use the test probe for measuring on all accessible conductive components of the test sample that are connected to the protective conductor.

3	<p>Stationary test sample (Class I, <math>R_{PE}</math>)</p> <p>Establish a connection between the PE jack of the device and the protective conductor connection point of the test sample. Use the test probe for measuring on all accessible conductive components of the test sample that are connected to the protective conductor.</p>
---	--

**Procedure**

1. Apply the test probe to the first measuring point and start the test.
2. During the measurement, move all movable individual parts of the protective conductor section.
3. Observe the measured values on the display. The highest measured value will be saved.
4. When the acoustic signal is emitted, apply the test probe to the next measuring point.  
Repeat the measuring steps 2 to 4 at all other measuring points.

**9.5.2 Testing the insulating resistance**

The insulating resistance test [▶ page 43] is intended to check the insulation of the test sample for a sufficiently high resistance. A high insulating resistance ensures that no fault currents can flow off if all sections of the test sample have been covered by the test.

**Requirements**

- Approved safety measuring lines
- Please observe the requirements for measuring [▶ page 71].
- The test sample is disconnected from the mains.
- Make sure that you are familiar with the procedure for manual [▶ page 77] and automatic [▶ page 76] testing.
- The test sample has passed the protective conductor resistance test [▶ page 79].
- Make sure that you know the necessary measuring points.
- The test sample is connected according to the connection diagram.

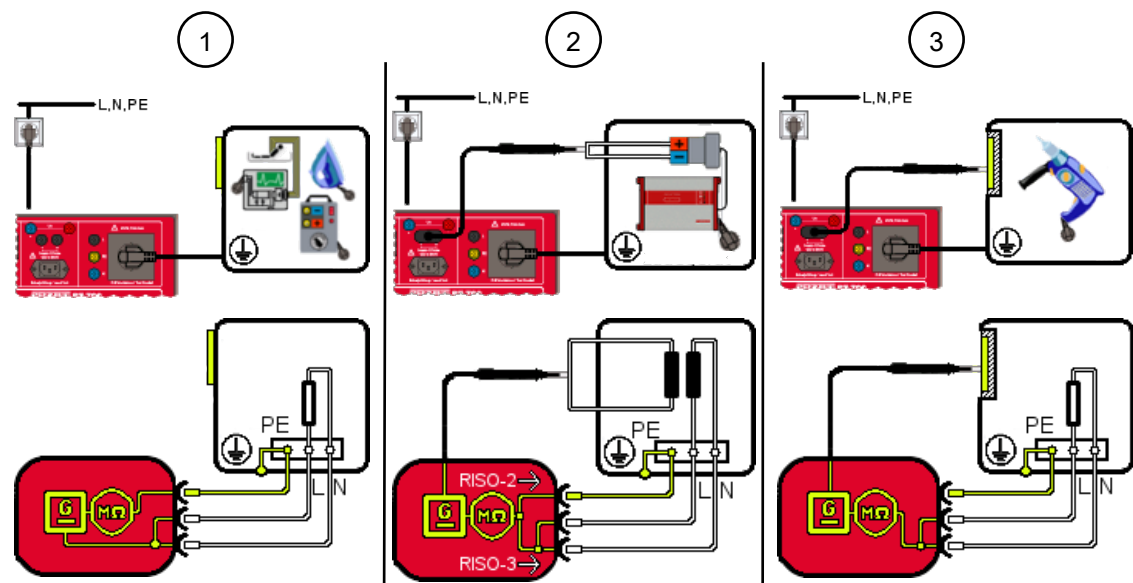

Figure 13: Testing the insulating resistance, Class I (connection diagram exemplary for VDE 0701 and VDE 0702, circuit diagram)



1	LN to PE (Class I, $R_{Insu-1}$ ) The shock-proof plug of the test sample is plugged into the test socket of the device.
2	Secondary side to PE (Class I, $R_{Insu-2}$ ) The shock-proof plug of the test sample is plugged into the test socket of the device. Use the test probe for measuring on the secondary side of the test sample.  LN to secondary side (Class I, $R_{Insu-3}$ ) The shock-proof plug of the test sample is plugged into the test socket of the device. Use the test probe for measuring on the secondary side of the test sample.
3	LN to accessible parts without PE (Class I, $R_{Insu-4}$ ) The shock-proof plug of the test sample is plugged into the test socket of the device. Use the test probe for measuring on all components of the test sample without PE connection.

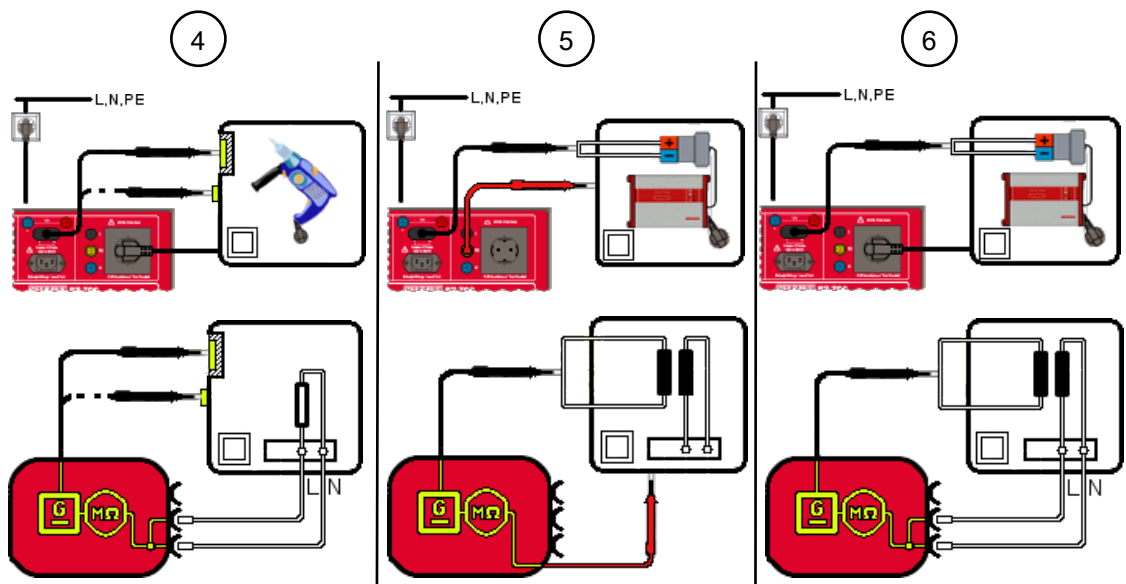

Figure 14: Testing the insulating resistance, Class II (connection diagram exemplary for VDE 0701 and VDE 0702, circuit diagram)

4	LN to test body (Class II, $R_{Insu-1}$ ) The shock-proof plug of the test sample is plugged into the test socket of the device. Use the test probe for measuring on all accessible conductive components of the test sample.
5	Secondary side to test body (Class II, $R_{Insu-2}$ ) Use the probe tip (PE jack) for measuring on the body of the test sample and use the test probe for measuring on the secondary side of the test sample.
6	LN to secondary side (Class II, $R_{Insu-3}$ ) The shock-proof plug of the test sample is plugged into the test socket of the device. Use the test probe for measuring on the secondary side and on the body of the test sample.

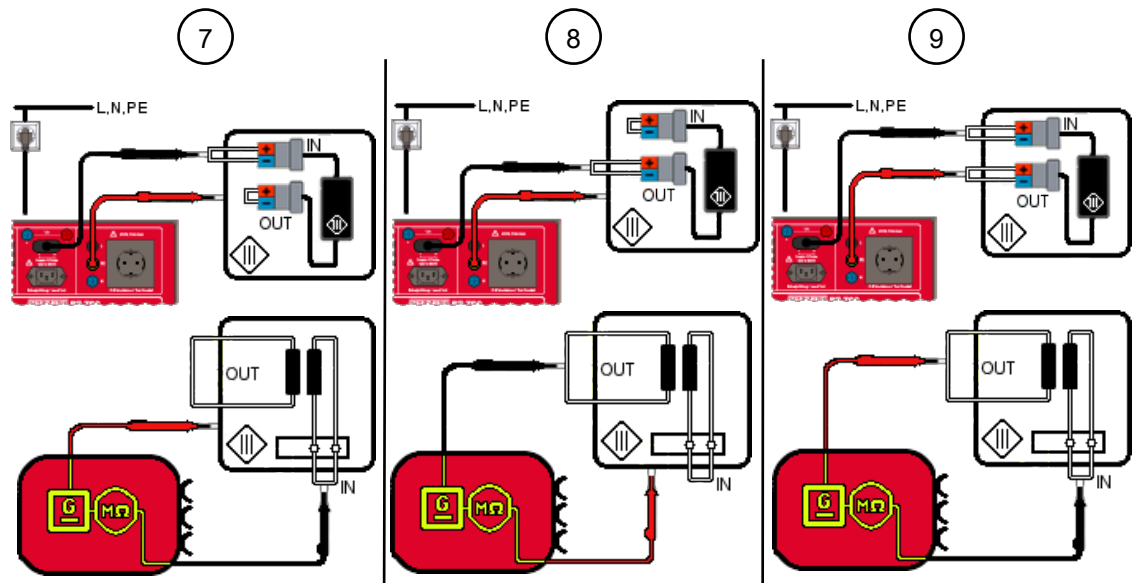

Figure 15: Testing the insulating resistance, Class III (connection diagram exemplary for VDE 0701 and VDE 0702, circuit diagram)

7	Input to test body (Class III, $R_{Insu-1}$ ) Use the probe tip (PE jack) for measuring on the body of the test sample and use the test probe for measuring on the input of the test sample.
8	Output to test body (Class III, $R_{Insu-2}$ ) Use the probe tip (PE jack) for measuring on the body of the test sample and use the test probe for measuring on the output of the test sample.
9	Output to test body (Class III, $R_{Insu-3}$ ) Use the probe tip (PE jack) for measuring on the output of the test sample and use the test probe for measuring on the input of the test sample.

## Procedure

1. Start the individual test.
2. Carry out the first measurement. If there are several measuring points, pause the measurement. To do this, tap the "Pause" button.
3. Apply the test probe / probe tip to the next measuring point.
4. Continue the measurement. To do this, tap the "Next" button.

### 9.5.3 Testing the protective conductor current

The protective conductor current test [▶ page 44] is intended to check test samples of protection class I for proper insulation capacity at mains voltage. This is to ensure that no leakage or fault current flows from the active parts to earth and that there is no risk of a dangerous electric flow via accessible conductive components.

#### Requirements

- Approved safety measuring lines
- Please observe the requirements for measuring [▶ page 71].
- The test sample is disconnected from the mains.
- Make sure that you are familiar with the procedure for manual [▶ page 77] and automatic [▶ page 76] testing.
- Make sure that you know the necessary measuring points.
- The test sample is connected according to the connection diagram.
- Please observe the operating manual and the technical data of the test sample.

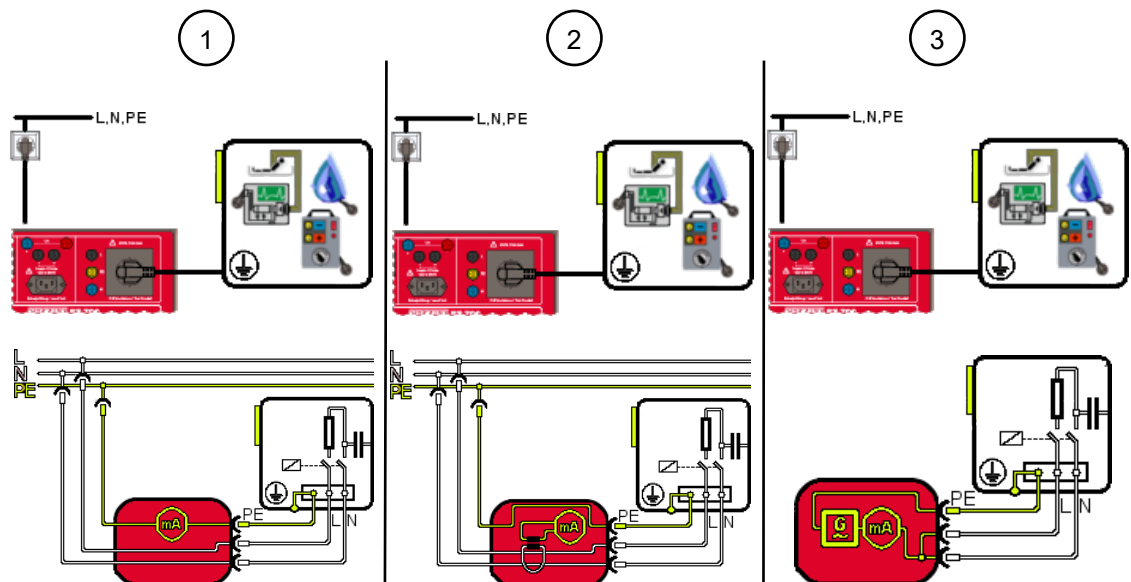

Figure 16: Testing the protective conductor current (connection diagram, circuit diagram)

1	Direct current measuring method (Class I, $I_{PE}$ ) The shock-proof plug of the test sample is plugged into the test socket of the device.
2	Differential current measuring method (Class I, $I_{PE}$ ) The shock-proof plug of the test sample is plugged into the test socket of the device.
3	Alternative leakage current measuring method (Class I, $I_{PE}$ ) The shock-proof plug of the test sample is plugged into the test socket of the device.

#### Procedure

1. Start the test.
2. If you are using the direct or differential current measuring method, change the polarity of the mains voltage at the test socket [▶ page 31].  
Test the test sample in all switch positions (test sample functions), if available.

## 9.5.4 Testing the contact current

The contact current test [▶ page 44] is intended to check the test sample for contact current on every accessible conductive part without protective conductor connection. This is to ensure that there is no risk of a dangerous electric flow via accessible conductive parts.

### Requirements

- Approved safety measuring lines
- Please observe the requirements for measuring [▶ page 71].
- The test sample is disconnected from the mains.
- Make sure that you are familiar with the procedure for manual [▶ page 77] and automatic [▶ page 76] testing.
- The test sample has passed the insulating resistance test [▶ page 80].
- Make sure that you know the necessary measuring points.
- The test sample is connected according to the connection diagram.

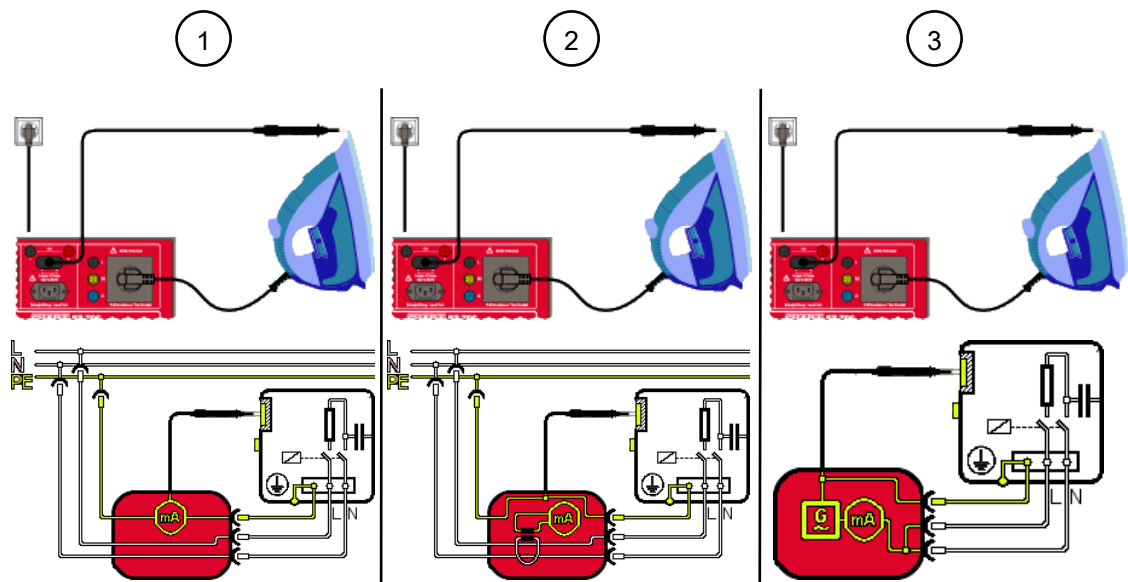

Figure 17: Testing the contact current, Class I (connection diagram exemplary for VDE 0701 and VDE 0702, circuit diagram)

1	Direct current measuring method (Class I, $I_{Cont}$ ) The shock-proof plug of the test sample is plugged into the test socket of the device. Use the test probe for measuring on all accessible conductive components of the test sample without PE connection.
2	Differential current measuring method (Class I, $I_{Cont}$ ) The shock-proof plug of the test sample is plugged into the test socket of the device. Use the test probe for measuring on all accessible conductive components of the test sample without PE connection.
3	Alternative leakage current measuring method (Class I, $I_{Cont}$ ) The shock-proof plug of the test sample is plugged into the test socket of the device. Use the test probe for measuring on all accessible conductive components of the test sample without PE connection.

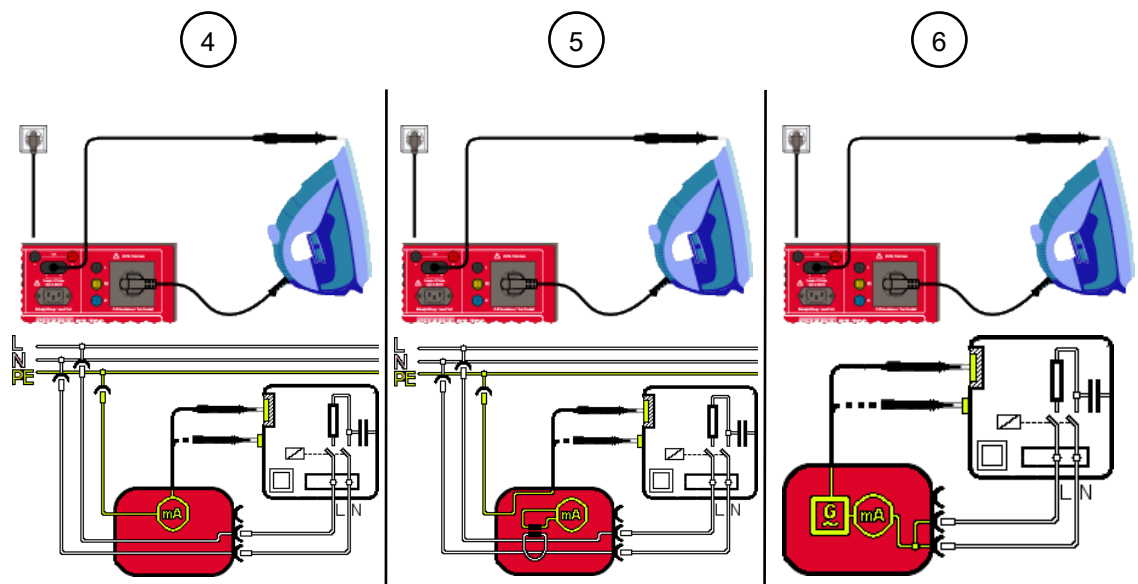

Figure 18: Testing the contact current, Class II (connection diagram exemplary for VDE 0701 and VDE 0702, circuit diagram)

4	<p>Direct current measuring method (Class II, <math>I_{\text{Cont}}</math>)</p> <p>The shock-proof plug of the test sample is plugged into the test socket of the device. Use the test probe for measuring on all accessible conductive components of the test sample.</p>
5	<p>Differential current measuring method (Class II, <math>I_{\text{Cont}}</math>)</p> <p>The shock-proof plug of the test sample is plugged into the test socket of the device. Use the test probe for measuring on all accessible conductive components of the test sample.</p>
6	<p>Alternative leakage current measuring method (Class II, <math>I_{\text{Cont}}</math>)</p> <p>The shock-proof plug of the test sample is plugged into the test socket of the device. Use the test probe for measuring on all accessible conductive components of the test sample.</p>

## Procedure

1. Start the test.
2. Use the test probe to scan all accessible conductive components of the test sample.
3. If you are using the direct or differential current measuring method, change the polarity of the mains voltage at the test socket [► page 31].
4. Use the test probe again to scan all accessible conductive components of the test sample. Test the test sample in all switch positions (test sample functions), if available.

## 9.5.5 Testing the device leakage current

The device leakage current test [▶ page 44] is intended to check medical electrical devices of protection classes I and II for proper insulation capacity at mains voltage. This is to ensure that no leakage current flows from the active components, the housing or accessible conductive components to earth and that there is no risk of a dangerous electric flow via accessible conductive components.

### Requirements

- Approved safety measuring lines
- Please observe the requirements for measuring [▶ page 71].
- The test sample is disconnected from the mains.
- Make sure that you are familiar with the procedure for manual [▶ page 77] and automatic [▶ page 76] testing.
- The test sample has passed the protective conductor resistance test [▶ page 79].
- Make sure that you know the necessary measuring points.
- The test sample has passed the insulating resistance test [▶ page 80].
- The measuring circuit of the setup must be closed.
- The test sample is connected according to the connection diagram.

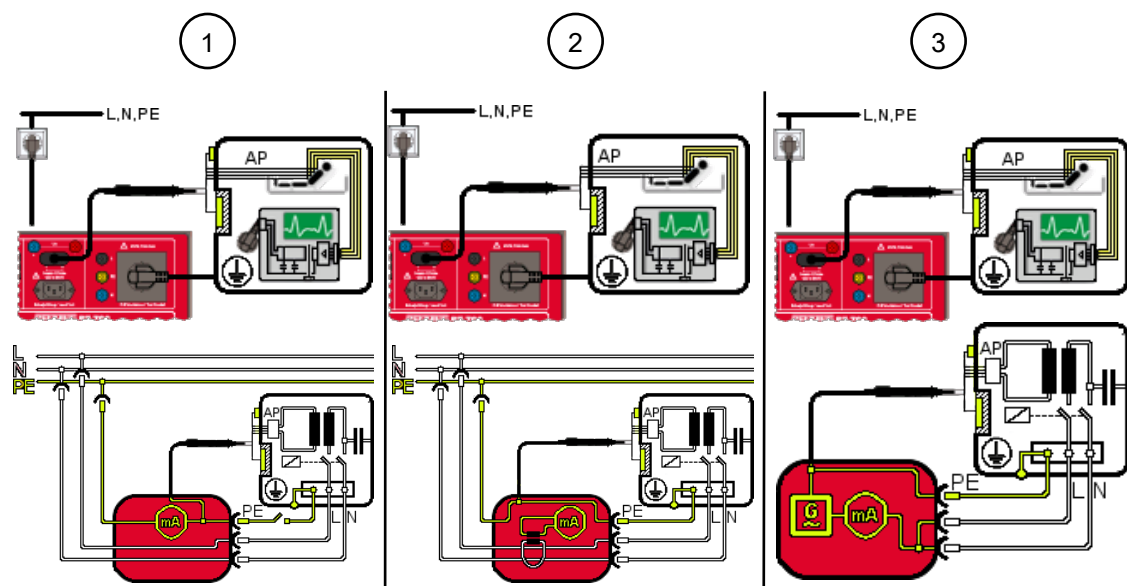

Figure 19: Testing the device leakage current (connection diagram for VDE 0751-1, circuit diagram)

1	Direct current measuring method (Class I, $I_{Leak}$ ) The shock-proof plug of the test sample is plugged into the test socket of the device. Use the test probe for measuring on all accessible conductive components and applied parts of the test sample.
2	Differential current measuring method (Class I, $I_{Leak}$ ) The shock-proof plug of the test sample is plugged into the test socket of the device. Use the test probe for measuring on all accessible conductive components and applied parts of the test sample.
3	Alternative leakage current measuring method (Class I, $I_{Leak}$ ) The shock-proof plug of the test sample is plugged into the test socket of the device. Use the test probe for measuring on all accessible conductive components and applied parts of the test sample.

## Procedure

1. Start the test.
2. Use the test probe to scan all accessible conductive components of the test sample.
3. If you are using the direct or differential current measuring method, change the polarity of the mains voltage at the test socket [► page 31].
4. Use the test probe again to scan all accessible conductive components of the test sample.  
Test the test sample in all switch positions (test sample functions), if available.  
In the case of automatic testing, the test is completed automatically. Only if the test time for automatic testing is set to 'infinite' (0), measurement must be completed manually.

## Result

If the value measured with the alternative leakage current measuring method exceeds 1 mA, you must carry out the direct current measuring method.

### 9.5.6 Testing the patient leakage current

The patient leakage current test [► page 45] is intended to check medical electrical devices of protection classes I and II for proper insulation capacity at mains voltage. This is to ensure that no leakage current flows from the active applied parts to earth and that there is no risk of a dangerous electric flow for the patient.

## Requirements

- Approved safety measuring lines
- Please observe the requirements for measuring [► page 71].
- The test sample is disconnected from the mains.
- Make sure that you are familiar with the procedure for manual [► page 77] and automatic [► page 76] testing.
- The test sample has passed the protective conductor resistance test [► page 79].
- Make sure that you know the necessary measuring points.
- The test sample has passed the insulating resistance test [► page 80].
- The measuring circuit of the setup must be closed.
- The test sample is connected according to the connection diagram.

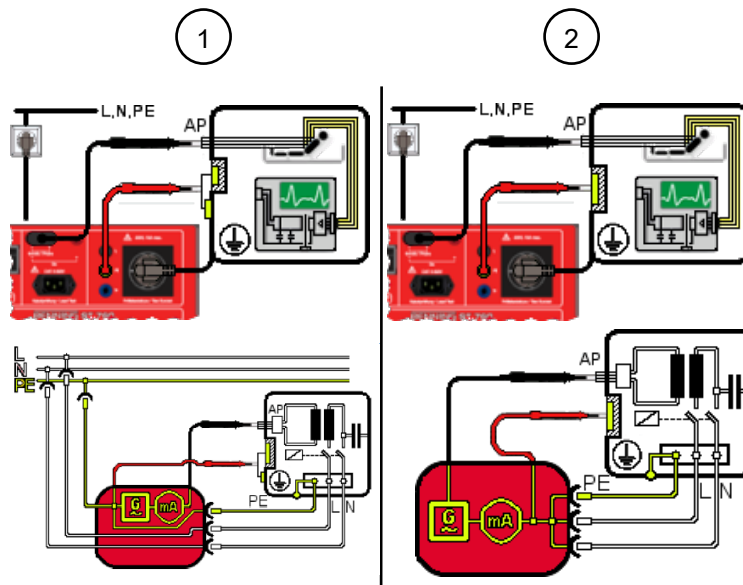

Figure 20: Testing the patient leakage current, Class I (connection diagram for VDE 0751-1, circuit diagram, applied parts of type F)

1	<p>Direct current measuring method (Class I, <math>I_{Leak}</math>)</p> <p>The shock-proof plug of the test sample is plugged into the test socket of the device. Use the probe tip (PE jack) for measuring on the body of the test sample and use the test probe for measuring on all accessible conductive components and applied parts of the test sample.</p>
2	<p>Alternative leakage current measuring method (Class I, <math>I_{Leak}</math>)</p> <p>The shock-proof plug of the test sample is plugged into the test socket of the device. Use the probe tip (PE jack) for measuring on the body of the test sample and use the test probe for measuring on all accessible conductive components and applied parts of the test sample.</p>

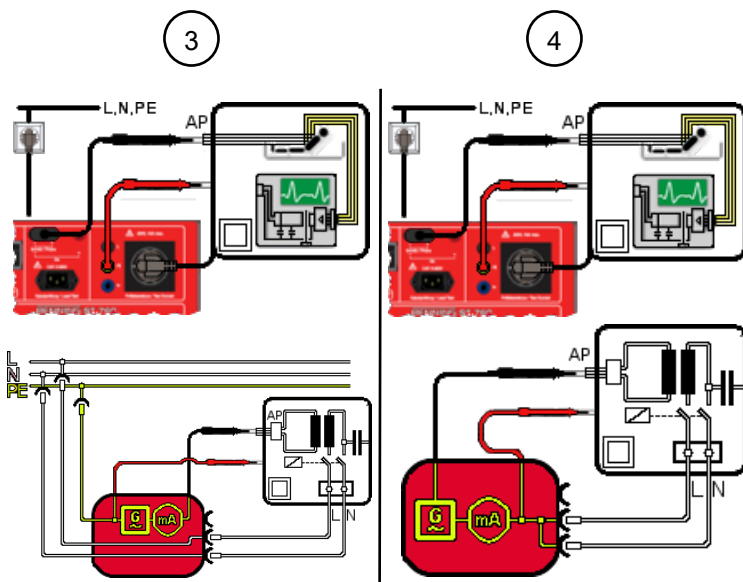

Figure 21: Testing the patient leakage current, Class II (connection diagram for VDE 0751-1, circuit diagram, applied parts of type F)



3	<p>Direct current measuring method (Class II, <math>I_{PLeak}</math>)</p> <p>The shock-proof plug of the test sample is plugged into the test socket of the device. Use the probe tip (PE jack) for measuring on the body of the test sample and use the test probe for measuring on all accessible conductive components and applied parts of the test sample.</p>
4	<p>Alternative leakage current measuring method (Class II, <math>I_{PLeak}</math>)</p> <p>The shock-proof plug of the test sample is plugged into the test socket of the device. Use the probe tip (PE jack) for measuring on the body of the test sample and use the test probe for measuring on all accessible conductive components and applied parts of the test sample.</p>

## Procedure

1. Start the test.
2. Use the test probe to scan all accessible conductive components of the test sample.
3. If you are using the direct or differential current measuring method, change the polarity of the mains voltage at the test socket [► page 31].
4. Use the test probe again to scan all accessible conductive components of the test sample.  
 Test the test sample in all switch positions (test sample functions), if available.  
 In the case of automatic testing, the test is completed automatically. Only if the test time for automatic testing is set to 'infinite' (0), measurement must be completed manually.

## Result

If the value measured with the alternative leakage current measuring method exceeds 1 mA, you must carry out the direct current measuring method.

## 9.5.7 Functional test

The functional test [▶ page 45] is intended for the final verification of electrical safety.

### Requirements

- Approved safety measuring lines
- Please observe the requirements for measuring [▶ page 71].
- The test sample is disconnected from the mains.
- Make sure that you are familiar with the procedure for manual [▶ page 77] and automatic [▶ page 76] testing.
- Make sure that you know the necessary measuring points.
- The test sample has passed the safety test.
- The test sample is connected according to the connection diagram.

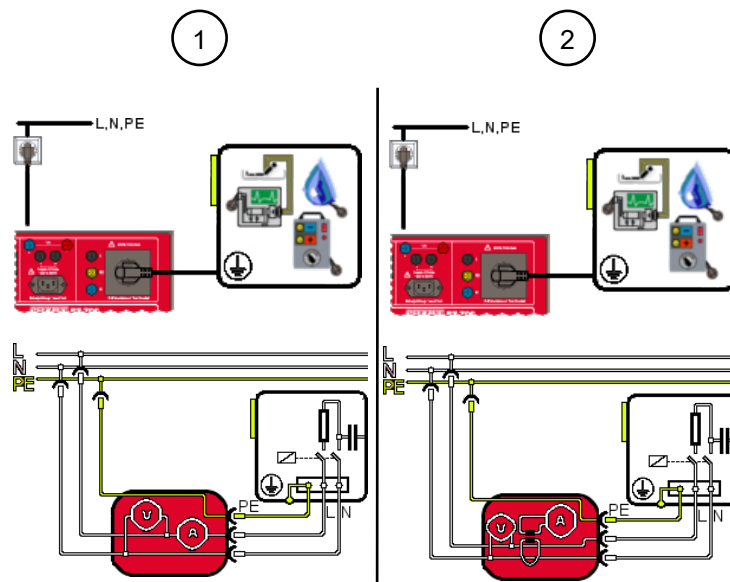

Figure 22: Functional test (connection diagram, circuit diagram)

1	Direct current measuring method (Class I, function) The shock-proof plug of the test sample is plugged into the test socket of the device.
2	Differential current measuring method (Class I, function) The shock-proof plug of the test sample is plugged into the test socket of the device.

### Procedure

1. Start the test.
2. When testing a test sample of protection class II, use the test probe to scan all accessible conductive components of the test sample for contact current testing. For leakage current measurement, scan all active accessible and conductive components that are connected to the housing.  
Please observe inductive and capacitive circuits.
3. Change the polarity of the mains voltage at the test socket [▶ page 31].
4. Use the test probe again to scan all components.  
Test the test sample in all switch positions (test sample functions), if available.

## 9.5.8 Cable continuity test

The cable continuity test [▶ page 46] is intended to measure the line resistance.

### Requirements

- Approved safety measuring lines
- Please observe the requirements for measuring [▶ page 71].
- The test sample is disconnected from the mains.
- Make sure that you are familiar with the procedure for manual [▶ page 77] and automatic [▶ page 76] testing.
- Make sure that you know the necessary measuring points.
- The test sample is connected according to the connection diagram.

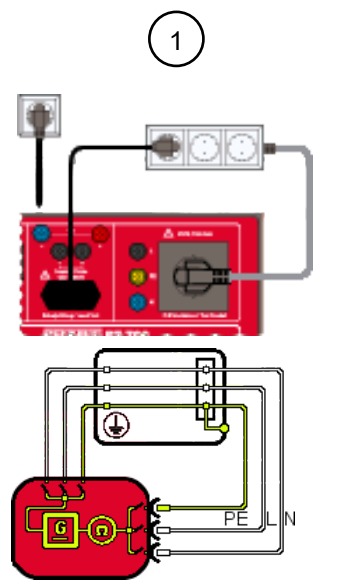

Figure 23: Cable continuity test (example: multiple socket, connection diagram, circuit diagram)

1	Cable continuity test (Class I, cable) Connection between test socket, test sample and IEC socket of the device.
---	---

### Procedure

1. If necessary, adjust the following limits:

- Line length [m]
- Line cross-section [mm<sup>2</sup>]
- Number of conductors
- R line per conductor [Ω]

2. Start the test.

The measurement is made continuously, so you have enough time to carry out the test. The device measures the line resistance of the conductors (L, N, PE) and all conductors in series.

## 9.5.9 Testing the safety extra-low voltage

The safety extra-low voltage test [▶ page 46] is intended to check the rated voltage of test samples with SELV / PELV voltages.

### Requirements

- Approved safety measuring lines
- Please observe the requirements for measuring [▶ page 71].
- The test sample is disconnected from the mains.
- Make sure that you are familiar with the procedure for manual [▶ page 77] and automatic [▶ page 76] testing.
- Make sure that you know the necessary measuring points.
- The test sample is connected according to the connection diagram.
- Please observe the operating manual and the technical data of the test sample.

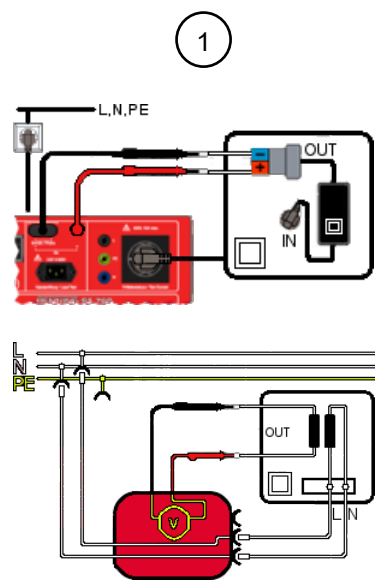

Figure 24: Testing the safety extra-low voltage, Class I (connection diagram, circuit diagram)

- |   |  |
|---|--|
| 1 | <p>Safety extra-low voltage (Class I, <math>U_a</math>)</p> <p>The shock-proof plug of the test sample is plugged into the test socket of the device. Use the test probes for measuring with correct polarity between both poles on the secondary side of the test sample.</p> |
|---|--|

### Procedure

1. Start the test.
2. Use the test probe for measuring on the poles of the secondary side.
3. Check the measured value for compliance with the technical data of the test sample. Please note that a battery voltage must be applied for the test sample to correctly switch through an output voltage.

## 9.5.10 Testing the voltage of the welding circuit

Testing the voltage of the welding circuit [▶ page 46] is intended to check the open-circuit voltage for compliance with the specifications regarding the rated voltages of test samples according to VDE 0544-4.

### Requirements

- Approved safety measuring lines
- Please observe the requirements for measuring [▶ page 71].
- The test sample is disconnected from the mains.
- Make sure that you are familiar with the procedure for manual [▶ page 77] and automatic [▶ page 76] testing.
- The test sample has passed the insulating resistance test [▶ page 80].
- Make sure that you know the necessary measuring points.
- The test sample is connected according to the connection diagram.

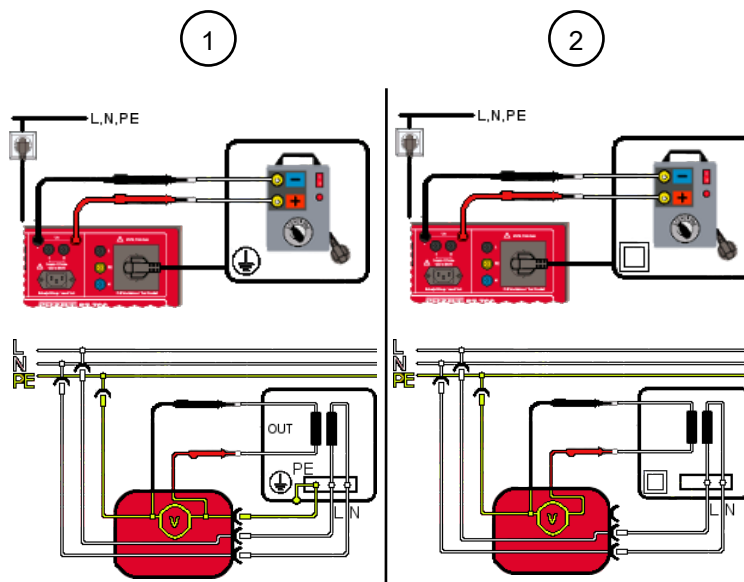

Figure 25: Testing the voltage of the welding circuit (connection diagram, circuit diagram)

1	Voltage of the welding circuit (Class I, $U_a$ ) The shock-proof plug of the test sample is plugged into the test socket of the device. Use the test probes for measuring with correct polarity between both poles on the secondary side of the test sample.
2	Voltage of the welding circuit (Class II, $U_a$ ) The shock-proof plug of the test sample is plugged into the test socket of the device. Use the test probes for measuring with correct polarity between both poles on the secondary side of the test sample.

**Procedure**

1. Start the test.
2. Use the test probe for measuring on the poles of the secondary side.
3. Check the measured values for compliance with the technical data of the test sample.
  - AC welding voltage
  - DC welding voltage
  - Peak value (peak) of the welding voltage
  - Welding current

**9.5.11 Testing the contact current of the welding circuit**

Testing the contact current of the welding circuit [▶ page 47] is intended to check the contact current for compliance with the rated values of test samples according to VDE 0544-4.

**Requirements**

- Approved safety measuring lines
- Please observe the requirements for measuring [▶ page 71].
- The test sample is disconnected from the mains.
- Make sure that you are familiar with the procedure for manual [▶ page 77] and automatic [▶ page 76] testing.
- Make sure that you know the necessary measuring points.
- The test sample is connected according to the connection diagram.
- Please observe the operating manual and the technical data of the test sample.

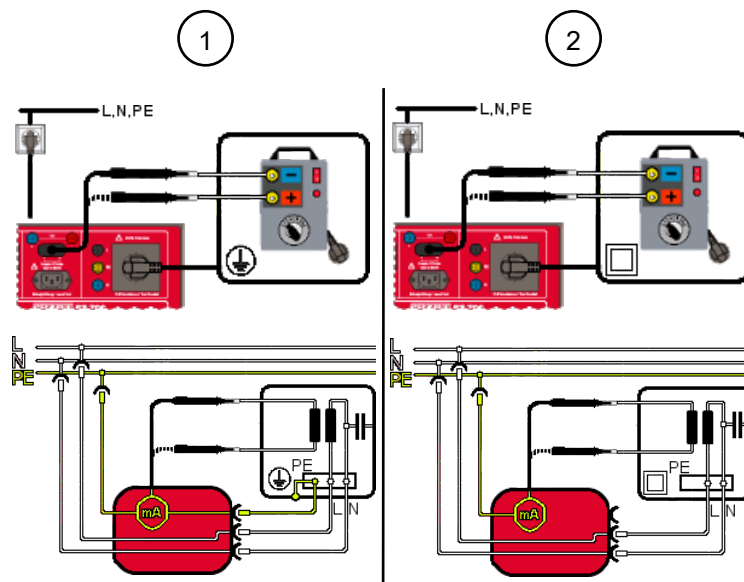

Figure 26: Testing the contact current of the welding circuit (connection diagram, circuit diagram)

1	<p>Contact current of the welding circuit (Class I, <math>I_{Cont}</math>)                  The shock-proof plug of the test sample is plugged into the test socket of the device.                  Use the test probe for measuring on both poles of the secondary side of the test sample.</p>
---	--

2	Contact current of the welding circuit (Class II, $I_{Cont}$ ) The shock-proof plug of the test sample is plugged into the test socket of the device. Use the test probe for measuring on both poles of the secondary side of the test sample.
---	---

## Procedure

1. Start the test.
2. Use the test probe for measuring on the poles of the secondary side.
3. Change the polarity of the mains voltage at the test socket.
4. Use the test probe again for measuring on the poles of the secondary side.
5. Check the measured value for compliance with the technical data of the test sample.

## 9.5.12 Testing of PRCDs

The testing of residual current protection devices [▶ page 47] is intended to check the functionality of portable residual current protection devices (PRCD).

## Menu

“Main menu > VDE 0701, VDE 0702 > Devices with PE (Class I)”

## Requirements

- Approved safety measuring lines
- Please observe the requirements for measuring [▶ page 71].
- The test sample is disconnected from the mains.
- Make sure that you are familiar with the procedure for manual [▶ page 77] and automatic [▶ page 76] testing.
- Make sure that you know the necessary measuring points.
- The test sample is connected according to the connection diagram.
- Please observe the operating manual and the technical data of the test sample.

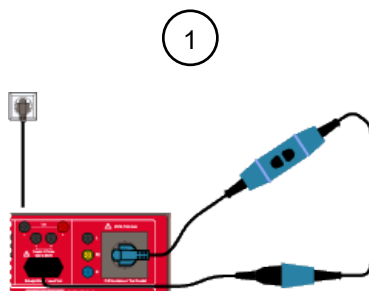

Figure 27: Testing of PRCDs (connection diagram)

1	Direct current measuring method (Class I, PRCD) Connection between test socket, test sample and IEC socket of the device.
---	--

## Procedure

1. Start the test.
2. Check the measured value for compliance with the technical data of the test sample.

# 10 Maintenance

There are no components in the device that you can replace.



## **⚠ WARNING**

### **Opening the device**

Danger to life or serious injury is possible due to contact with high electric voltage when opening the device. The device might get damaged.

- Do not open the device.
- Please contact your specialty retailer or the returns management [▶ page 12] for any repairs.

## 10.1 Maintenance schedule

The following table provides an overview of all maintenance and servicing work that you must carry out permanently or at regular intervals.

Interval	Measures
Regularly, as needed	<ul style="list-style-type: none"> <li>• Cleaning the device [▶ page 97]</li> </ul>
Every 12 months	<ul style="list-style-type: none"> <li>• Calibrating the device [▶ page 97]</li> </ul>

Table 27: Maintenance schedule

## 10.2 Making the device free of voltage

If you want to clean the device, make sure first that the device is free of voltage.

### **Procedure**

1. Remove the device from the measuring point.
2. Disconnect the safety measuring lines from the device.
3. Switch off the device.



## 10.3 Cleaning the device

Clean the device regularly and as the need arises.

### Requirements

- A clean and dry cloth or special cleaning cloth



### NOTICE

#### Wrong cleaning agents

Using the wrong cleaning agents can damage the device.

- Do not use any solvents, abrasives or polishing agents.

### Procedure

Clean the exterior of the device with a clean and dry cloth or a special cleaning cloth.

## 10.4 Calibrating the device

Benning guarantees compliance with this technical and accuracy specifications stated in this operating manual for the first 12 months after the delivery date.

To maintain accuracy of the measuring results, make sure that the device is recalibrated in annual intervals by the BENNING Service [▶ page 12].

As part of a calibration, the device is provided with the latest firmware update and thus always remains up to date.

<http://calibration.benning.de>



## 10.5 Installing an update (GUI, firmware)

The “Update (GUI, firmware)” menu is intended to update the GUI (Graphical User Interface) and firmware of the device.

### Requirements

- Update via network: The device is connected to a network via LAN or WLAN.
- Update via network: DHCP is enabled. (Or the IP address, subnet mask and standard gateway must be entered manually in the network settings.)
- You are logged on to the device as a user with admin status.
- You have saved a backup copy of existing databases.
- Mains supply of the device

An interruption of the update process might result in the device not being able to start anymore.

### Menu

“Settings > Expert settings > Update (GUI, firmware)”

### Procedure – Update via USB

1. Select the update file. To do this, follow the link below or the path provided:
  - <https://www.benning.de/service-de/soft-und-firmware.html>
  - <https://www.benning.de/produkte/pruef-und-messtechnik/geraetester-vde-0701-0702-0751-1.html>
2. Download the “.zip” file with the update.
3. Save the “.zip” file on a USB stick.  
Save the file directly on the USB stick and not in a subfolder.
4. Switch on the device.
5. Plug the USB stick with the “.zip” file into a USB-A port of the device.
6. Select the “Update via USB stick” option.
7. The detected update is shown on the display of the device.  
If no update is displayed, check the storage location of the “.zip” file on the USB stick.
8. Select the line of the detected update on the Display.
9. Confirm the prompt on the display.
10. The device unzips the “.zip” file and checks whether the available update is more recent than the installed firmware and GUI.  
Do not switch off the device during the update process. Wait until the device has installed the update completely.

### Procedure – Update via network

1. Switch on the device.
2. Select the “Update via network” option.
3. Select the line of the detected update on the Display.
4. Confirm the prompt on the display with "Yes".
5. The device unzips the “.zip” file and checks whether the available update is more recent than the installed firmware and GUI.

Do not switch off the device during the update process. Wait until the device has installed the update completely.

### Result

- The update is identical to the installed version or older:  
The device does not run the update and the following message is displayed: “The firmware of the tester is up to date. No update is required.”
- The update is more recent than the installed version:  
The device installs the update and then restarts.

The update of the device is now complete and you can remove the USB stick.

## 10.6 Recovering the password

If you are an admin user and you have forgotten your password, you can recover your password with the help of Technical support [► page 12].

### Requirements

- You have forgotten your access password.
- The following evidence and data are available:
  - Proof of purchase of the device
  - Serial number
  - User level
  - Index

### Procedure

1. Tap the “Forgotten?” button on the “Registration / login” screen.  
The “Forgot password...” screen opens.
2. Follow the instructions on the display.
3. Create a new password [► page 64].

# 11 Technical data

Protection class II	(as the protective conductor for the test socket is looped through)
Contamination level	2
Protection category (DIN VDE 0470-1, IEC / EN 60529)	<ul style="list-style-type: none"> <li>• IP 40 (with the cover being open)</li> <li>• IP 67 (with the cover being closed)</li> </ul>
Overvoltage category	CAT II
Mains connection	115 ... 230 V-AC ±10 %, 50 ... 60 Hz
Current consumption	<ul style="list-style-type: none"> <li>• Without test socket: 0.3 A</li> <li>• With test socket: 16 A</li> </ul>
Maximum load of the test socket	16 A
Maximum pre-fuse	16 A
Housing	Device case
Housing dimensions (length x width x height)	170 mm x 410 mm x 350 mm
Weight	6 kg
Display dimensions	115 mm x 87 mm
EMC	EN 61557-16, EN 61326-1, EN 61326-2-2
Max. barometric altitude	2 000 m
Operating temperature	0 ... 35 °C (do not permanently expose the device to sunlight)
Max. relative air humidity	80 % RH (0 ... 40 °C), non-condensing
Operating conditions	To be used inside buildings in dry environments
<b>Storage</b> (remove the batteries from the device)	
Ambient temperature	-20 ... 60 °C (do not permanently expose the device to sunlight)
Max. relative air humidity (linearly decreasing, non-condensing)	80 % at 30 °C 60 % at 40 °C

Table 28: Technical data

# 12 Disposal and environmental protection



At the end of product life, dispose of the unserviceable device and the batteries via appropriate collecting facilities provided in your community.

## Packaging

Please keep the original packaging for later dispatch (e. g. for calibration).

# 13 Appendix

## 13.1 Automatic test procedures

### 13.1.1 Automatic test procedures according to EN 50678 (VDE 0701) and EN 50699 (VDE 0702)

Test no.	Name	Individual tests
1	Devices of Class I	$R_{PE}$ (600 mA), $R_{Insu-1}$ (500 V), functional test with $I_{PE}$ (differential current measuring method)
2	Devices of Class I with $R_{PE}$ 10 A	$R_{PE}$ (10 A), $R_{Insu-1}$ (500 V), functional test with $I_{PE}$ (differential current measuring method)
3	Devices of Class I with $I_{Cont\ dir.}$	$R_{PE}$ (600 mA), $R_{Insu-1}$ (500 V), $I_{Cont}$ (dir.), functional test with $I_{PE}$ (diff.)
4	Devices of Class I without $R_{PE}$ + $I_{Cont\ dir.}$	Devices of Class I without $R_{PE}$ , with $I_{Cont\ dir.}$
5	Devices of Class I heating < 3.5 kW	$R_{PE}$ (600 mA), $R_{Insu-1}$ (500 V, $R \geq 0.3\ M\Omega$ ), functional test with $I_{PE}$ (diff.), for testing heating devices with $P < 3.5\ kW$
6	Devices of Class I with $I_{PE}$ alt.	$R_{PE}$ (600 mA), $R_{Insu-1}$ (500 V), $I_{PE}$ (alternative leakage current measuring method)
7	Devices of Class I with $R_{PE}$ 10 A + $I_{PE}$ alt.	$R_{PE}$ (10 A), $R_{Insu-1}$ (500 V), $I_{PE}$ (alternative leakage current measuring method), for testing extension cables up to 5 m or tools with 300 Hz such as power screwdrivers, grinding tools
8	Devices of Class I with $R_{Insu}$ 250 V	$R_{PE}$ (600 mA), $R_{Insu-1}$ (250 V), functional test with $I_{PE}$ (diff.), for testing devices with overvoltage arresters
9	Devices of Class I without $R_{Insu}$	$R_{PE}$ (600 mA), functional test with $I_{PE}$ (diff.), test procedure without $R_{Insu}$ only with factual basis and justification
10	Devices of Class I without $R_{Insu}$ + $I_{Cont\ dir.}$	$R_{PE}$ (600 mA), $I_{Cont}$ (dir.), functional test with $I_{PE}$ (diff.), test procedure without $R_{Insu}$ only with factual basis and justification
11	Devices of Class I with U out.	$R_{PE}$ (600 mA), $R_{Insu-1}$ (500 V), $R_{Insu-2}$ (500 V), $R_{Insu-3}$ (500 V), $I_{Cont}$ (dir.), functional test with $I_{PE}$ (diff.), $U_a$ at the secondary output (max. 25 V), e. g. for testing mains supply units and chargers
12	Devices of Class I with $I_{PE}$ clamp	$R_{PE}$ (600 mA) and $R_{Insu-1}$ (500 V) with BENNING CM 9-1 / CM 9-2 and adapter, item no.: 044127 / 044128, $I_{PE}$ (clamp measurement)
13	Devices of Class I $R_{PE}$ 10 A with $I_{PE}$ clamp	$R_{PE}$ (10 A) and $R_{Insu-1}$ (500 V) with BENNING CM 9-1 / CM 9-2 and adapter, item no.: 044127 / 044128, $I_{PE}$ (clamp measurement)
14	Shock-proof cable with probe $R_{Insu}$ 500 V	$R_{PE}$ (600 mA), $R_{Insu-1}$ (500 V), cable (line length 5 m / line cross-section 1.5 mm <sup>2</sup> / number of conductors = 3 / resistance value per line 0.3 $\Omega$ , for line tests of shock-proof cables

Test no.	Name	Individual tests
15	Shock-proof cable with probe $R_{Insu}$ 250 V	$R_{PE}$ (600 mA), $R_{Insu-1}$ (250 V), cable (line length 5 m / line cross-section 1.5 mm <sup>2</sup> / number of conductors = 3 / resistance value per line 0.3 $\Omega$ , for line tests of shock-proof cables
16	Shock-proof cable without probe	$R_{Insu-1}$ (500 V), cable (line length 5 m / line cross-section 1.5 mm <sup>2</sup> / number of conductors = 3 / resistance value per line 0.3 $\Omega$ , for line tests of shock-proof cables
17	Devices of Class I, three-phase	$R_{PE}$ (600 mA), $R_{Insu-1}$ (500 V), functional test three-phase with $I_{PE}$ (diff. / dir.), possible adapters: MA 2-16 (switch-over diff./dir.), MA 4 (always with differential current measuring method)
18	Devices of Class I $R_{PE}$ 10 A, three-phase	$R_{PE}$ (10 mA), $R_{Insu-1}$ (500 V), functional test three-phase with $I_{PE}$ (diff. / dir.), possible adapters: MA 2-16 (switch-over diff./dir.), MA 4 (always with differential current measuring method)
19	Power distributor RCD type A	$R_{PE}$ (600 mA), $R_{Insu-IN}$ (500 V), $R_{Insu-OUT}$ (500 V), $I_{PE}$ (diff.), RCD type A (30 mA), possible adapters: MA 2-16 (switch-over diff./dir.), MA 4 (always with differential current measuring method)
20	Power distributor RCD type B	$R_{PE}$ (600 mA), $R_{Insu-IN}$ (500 V), $R_{Insu-OUT}$ (500 V), $I_{PE}$ (diff.), RCD type B (30 mA), possible adapters: MA 2-16 (switch-over diff./dir.), MA 4 (always with differential current measuring method)
21	CEE extension adapter	$R_{PE}$ (600 mA), $R_{Insu-1}$ (500 V), functional test (continuity, short-circuit, phase sequence), possible adapters: item no. 044122 / 044123 / 044147, MA 3, MA 4
22	CEE devices of Class I with $I_{PE}$ alt.	$R_{PE}$ (600 mA), $R_{Insu-1}$ (500 V), $I_{PE}$ (alt.), possible adapters: item no. 044122 / 044123 / 044147, MA 2-16, MA 3, MA 4
23	PRCD-S	$R_{PE}$ (600 mA), $R_{Insu-IN}$ (500 V), $R_{Insu-OUT}$ (500 V), $I_{PE}$ (diff.), $I_{Cont}$ (dir.), PRCD-S (30 mA)
24	PRCD-S+	$R_{PE}$ (600 mA), $R_{Insu-OUT}$ (500 V), $I_{PE}$ (diff.), $I_{Cont}$ (dir.), PRCD-S+ (30 mA)
25	PRCD-K	$R_{Insu-IN}$ (500 V), $R_{Insu-OUT}$ (500 V), $I_{PE}$ (diff.), PRCD-K (30 mA)
26	PRCD-AC	$R_{PE}$ (600 mA), $R_{Insu-IN}$ (500 V), $R_{Insu-OUT}$ (500 V), $I_{PE}$ (diff.), PRCD-AC (30 mA)
27	PRCD-A	$R_{PE}$ (600 mA), $R_{Insu-IN}$ (500 V), $R_{Insu-OUT}$ (500 V), $I_{PE}$ (diff.), PRCD-A (30 mA)
28	PRCD-F	$R_{PE}$ (600 mA), $R_{Insu-IN}$ (500 V), $R_{Insu-OUT}$ (500 V), $I_{PE}$ (diff.), PRCD-F (30 mA)
29	PRCD-B	$R_{PE}$ (600 mA), $R_{Insu-IN}$ (500 V), $R_{Insu-OUT}$ (500 V), $I_{PE}$ (diff.), PRCD-B (30 mA)
30	PRCD-B+	$R_{PE}$ (600 mA), $R_{Insu-IN}$ (500 V), $R_{Insu-OUT}$ (500 V), $I_{PE}$ (diff.), PRCD-B+ (30 mA)
31	PRCD 2-pin	$R_{PE}$ (600 mA), $R_{Insu-IN}$ (500 V), $R_{Insu-OUT}$ (500 V), $I_{PE}$ (diff.), PRCD 2-pin (30 mA)
32	PRCD 3-pin	$R_{Insu-IN}$ (500 V), $R_{Insu-OUT}$ (500 V), $I_{PE}$ (diff.), PRCD 3-pin (30 mA)

Table 29: Test procedures according to EN 50678 (VDE 0701) and EN 50699 (VDE 0702) for Class I

Test / test no.	1	2	3	4	5	6	7	8	9	10	11	12	13	14	15	16
Visual inspection	x	x	x	x	x	x	x	x	x	x	x	x	x	x	x	x
Connection test	x	x	x	x	x	x	x	x	x	x	x	x	x	x	x	x
$R_{PE}$ 600 mA	x	-	x	-	x	x	-	x	x	x	x	x	-	x	x	-
$R_{PE}$ 10 A	-	x	-	-	-	-	x	-	-	-	-	-	x	-	-	-
$R_{Insu-1} / R_{Insu-IN}$	x	x	x	x	x	x	x	x	-	-	x	x	x	x	x	x
$R_{Insu-2} / R_{Insu-IN}$	-	-	-	-	-	-	-	-	-	-	x	-	-	-	-	-
$R_{Insu-3}$	-	-	-	-	-	-	-	-	-	-	x	-	-	-	-	-
$R_{Insu-4}$	-	-	-	-	-	-	-	-	-	-	-	-	-	-	-	-
$I_{PE}$	-	-	-	-	-	x	x	-	-	-	-	x	x	-	-	-
$I_{Cont}$	-	-	x	x	-	-	-	-	-	x	x	-	-	-	-	-
Funct.	x	x	x	x	x	-	-	x	x	x	x	-	-	-	-	-
Cable	-	-	-	-	-	-	-	-	-	-	-	-	-	x	x	x
$U_a$	-	-	-	-	-	-	-	-	-	-	x	-	-	-	-	-
PRCD	-	-	-	-	-	-	-	-	-	-	-	-	-	-	-	-

Table 30: Overview of test procedures according to EN 50678 (VDE 0701) and EN 50699 (VDE 0702) for Class I (1 to 16)

Test / test no.	17	18	19	20	21	22	23	24	25	26	27	28	29	30	31	32
Visual inspection	x	x	x	x	x	x	x	x	x	x	x	x	x	x	x	x
Connection test	x	x	x	x	x	x	x	x	x	x	x	x	x	x	x	x
$R_{PE}$ 600 mA	x	-	x	x	x	x	x	x	-	x	x	x	x	x	x	-
$R_{PE}$ 10 A	-	x	-	-	-	-	-	-	-	-	-	-	-	-	-	-
$R_{Insu-1} / R_{Insu-IN}$	x	x	x	x	x	x	x	x	x	x	x	x	x	x	x	x
$R_{Insu-2} / R_{Insu-IN}$	-	-	x	x	-	-	x	x	x	x	x	x	x	x	x	x
$R_{Insu-3}$	-	-	-	-	-	-	-	-	-	-	-	-	-	-	-	-
$R_{Insu-4}$	-	-	-	-	-	-	-	-	-	-	-	-	-	-	-	-
$I_{PE}$	-	-	x	x	-	x	x	x	x	x	x	x	x	x	x	x
$I_{Cont}$	-	-	-	-	-	-	x	-	-	-	-	-	-	-	-	-
Funct.	x	x	-	-	x	-	-	-	-	-	-	-	-	-	-	-
Cable	-	-	-	-	-	-	-	-	-	-	-	-	-	-	-	-
$U_a$	-	-	-	-	-	-	-	-	-	-	-	-	-	-	-	-
PRCD	-	-	x	x	-	-	x	x	x	x	x	x	x	x	x	x

Table 31: Overview of test procedures according to EN 50678 (VDE 0701) and EN 50699 (VDE 0702) for Class I (17 to 32)

Test no.	Name	Individual tests
1	Devices of Class II	$R_{Insu-1}$ (500 V), functional test with $I_{Cont}$ (differential current measuring method)
2	Devices of Class II with $I_{Cont}$ alt.	$R_{Insu-1}$ (500 V), $I_{Cont}$ (alt.)
3	Devices of Class II with $R_{Insu}$ 250 V	$R_{Insu-1}$ (250 V), functional test with $I_{Cont}$ (differential current measuring method)
4	Devices of Class II without $R_{Insu}$	Functional test with $I_{Cont}$ (differential current measuring method)



## 13.1 Automatic test procedures

Test no.	Name	Individual tests
5	Devices of Class II without $R_{Insu} + I_{Cont\ dir.}$	$I_{Cont}$ (dir.), functional test with $I_{Cont}$ (differential current measuring method)
6	Devices of Class II with U output	$R_{Insu-3}$ (500 V), functional test with $I_{Cont}$ (differential current measuring method), $U_a$ (at secondary output)

Table 32: Test procedures according to EN 50678 (VDE 0701) and EN 50699 (VDE 0702) for Class II

Test no.	Name	Individual tests
1	Devices of Class III	$R_{Insu-3}$ (500 V), $U_a$ (at secondary output)

Table 33: Test procedures according to EN 50678 (VDE 0701) and EN 50699 (VDE 0702) for Class III

Test / test no.	1	2	3	4	5	6	1
Protection class	Class II						Class III
Visual inspection	X	X	X	X	X	X	X
Connection test	X	X	X	X	X	X	X
$R_{Insu-1} / R_{Insu-IN}$	X	X	X	-	-	-	-
$R_{Insu-3}$	-	-	-	-	-	X	X
$I_{Cont}$	-	X	-	-	X	-	-
Funct.	X	-	X	X	X	X	-
$U_a$	-	-	-	-	-	X	X

Table 34: Overview of test procedures according to EN 50678 (VDE 0701) and EN 50699 (VDE 0702) for Class II (1 to 6) / Class III (1)

### 13.1.2 Automatic test procedures according to EN 62353 (VDE 0751-1)

Test no.	Name	Individual tests
1	Medical devices of Class I	$R_{PE}$ (600 mA), $R_{Insu-1}$ (500 V), functional test with $I_{Leak}$ (differential current measuring method)
2	Medical devices of Class I without $R_{Insu}$	$R_{PE}$ (600 mA), functional test with $I_{Leak}$ (differential current measuring method)
3	Med. devices of Class I type BF	$R_{PE}$ (600 mA), $R_{Insu-1}$ (500 V), $R_{Insu-2}$ (250 V), $R_{Insu-3}$ (500 V), $I_{Leak}$ (diff.), $I_{PLeak}$ (alt., type BF), functional test with $I_{Leak}$ (diff.)
4	Med. devices of Class I type CF	$R_{PE}$ (600 mA), $R_{Insu-1}$ (500 V), $R_{Insu-2}$ (250 V), $R_{Insu-3}$ (500 V), $I_{Leak}$ (diff.), $I_{PLeak}$ (alt., type CF), functional test with $I_{Leak}$ (diff.)
5	Med. devices of Class I type B	$R_{PE}$ (600 mA), $R_{Insu-1}$ (500 V), $R_{Insu-2}$ (250 V), $R_{Insu-3}$ (500 V), $I_{Leak}$ (diff.), $I_{PLeak}$ (alt., type B), functional test with $I_{Leak}$ (dir.)

Table 35: Test procedures according to EN 62353 (VDE 0751-1) for Class I

Test no.	Name	Individual tests
1	Medical devices of Class II	$R_{Insu-1}$ (500 V), functional test with $I_{Leak}$ (differential current measuring method)
2	Medical devices of Class II without $R_{Insu}$	Functional test with $I_{Leak}$ (differential current measuring method)

Table 36: Test procedures according to EN 62353 (VDE 0751-1) for Class II

Test / test no.	1	2	3	4	5	1	2
Protection class	Class I					Class II	
Visual inspection	X	X	X	X	X	X	X
Connection test	X	X	X	X	X	X	X
$R_{PE}$ 600 mA	X	X	X	X	X	-	-
$R_{Insu-1} / R_{Insu-IN}$	X	-	X	X	X	X	-
$R_{Insu-2}$	-	-	X	X	X	-	-
$R_{Insu-3}$	-	-	X	X	X	-	-
$I_{Leak}$	-	-	X	X	X	-	-
$I_{PLeak}$	-	-	X	X	X	-	-
Funct.	X	X	X	X	X	X	X

Table 37: Overview of test procedures according to EN 62353 (VDE 0751-1) for Class I (1 to 5) / Class II (1 to 2)

### 13.1.3 Automatic test procedures according to EN 60974-4 (VDE 0544-4)

Test no.	Name	Individual tests
1	Welding device of Class I, single-phase	$R_{PE}$ (600 mA), $R_{Insu-1}$ (500 V), $R_{Insu-2}$ (250 V), $R_{Insu-3}$ (500 V), $I_{Cont}$ (dir.), $I_{Cont weld.}$ (dir.), functional test with $I_{PE}$ (diff.), $U_{a weld.}$ (max. 80 V-AC / max. 80 V-DC / max. peak value 113 V)
2	Welding device of Class I, three-phase	$R_{PE}$ (600 mA), $R_{Insu-1}$ (500 V), $R_{Insu-2}$ (250 V), $R_{Insu-3}$ (500 V), $I_{Cont}$ (three-phase), $I_{Cont weld.}$ (three-phase), functional test with $I_{PE}$ (three-phase), $U_{a weld.}$ (max. 80 V-AC / max. 80 V-DC / max. peak value 113 V)
3	Welding device of Class I, three-phase clamp	$R_{PE}$ (600 mA), $R_{Insu-1}$ (500 V), $R_{Insu-2}$ (250 V), $R_{Insu-3}$ (500 V), $I_{Cont}$ (dir.), $I_{Cont weld.}$ (dir.), functional test with $I_{PE}$ (clamp), $U_{a weld.}$ (max. 80 V-AC / max. 80 V-DC / max. peak value 113 V)

Table 38: Test procedures according to EN 60974-4 (VDE 0544-4) for Class I

Test no.	Name	Individual tests
1	Devices of Class III	$R_{Insu-1}$ (500 V), $R_{Insu-2}$ (250 V), $R_{Insu-3}$ (500 V), $I_{Cont weld.}$ (dir.), functional test with $I_{Cont}$ (diff.), $U_{a weld.}$ (max. 80 V-AC / max. 80 V-DC / max. peak value 113 V)

Table 39: Test procedures according to EN 60974-4 (VDE 0544-4) for Class II

## 13.2 Manual test procedures

Test / test no.	1	2	3	1
Protection class	Class I			Class II
Visual inspection	X	X	X	X
Connection test	X	X	X	X
$R_{PE}$ 600 mA	X	X	X	-
$R_{Insu-1} / R_{Insu-IN}$	X	X	X	X
$R_{Insu-2}$	X	X	X	X
$R_{Insu-3}$	X	X	X	X
$I_{Cont}$	X	X	X	-
$I_{Cont\ weld.}$	X	X	X	X
Funct.	X	X	X	X
$U_{a\ weld.}$	X	X	X	X

Table 40: Overview of test procedures according to EN 60974-4 (VDE 0544-4) for Class I (1 to 3) / Class II (1)

## 13.2 Manual test procedures

### 13.2.1 Manual test procedures according to EN 50678 (VDE 0701) and EN 50699 (VDE 0702)

Test	Class I	Class II	Class III
Visual inspection for visible defects: <ul style="list-style-type: none"> <li>Connecting cables / plug connections</li> <li>Housing, strain relief, protection against bending and kinking etc.</li> </ul>	X	X	X
Testing the protective conductor with regard to: Continuity between the earthing contact of the mains plug and accessible conductive parts of the device / the device connection	For cables with a rated current of $\leq 16.0$ A: For cables up to 5 m: $\leq 0.3 \Omega$ For additional meters (up to 7.5 m each), 0.1 $\Omega$ is added to the limit up to a maximum value of 1.0 $\Omega$ . For cables with higher rated currents, the calculated ohmic resistance value shall apply.	-	-
Measuring the insulating resistance	Generally: $\geq 1.0 M\Omega$ For proving safe isolation: $\geq 2.0 M\Omega$ For devices with heating elements: $\geq 0.3 M\Omega$ For devices with heating elements and a power of $> 3.5$ kW: $\geq 0.3 M\Omega$	$\geq 2 M\Omega$	$\geq 0.25 M\Omega$
Measuring the protective conductor current	$\leq 3.5$ mA on conductive components with PE connection: 1 mA/ kW to max. 10 mA for devices with heating elements and a total power of more than 3.5 kW	-	-

Test	Class I	Class II	Class III
Measuring the contact current	≤0.5 mA on conductive components without PE connection	≤0.5 mA	
Proving safe isolation (SELV, PELV) For devices generating a SELV or PELV voltage by means of an isolating transformer or a switch-mode power supply.	Proving the rated voltage: (compliance with specifications SELV/PELV)  Output voltage measurement (e. g. for chargers, mains supply units) with max. 25 V AC or 60 V DC for accessible active parts  Insulating resistance measurement (primary / secondary)  Insulating resistance measurement (between accessible conductive parts and active parts of the SELV / PELV circuit)		
Functional test	Functioning of protective equipment and functional test		
Analysis, evaluation, documentation	X		

Table 41: Manual test procedures according to EN 50678 (VDE 0701) and EN 50699 (VDE 0702)

### 13.2.2 Manual test procedures according to EN 62353 (VDE 0751-1)

Test	Class I	Class II
Visual inspection for visible defects: <ul style="list-style-type: none"> <li>• Connecting cables / plug connections</li> <li>• Housing, strain relief, protection against bending and kinking etc.</li> </ul>	X	X
Testing the protective conductor with regard to: Continuity between the earthing contact of the mains plug and accessible conductive parts of the device / the device connection	ME device without detachable mains connection cable: ≤ 0.3 Ω ME device with detachable mains connection cable: ≤ 0.2 Ω Detachable mains connection cable: ≤ 0.1 Ω Detachable mains connection cable + ME device: ≤ 0.3 Ω ME device with permanent connection: ≤ 0.3 Ω System with multiple socket: ≤ 0.5 Ω	-
Measuring the insulating resistance Insulation measurement must not be carried out if it is excluded in the accompanying documents according to the manufacturer's specifications.	LN to PE: ≥ 2.0 MΩ LN to accessible conductive parts without PE: ≥ 7.0 MΩ LN to secondary type B: ≥ 2.0 MΩ LN to secondary type F: ≥ 70.0 MΩ Secondary to PE type F: ≥ 70.0 MΩ	-  LN to accessible conductive parts without PE: ≥ 7.0 MΩ LN to secondary type B: ≥ 7.0 MΩ LN to secondary type F: ≥ 70.0 MΩ Secondary to PE type F: ≥ 70.0 MΩ
Measuring the leakage currents		

Test	Class I			Class II		
Device leakage current:	Type B $\leq 1\,000\ \mu\text{A}$	Type BF $\leq 1\,000\ \mu\text{A}$	Type CF $\leq 1\,000\ \mu\text{A}$	Type B $\leq 500\ \mu\text{A}$	Type BF $\leq 500\ \mu\text{A}$	Type CF $\leq 500\ \mu\text{A}$
Alternative leakage current measuring method	A	A				
Direct / differential current measuring method	$\leq 500\ \mu\text{A}$	$\leq 500\ \mu\text{A}$	$\leq 500\ \mu\text{A}$	$\leq 100\ \mu\text{A}$	$\leq 100\ \mu\text{A}$	$\leq 100\ \mu\text{A}$
Patient leakage current:	-	$\leq 5\,000\ \mu\text{A}$	$\leq 50\ \mu\text{A}$	-	$\leq 5\,000\ \mu\text{A}$	$\leq 50\ \mu\text{A}$
Alternative leakage current measuring method (AC)	-	A	$\leq 50\ \mu\text{A}$	-	$\leq 5\,000\ \mu\text{A}$	$\leq 50\ \mu\text{A}$
Direct current measuring method (AC)		$\leq 5\,000\ \mu\text{A}$			$\leq 5\,000\ \mu\text{A}$	
		A				
Functional test	Functioning of safety equipment and functional test					
Analysis, evaluation, documentation	(Inspection and preparation for intended use)					

Table 42: Manual test procedures according to EN 62353 (VDE 0751-1)

### 13.2.3 Manual test procedures according to EN 60974-4 (VDE 0544-4)

Test	Class I	Class II
Visual inspection for visible defects: <ul style="list-style-type: none"> <li>• Torch / electrode holder</li> <li>• Mains supply</li> <li>• Welding circuit</li> <li>• Housing etc.</li> </ul>	X	X
Testing the protective conductor with regard to: Continuity between the earthing contact of the mains plug and accessible conductive parts of the device / the device connection	For cables with a rated current of $\leq 16.0\ \text{A}$ :  For cables up to 5 m: $\leq 0.3\ \Omega$ For additional meters (up to 7.5 m each), 0.1 $\Omega$ is added to the limit up to a maximum value of 1.0 $\Omega$ .  For cables with higher rated currents, the calculated ohmic resistance value shall apply.	-
Measuring the insulating resistance	Mains circuit to welding circuit: $\geq 5.0\ \text{M}\Omega$  Welding circuit to protective conductor circuit: $\geq 2.5\ \text{M}\Omega$  Mains circuit to protective conductor circuit: $\geq 2.5\ \text{M}\Omega$	Mains circuit to welding circuit: $\geq 5.0\ \text{M}\Omega$  Mains circuit to accessible surfaces: $\geq 5.0\ \text{M}\Omega$

Test	Class I	Class II
Contact current of the welding circuit Welding outputs to protective conductor connection	Alternating current R.m.s. value $\leq 10.0$ mA	R.m.s. value $\leq 10.0$ mA
Contact current during normal operation for accessible conductive surfaces which are not connected to the protective conductor circuit	R.m.s. value $\leq 0.5$ mA	R.m.s. value $\leq 0.5$ mA
Protective conductor current	R.m.s. value $\leq 10.0$ mA	-
Open-circuit voltage <ul style="list-style-type: none"> <li>Environment with increased electrical hazard</li> <li>Environment without increased electrical hazard</li> </ul>	The $U_0$ peak values must be $\leq U_0 \times 1.15$ and the values stated in IEC 60974-1 must not be exceeded. <ul style="list-style-type: none"> <li>113 V-DC peak value, 68 V-AC peak value, 48 V-AC r.m.s. value</li> <li>113 V-DC peak value, 113 V-AC peak value, 80 V-AC r.m.s. value</li> </ul>	
Functional test	Functioning of safety equipment and functional test	
Analysis, evaluation, documentation	Inspection and preparation for intended use. Welding equipment not constructed in compliance with EN/ IEC 60974-1 might not meet all the requirements of this standard. In this case, specify the following in the test report: <ul style="list-style-type: none"> <li>Requirements not met</li> <li>Extent of the requirements not met</li> <li>Risk assessment to be concluded</li> <li>Corrective measures</li> </ul> The test report shall enable the owner to make an appropriate decision on the further use of the device.	

Table 43: Manual test procedures according to EN 60974-4 (VDE 0544-4)

## 13.3 Test standards

The content of this operating manual is intended to describe the appliance tester and in no way replaces the currently applicable test standards.

	EN 50678 (VDE 0701), EN 50699 (VDE 0702)	EN 62353 (VDE 0751-1)	EN 60974-4 (VDE 0544-4)
<b>Device type</b>	<ul style="list-style-type: none"> <li>Firmly connected electrical devices</li> <li>Portable electrical devices</li> <li>Electrical equipment of non-electrical devices</li> <li>Portable electrical protective devices (PRCDs)</li> </ul>	<ul style="list-style-type: none"> <li>Firmly connected medical electrical devices / systems</li> <li>Portable medical electrical devices / systems</li> </ul>	<ul style="list-style-type: none"> <li>Firmly connected arc welding equipment</li> <li>Portable arc welding equipment</li> </ul>

Table 44: Overview of test standards

Test step	EN 50678 (VDE 0701), EN 50699 (VDE 0702)	EN 62353 (VDE 0751-1)	EN 60974-4 (VDE 0544-4)
Visual inspection	X	X	X
Protective conductor resistance	X	X	X
Insulating resistance	X	X (optional)	X
Protective conductor current	X	X	-
Contact current	X	X	X
Patient leakage current	-	X	-
Device leakage current	-	X	-
Open-circuit voltage	-	-	X
Safe isolation from power supply circuit (SELV / PELV)	X	-	-
Effectiveness of further protective equipment	X	X	X
Inspection of markings	X	X	X
Functional test	X	X	X
Analysis, evaluation, documentation	X	X	X

Table 45: Overview of test steps

For testing, the following provisions, regulations and standards shall be authoritative:

- EN 50678 (VDE 0701)
- EN 50699 (VDE 0702)
- EN 62353 (VDE 0751-1)
- EN 60974-4 (VDE 0544-4)
- BetrSichV (German health and safety at work regulation)
- TRBS 1201 (German technical guideline for operational safety)
- TRBS 1203 (German technical guideline for operational safety)
- DGUV Regulation 3 (German accident prevention regulation)

## 13.4 Factory settings and measured values

### 13.4.1 Factory settings and measured values – Protective conductor resistance tests

Test	Value	Unit
R <sub>PE</sub> VDE 0701/0702	0.3	Ω
R <sub>PE</sub> VDE 0751-1	0.3	Ω
R <sub>PE</sub> VDE 0544-4	0.3	Ω

Table 46: Factory settings of the limits for protective conductor resistance tests (conductor 5 m, 1.5 mm<sup>2</sup>)

Parameter	Value
Testing current	600 mA-AC ±30 % at 0 ... 5 Ω
	10 A-AC ±30 % at 0 Ω
Testing voltage	U <sub>0</sub> approx. 8 V-AC

Parameter	Value
Measuring range	0.05 ... 10 Ω
Resolution	0.001 Ω
Accuracy	±15 % of the measured value

Table 47: Measured values according to measuring specifications – Protective conductor resistance tests

## 13.4.2 Factory settings and measured values – Insulating resistance tests

Test	Value	Unit
R <sub>Insu-1</sub> VDE 0701/0702, Class I, LN to PE	1.00	MΩ
R <sub>Insu-1</sub> VDE 0701/0702, Class II, LN to test body	2.00	MΩ
R <sub>Insu-1</sub> VDE 0701/0702, Class III, input to test body	0.25	MΩ
R <sub>Insu-1</sub> VDE 0751-1, Class I, LN to PE	2.00	MΩ
R <sub>Insu-1</sub> VDE 0751-1, Class II, LN to test body	7.00	MΩ
R <sub>Insu-1</sub> VDE 0544-4, Class I, LN to PE	2.50	MΩ
R <sub>Insu-1</sub> VDE 0544-4, Class II, LN to test body	5.00	MΩ
R <sub>Insu-2</sub> VDE 0701/0702, Class I, secondary to PE	0.25	MΩ
R <sub>Insu-2</sub> VDE 0701/0702, Class II, secondary to test body	0.25	MΩ
R <sub>Insu-2</sub> VDE 0701/0702, Class III, output to test body	0.25	MΩ
R <sub>Insu-2</sub> VDE 0751-1, Class I, secondary to PE	70.00	MΩ
R <sub>Insu-2</sub> VDE 0751-1, Class II, secondary to test body	70.00	MΩ
R <sub>Insu-2</sub> VDE 0544-4, Class I, secondary to PE	2.50	MΩ
R <sub>Insu-2</sub> VDE 0544-4, Class II, secondary to test body	2.50	MΩ
R <sub>Insu-3</sub> VDE 0701/0702, Class I, LN to secondary	2.00	MΩ
R <sub>Insu-3</sub> VDE 0701/0702, Class II, LN to secondary	2.00	MΩ
R <sub>Insu-3</sub> VDE 0701/0702, Class III, input to output	0.25	MΩ
R <sub>Insu-3</sub> VDE 0751-1, Class I, LN to secondary, type B	2.00	MΩ
R <sub>Insu-3</sub> VDE 0751-1, Class I, LN to secondary, type BF	70.00	MΩ
R <sub>Insu-3</sub> VDE 0751-1, Class I, LN to secondary, type CF	70.00	MΩ
R <sub>Insu-3</sub> VDE 0751-1, Class II, LN to secondary, type B	7.00	MΩ
R <sub>Insu-3</sub> VDE 0751-1, Class II, LN to secondary, type BF	70.00	MΩ
R <sub>Insu-3</sub> VDE 0751-1, Class II, LN to secondary, type CF	70.00	MΩ
R <sub>Insu-3</sub> VDE 0544-4, Class I, LN to secondary	5.00	MΩ
R <sub>Insu-3</sub> VDE 0544-4, Class II, LN to secondary	5.00	MΩ
R <sub>Insu-4</sub> VDE 0701-0702, Class I, LN to access. parts without PE	2.00	MΩ
R <sub>Insu-4</sub> VDE 0751-1, Class I, LN to access. parts without PE	7.00	MΩ
R <sub>Insu-4</sub> VDE 0544-4, Class I, LN to access. parts without PE	5.00	MΩ

Table 48: Factory settings of the limits for insulating resistance tests

Parameter	Value
Testing voltage	100 ... 500 V-DC (-0 % / +25 %) at a testing current of 0 ... 1 mA
	501 ... 1 000 V-DC (-12 % / +25 %) at a testing current of 0 ... 1 mA



## 13.4 Factory settings and measured values

Parameter	Value
Testing current	>1 mA at 500 k $\Omega$ and 500 V-DC
	<5 mA at 0 $\Omega$ and 500 V-DC
	<7 mA at 0 $\Omega$ and 1 000 V-DC
Measuring range	0.10 ... 100 M $\Omega$
Resolution	0.01 M $\Omega$
Accuracy	$\pm 15$ % of the measured value

Table 49: Measured values according to measuring specifications – Insulating resistance tests

### 13.4.3 Factory settings and measured values – Current measuring method

Test	Value	Unit
$I_{PE}$ VDE 0701/0702, devices in general	3.5	mA
$I_{PE}$ VDE 0701/0702, with heating elements >3.5 kW	1.0 (max. 10 mA)	mA/kW
$I_{PE}$ VDE 0544-4, Class I	10.0	mA

Table 50: Factory settings of the limits for protective conductor current test

Test	Value	Unit
$I_{Cont}$ VDE 0701/0702	0.5	mA
$I_{Cont}$ VDE 0544-4	0.5	mA
$I_{Cont}$ VDE 0544-4 welding output	10.0	mA

Table 51: Factory settings of the limits for contact current test

Test	Value	Unit
$I_{Leak}$ VDE 0751-1, Class I	0.5	mA
$I_{Leak}$ VDE 0751-1, Class II	0.1	mA
$I_{PLeak}$ VDE 0751-1, Class I, AC, type BF	5.00	mA
$I_{PLeak}$ VDE 0751-1, Class I, AC, type CF	0.05	mA
$I_{PLeak}$ VDE 0751-1, Class I, DC, type BF	0.01	mA
$I_{PLeak}$ VDE 0751-1, Class I, DC, type CF	0.01	mA
$I_{PLeak}$ VDE 0751-1, Class II, AC, type BF	5.00	mA
$I_{PLeak}$ VDE 0751-1, Class II, AC, type CF	0.05	mA
$I_{PLeak}$ VDE 0751-1, Class II, DC, type BF	0.01	mA
$I_{PLeak}$ VDE 0751-1, Class II, DC, type CF	0.01	mA

Table 52: Factory settings of the limits for leakage current test

Parameter	Value
Measuring range	0.03 ... 25 mA
Resolution	0.001 mA
Accuracy	$\pm 15$ % of the measured value
Internal resistance (measuring instrument / probe)	VDE 0701/0702: $R_i = 1$ k $\Omega$
	VDE 0751-1: $R_i = 1$ k $\Omega$
	VDE 0544: $R_i = 2$ k $\Omega$

Table 53: Protective conductor resistance – Alternative leakage current measuring method

Parameter	Value
Measuring range	0.05 ... 25 mA

Parameter	Value
Resolution	0.001 mA
Accuracy	±15 % of the measured value
Internal resistance	$R_i = 0 \Omega$

Table 54: Measured values according to measuring specifications – Differential current measuring method

Parameter	Value
Measuring range	0.03 ... 25 mA
Resolution	0.001 mA
Accuracy	±15 % of the measured value
Internal resistance (measuring instrument / probe)	VDE 0701/0702: $R_i = 1 \text{ k}\Omega$
	VDE 0751-1: $R_i = 1 \text{ k}\Omega$
	VDE 0544: $R_i = 2 \text{ k}\Omega$

Table 55: Measured values according to measuring specifications – Direct current measuring method

### 13.4.4 Factory settings and measured values – Functional test

Parameter	Value
Nominal voltage	230 V ±10 % (mains feed-in is switched to the test socket)
Rated current	16 A
Measuring range	0.0 ... 270 V-AC (50 / 60 Hz) 0.10 ... 20 A-AC (50 / 60 Hz) 20 ... 2.3 kW (effective power) 20 ... 2.3 kVA (apparent power)
Resolution	0.1 V 0.001 A 0.1 W 0.1 VA
Accuracy	U (V) = ±15 % of the measured value I (A) = ±15 % of the measured value P (W) = ±20 % of the measured value S (VA) = ±20 % of the measured value at $\cos \phi = 0.8$

Table 56: Measured values according to measuring specifications – Functional test

### 13.4.5 Factory settings and measured values – Cable continuity test

Parameter	Value	Unit
Line length	5.0	m
Line cross-section	1.5	mm <sup>2</sup>
Number of conductors	3	-
Resistance per conductor	0.3	$\Omega$

Table 57: Factory settings of the limits for cable continuity test

Parameter	Value
Testing current	600 mA-AC ±30 % at 0 ... 5 $\Omega$

## 13.4 Factory settings and measured values

Parameter	Value
Measuring range	0.05 ... 10 $\Omega$
Resolution	0.001 $\Omega$
Accuracy	$\pm 15$ % of the measured value
Measuring voltage	$U_0$ approx. 8 V-AC

Table 58: Measured values according to measuring specifications – Cable continuity test

### 13.4.6 Factory settings and measured values – Safety extra-low voltage test

Parameter	Value
Measuring range	1.0 ... 360 V-DC, 250 V-AC
Resolution	0.1 V
Accuracy	$\pm 15$ % of the measured value

Table 59: Measured values according to measuring specifications – Safety extra-low voltage test

### 13.4.7 Factory settings and measured values – PRCD test

Parameter	Value	Unit
Tripping current I nom.	30	mA
Tripping time 1 x I nom.	300	ms
Tripping time 5 x I nom.	40	ms
Tripping time $\frac{1}{2}$ x I nom.	300	ms

Table 60: Factory settings of the limits for PRCD-AC

Parameter	Value	Unit
Tripping current I nom.	42	mA
Tripping time 1 x I nom.	300	ms
Tripping time 5 x I nom.	40	ms
Max. contact voltage	35	V

Table 61: Factory settings of the limits for PRCD-A und PRCD-F

Parameter	Value	Unit
Tripping current I nom.	60	mA
Tripping time 1 x I nom.	300	ms
Tripping time 5 x I nom.	40	ms
Max. contact voltage	50	V

Table 62: Factory settings of the limits for PRCD-B und PRCD-B+

Parameter	Value	Unit
Tripping current I nom.	30	mA
Tripping time 1 x I nom.	300	ms
Tripping time 5 x I nom.	40	ms
Max. contact voltage	25	V

Table 63: Factory settings of the limits for PRCD 2-pin, 3-pin, K, S and S+

Parameter	Value
Testing current	0 ... 100 mA, 100 ... 1 000 mA

Parameter	Value
Types of current	Sinusoidal, DC +/-, half-wave 0° and 180°
Accuracy	<ul style="list-style-type: none"> <li>• Tripping fault current: 0 ... 10 % (<math>I_n</math>, 5 x <math>I_n</math>)</li> <li>• Non-tripping fault current: -10 ... 0 % (<math>I_n/2</math>)</li> <li>• Tripping time: ±10 % of the maximum admissible tripping time</li> </ul>

Table 64: Measured values according to measuring specifications – PRCD

### 13.4.8 Factory settings and measured values – Voltage of the welding circuit test

Parameter	Value	Unit
U <sub>a</sub> VDE 0701/0702, max. output voltage	25	V
U <sub>a</sub> weld. VDE 0544-4, max. output voltage AC	80	V
U <sub>a</sub> weld. VDE 0544-4, max. output voltage DC	80	V
U <sub>a</sub> weld. VDE 0544-4, max. peak value	113	V

Table 65: Factory settings of the limits for voltage of the welding circuit test

Parameter	Value
Measuring range	10 ... 200 V-DC, 140 V-AC
Resolution	0.1 V
Accuracy	±2.5 % of the final measuring range value

Table 66: Measured values according to measuring specifications – Voltage of the welding circuit test

### 13.4.9 Factory settings and measured values – Times

Parameter	Value	Unit
Test times for individual tests	5	s
Default delay time (mains pole reversal)	0	ms

Table 67: Factory settings of the limits for times

## 13.5 Measuring methods

### Differential current measuring method

The connections on the mains side of the test sample are checked by a differential current transformer. To do this, the total current and differential current of all currents flowing in and out of the test sample are measured. If there is a current difference between the L and N conductors, a leakage or fault current is proven to flow. If leakage or fault currents flow off via different fault points, they cannot be detected individually.

### Direct current measuring method

The leakage current is measured directly via a measuring resistor (shunt). For test samples that are not placed onto an insulated surface, leakage currents can flow off via parallel earth connections. This reduces the measured leakage current and results in incorrect measuring results.

### Alternative leakage current measuring method

The measuring circuit for the alternative leakage current measuring method is galvanically isolated from the mains and the L and N conductors are bridged. By default, the potential-free testing voltage is 230 V-AC. In case of a different testing voltage, the measured leakage current is converted to correspond to a test result with mains voltage.

The measuring method may only be used after the insulation test has been passed and if there are no mains voltage-dependent electrically operated switching devices in the test sample.

### DGUV Information 203-070

“Wiederkehrende Prüfungen ortsveränderlicher elektrischer Arbeitsmittel – Fachwissen für Prüfpersonen” (Periodic inspections of portable electrical equipment – Expert knowledge for testing personnel):

<https://publikationen.dguv.de/regelwerk/dguv-informationen/246/wiederkehrende-pruefungen-ortsveraenderlicher-elektrischer-arbeitsmittel-fachwissen-fuer-pruefpersonen>

### DGUV Information 203-071

“Wiederkehrende Prüfungen ortsveränderlicher elektrischer Arbeitsmittel – Organisation durch den Unternehmer” (Periodic inspections of portable electrical equipment – Organisation by the entrepreneur):

<https://publikationen.dguv.de/regelwerk/dguv-informationen/787/wiederkehrende-pruefungen-elektrischer-anlagen-und-betriebsmittel-organisation-durch-den-unternehme>

## 13.6 Remote control

### 13.6.1 Remotely controlling the device via the PC

#### Requirements

- The PC software “CerHost” [▶ page 19] is installed on your PC.
- The device is switched on and you are logged in as a user.
- DHCP is enabled on the device in the "LAN-IPv4" settings and on the PC.

#### Menu

“Settings > System settings > Network > LAN-IPv4”

“Settings > System settings > Network > Remote control”

#### Procedure

1. Open the PC software “CerHost”.
2. Open the "File" tab.
3. Start the remote control on the device. To do this, tap the “Remote control” button in the network settings.
4. Tap the "Connect" button to detect the device.  
The "Connect" window opens.
5. Wait until your device (efusA9...) is displayed and select it.

The connection will be established automatically. As soon as the connection is established, the device screen is displayed in the “CerHost” window. Now, you can control the device remotely via the display.

If the connection is not established, check your network settings as well as the access rights of your network.

If connection interruptions occur during image transmission, the manufacturer recommends increasing the refresh duration [ms].

## 13.6.2 Remotely controlling the device using a smartphone or tablet

### Requirements

- The “CerHost” app [▶ page 19] is installed on your end device (e. g. smartphone or tablet).
- The device is switched on and you are logged in as a user.
- DHCP is enabled on the device in the "WLAN-IPv4" settings.
- The following network information of the device is available:
  - Host name
  - IP address

### Menu

“Settings > System settings > Network > WLAN-IPv4”

“Settings > System settings > Network > Remote control”

### Procedure

1. Enable the WLAN hotspot on your end device.
2. Connect the device to your WLAN hotspot [▶ page 59].
3. Open the “CerHost” app on your end device.
4. Create a new “Device”. To do this, tap the “+” symbol, enter the “Host name” and the IP address of the device and save the information with the “SAVE” button.
5. Enable the remote control on the device. To do this, tap the “Remote control” button in the network settings and confirm the “Warning” window displayed by tapping the “Yes” button.
6. Select the created "Device" and tap the “View” button.  
The connection will be established automatically.  
If the connection is not established, check your network settings as well as the access rights of your WLAN hotspot.

# Index

## Numerical

3-Phasig	50
7-Zoll-Display	
Anzeigebereich	23
Bildschirmaufbau	23
Fußzeile	24
Kopfzeile	23

## A

Abwärtskompatibilität	35
Accessories	18
Allgemeine Bedienung	27, 29
Ändern	67
Anmelden	
Benutzer	28
Anschlussstest	40
Anzeige	70
Aufwärtskompatibilität	35
Ausschalten	27
Auswählen	65
Automatik	
Automatikprüfung	39, 76

## B

Barcodescanner	51
Cordless	52
Funk	52
Basic knowledge	11
Batterie	22
BENNING CM 9-1	51
BENNING CM 9-2	51
BENNING MA 2-16	50
BENNING MA 3	50
BENNING MA 4	49
BENNING PC Win ST 750-760	
Protokoll Software	35
BENNING ST 755+	10
BENNING ST 760+	10
Benutzerrollen	36
Benutzerverwaltung	64
Zugriffsberechtigung	36
Berührungsstrom	44, 84
Schweißstromkreis	47, 94

## C

Calibrating	97
Cleaning	97
Copyright	2

## D

Datenbank	
-----------	--

Inhalte	34
Verwalten	65
Datensicherung	35
Declaration of conformity	12
Device	
Calibrating	97
Cleaning	97
Securing	16
DGUV-Information 203-070	117
DGUV-Information 203-071	117
Differenzstrom-Messverfahren	117
Direkt-Messverfahren	117
Disclaimer	2, 15
Disposal	101
Packaging	101
Documentation	2
Drawings	11
Drittanbieter-Software	19
Drucker	54

## E

Einschalten	27
Einzelprüfungen	79
Environmental protection	101
Ersatzableitstrom-Messverfahren	117
Experteneinstellungen	36
Kundenspezifische Grenzwerte	36
Kundenspezifische Prüfabläufe	36
Kundenspezifische Sichtprüfung	36
Updates	36
Werkseinstellungen	36

## F

Fehlerstrom-Schutzeinrichtung	95
PRCD	47
Figures	11
Funktion prüfen	90
Funktionsprüfung	45
Further information	10

## G

Geräteableitstrom	44, 86
Gerätedaten	
Information	42
Prüflingeigenschaften	58
Grenzwerte	



Ableitstrom	113	Manuelle Prüfungen	77
Berührungsstrom	113	Manufacturer	2
Differenzstrom-Messverfahren	114	Measurement	
Direkt-Messverfahren	114	Requirements	71
Ersatzableitstrom-Messverfahren	113	Messadapter	50
Isolationswiderstand	112		
Kabeldurchgang	114	<b>N</b>	
PRCD	115	Naming convention	10
Schutzleiterstrom	113	Netzwerkeinstellungen	58
Schutzleiterwiderstand	111	Neu	
Spannung Schweißstromkreis	116	Anlegen	65
Speichern	37	Non-discrimination	2
Überschreiben	37		
Zeiten	116		
Zurücksetzen	37		
		<b>P</b>	
<b>H</b>		Packaging	101
History	12	Passwort	
Holder of rights	2	Wiederherstellen	99
		Patientenableitstrom	45, 88
<b>I</b>		PELV	46
IAbl.	86	PRCD	95
IBER	84	Prüfabläufe	61
Ident.-Nr.	66	Prüfansicht	
Intended use	15	Schaltflächen bedienen	31
IPAbI.	88	Prüfling	
IPE	83	Ändern	67
Isolationswiderstand	43, 82	Auswählen	67
		Kopieren	68
		Löschen	68
		Prüfling Neu anlegen	66
		Prüflinge	
		Gerät	66
		Prüfnormübersicht	110
		Prüfplatzwechsel	22
		Purpose of the operating manual	11
		<b>R</b>	
		Recycling	
		Packaging	101
		Return address	12
		Returns management	12
		RFID-Scanner	53
		RISO	82
		RPE	80
		<b>S</b>	
		Safety measuring lines	
		Connecting	74
		Schaltflächen	
		Fußzeile	29
		Schutzkleinspannung	46
		Schutzleiterstrom	44, 83
		Schutzleiterwiderstand	42, 80
		Scope of delivery	18
		Securing	16
		SELV	46
		Service & Support	
<b>K</b>			
Kabeldruchgangsprüfung	46		
Kalibrierung			
Kabelabgleich	69		
Nullabgleich	69		
Sondenabgleich	69		
Kopieren	68		
Kundenspezifische Gerätevorlagen	37, 63		
Kundenspezifische Grenzwerte	36, 60		
Kundenspezifische Prüfabläufe	37		
Kundenspezifische Prüfabläufe	61		
Kundenspezifische Prüflingsvorlagen	63		
Kundenspezifische Sichtprüfung	37, 61		
<b>L</b>			
Leckstromzange	51		
Liste	30		
Listenansicht	30		
Löschen	68		
<b>M</b>			
MA 2-16	50		
MA 3	50		
MA 4	49		
Maintenance	96		
Maintenance schedule	96		

Technical Support	12
Sicherungskopien	35
Sichtprüfung	41
Erweiterte Sichtprüfung	41
Kundenspezifische Sichtprüfung	41
Standard Sichtprüfung	41
Smart Menü	33
Spannung	
Schweißstromkreis	93
Spannung Schweißstromkreis	46
Spannungsfreiheit	96
Sprache	70
ST 755+	10
ST 760+	10
Standards applied	13
Statusmeldung	30
Storage	20
Stromverteiler	48
Symbols	
Device	14
Systemdaten	56
Systemeinstellungen	56

## T

Target group	11
Tastatur	55
Technical Support	12
Technische Daten	100
Test	
Requirements	71
Testergebnis	
Prüfprotokoll	32
Testzeit	41
Trademarks	12
Transportieren	20
Typenschild	22

## U

Überfällige Prüflinge	
Überfällige Geräte	39
Uhrzeit	70
Umpolung der Prüfspannung	41
Umpolzeit	
Netzumpolung	40
Update	
Firmware	38, 98
GUI	38, 98

## V

Verpackung	20
Vorlagen	38, 63

## W

Warning system	13
Warranty	15
WLAN	

Netze	59
-------	----

## Z

Zubehör	
Barcodescanner	51
Drucker	54
RFID-Scanner	53
Tastatur	55



# BENNING

BENNING Elektrotechnik und Elektronik GmbH & Co. KG  
Münsterstraße 135 - 137  
D - 46397 Bocholt  
Phone: +49 2871 93-0 Fax: +49 2871 93-429  
Internet: [www.benning.de](http://www.benning.de) E-Mail: [duspol@benning.de](mailto:duspol@benning.de)

The text and illustrations correspond to the state of technology at the time of printing. Subject to technical changes. No liability accepted for printing errors.