

## Montageanleitung

Ⓒ mounting instruction Ⓕ Notice de montage Ⓒ Instrukcja montażu  
Ⓔ Instrucciones de montaje Ⓖ Istruzioni di montaggio

EBRE-LED ... .SD / .SR  
EBRME-LED ... .SD / .SR



RIDI Leuchten GmbH  
Hauptstrasse 31 - 33 · D-72417Jungingen  
Tel. 07477/872-0 · Fax 07477/872-48  
kontakt@ridi.de · www.ridi.de



- Ⓓ Für die Installation und für den Betrieb der Leuchten sind die nationalen Sicherheitsvorschriften zu beachten.
- ⒼⒸ Please note national safety instructions for installation and operation of this luminaire.
- Ⓕ Pour l'installation et le fonctionnement des luminaires il est impératif de respecter les normes nationales de sécurité en vigueur.
- Ⓗ W celu prawidłowej instalacji i poprawnego działania oprawy należy przestrzegać krajowych przepisów bezpieczeństwa.
- Ⓔ Para la instalación y la puesta en funcionamiento de las luminarias deben observarse las normas nacionales de seguridad.

- Ⓓ Verwendung der Leuchte in einer Umgebung, in der eine Ablagerung von nichtleitfähigem Staub auf der Leuchte erwartet werden kann.
- ⒼⒸ Using of the luminaire in an environment where a non-conductive deposition of dust on the luminaire is to be expected.
- Ⓕ Utilisation du luminaire dans un environnement où un dépôt de poussière non-conductrice peut être attendu.
- Ⓗ Oprawa może być używana w otoczeniu, w którym występuje kurz. Nie powoduje elektryzowania się kurzu.
- Ⓔ Uso de la luminaria en un entorno en el que pueda producirse una acumulación de polvo no conductivo sobre la misma.

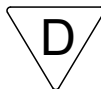

8/10

- Ⓓ Die Lichtquelle dieser Leuchte darf nur vom Hersteller oder einem von ihm beauftragten Servicetechniker oder einer vergleichbar qualifizierten Person ersetzt werden.
- ⒼⒸ Only the manufacturer, a trained service technician or another equally qualified person is permitted to replace the light source of this luminaire.
- Ⓕ La source lumineuse de ce luminaire ne peut être remplacée que par le fabricant, un technicien de service mandaté par celui-ci ou une personne présentant une qualification analogue.
- Ⓗ Wymiany źródła światła w tej oprawie oświetleniowej może dokonać wyłącznie producent bądź uprawniony pracownik serwisu albo osoba o podobnych kwalifikacjach.
- Ⓔ La fuente de luz de esta luminaria solamente podrá ser sustituida por el fabricante o una persona designada por este, ya sea un técnico de servicio u otra persona debidamente cualificada.
- Ⓘ La sorgente luminosa di tale lampada può essere sostituita solo dal produttore o da un tecnico di assistenza da questi designato oppure da personale dotato di qualifica equivalente.

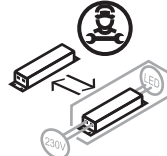

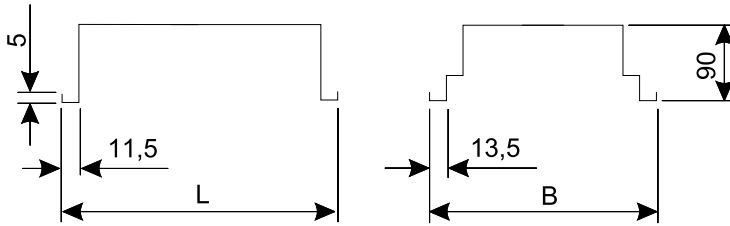

TYP	L	B	LE	BE	LS	BS
EBRE-LED 236 ...	1247	310	1229	292	1250	312,5
EBRE-LED 418 ...	622	622	604	604	625	625
EBRE-LED 414 ...	622	622	604	604	625	625
EBRME-LED 236 ...	1197	297	1179	279	1200	300
EBRME-LED 418 ...	597	597	579	579	600	600
EBRME-LED 414 ...	597	597	579	579	600	600

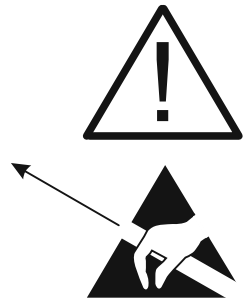
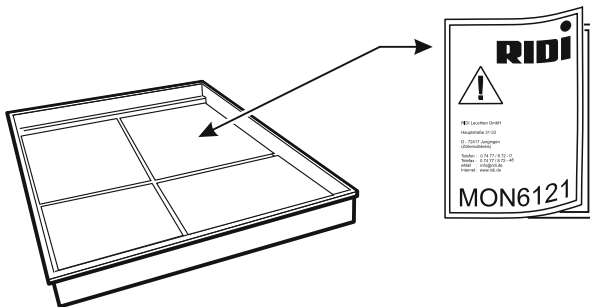
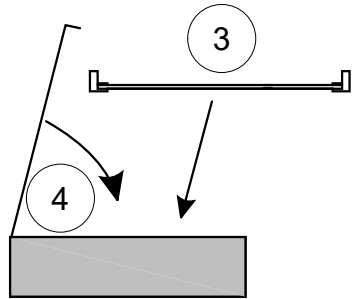
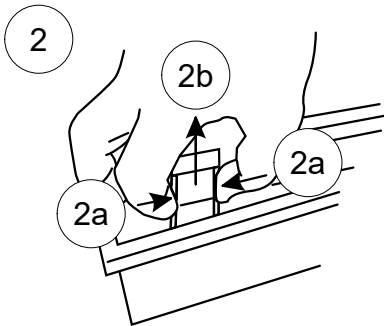
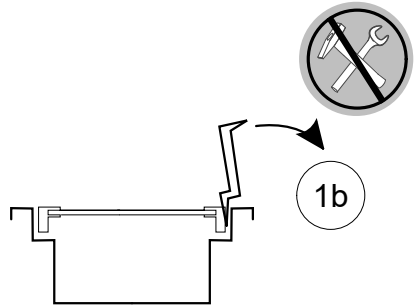
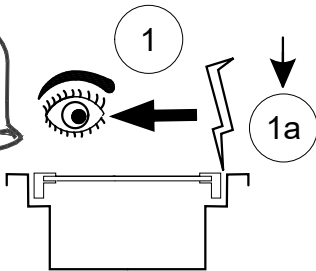
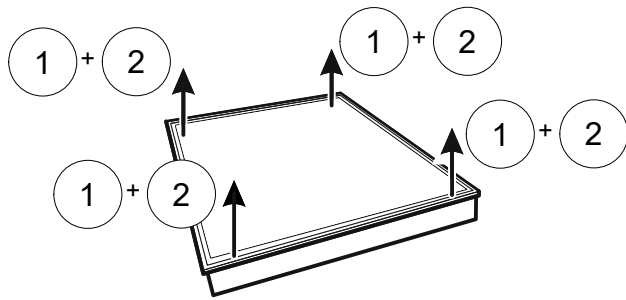

EBRE  
EBRME

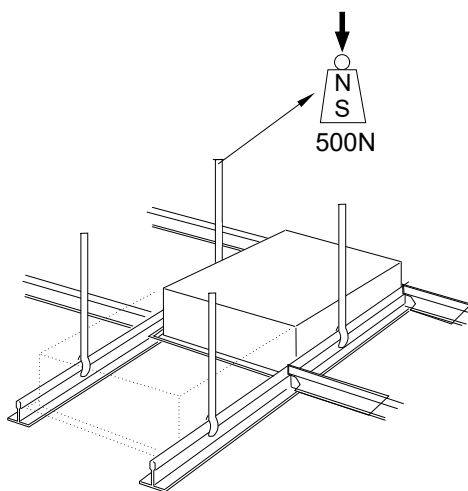
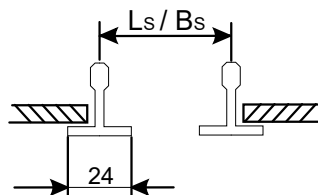
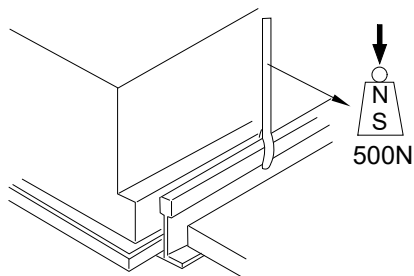
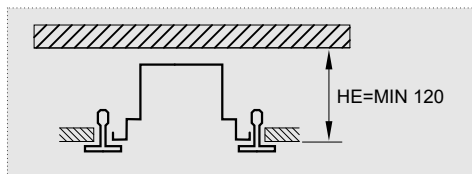

EBRE  
EBRME

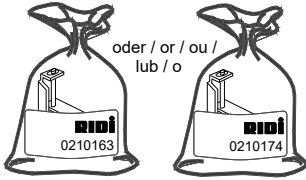
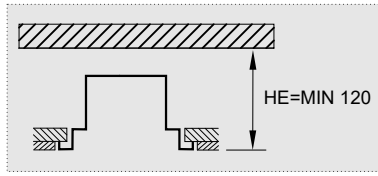

oder / or / ou /  
lub / o

3/10

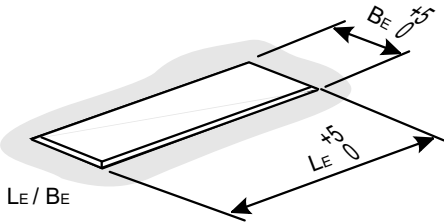

← LE / BE

0210163  $\hat{=}$  H<sub>k</sub> MIN 23 MAX 55  
0210174  $\hat{=}$  H<sub>k</sub> MIN 45 MAX 80

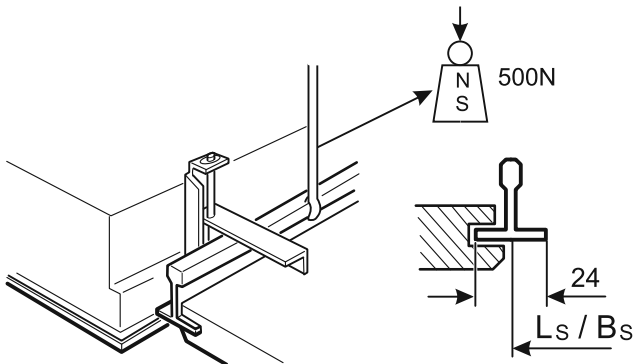
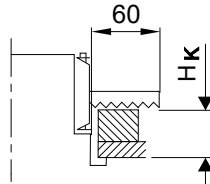
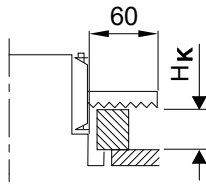
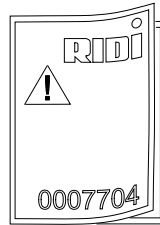
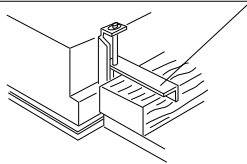

EBRE  
EBRME

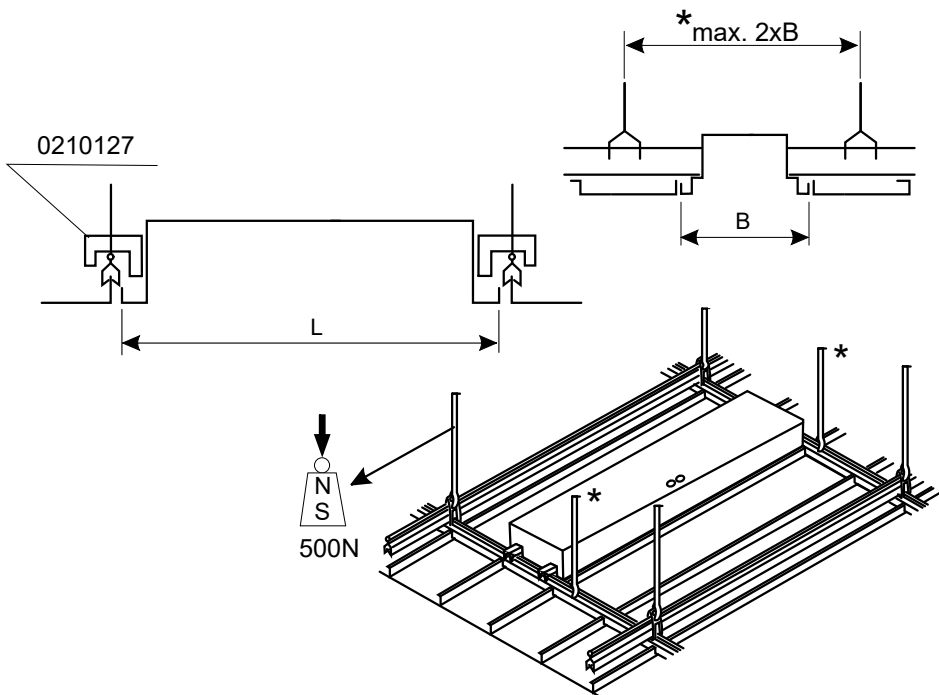
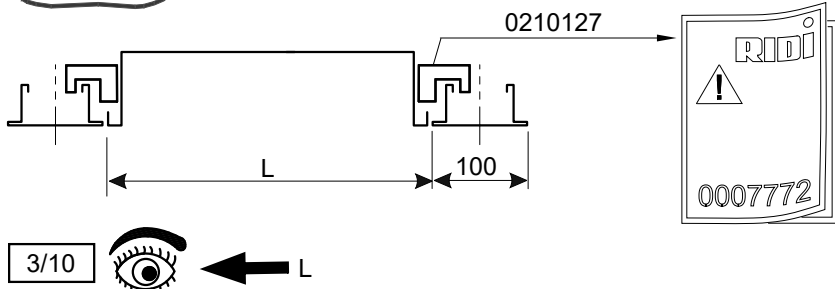
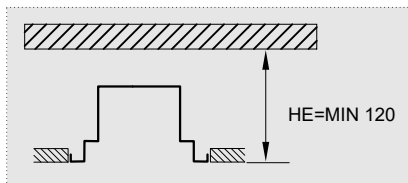

Keine Isolierung  
 No insulation  
 Pas d'isolation  
 Brak izolacji  
 Sin aislamiento  
 Nessun isolamento

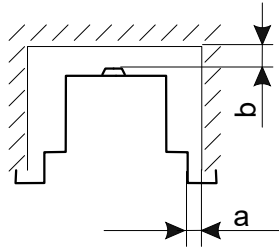
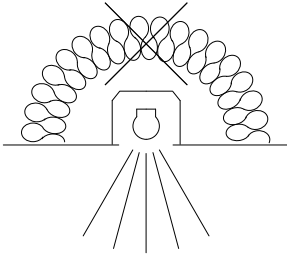

$a_{min} = 60 \text{ mm}$

$b_{min} = 30 \text{ mm}$

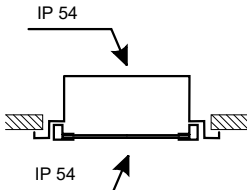

.SD

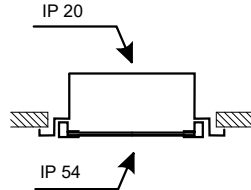
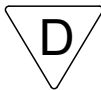

.SR

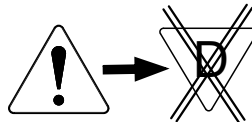



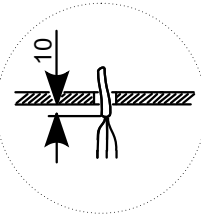
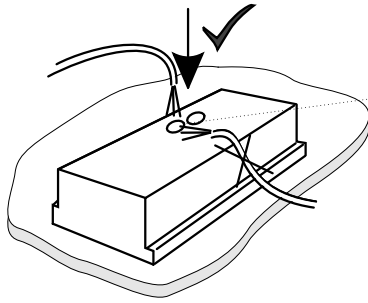

VOLT ?

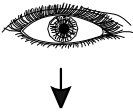

**RIDI** .....  
 ~ ...V/...Hz

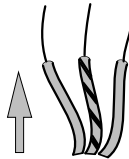

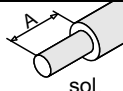
	mm <sup>2</sup>	A
sol.	0,5-1,0	9
	0,5-2,5mm <sup>2</sup>	12

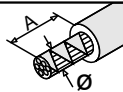
	Ø	A
	0,8-1,2	9
max. ø1,8mm	1,3-1,8	12

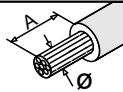
	Ø	A
	0,8-1,2	9
max. ø1,8mm	1,3-1,8	12

optional

