

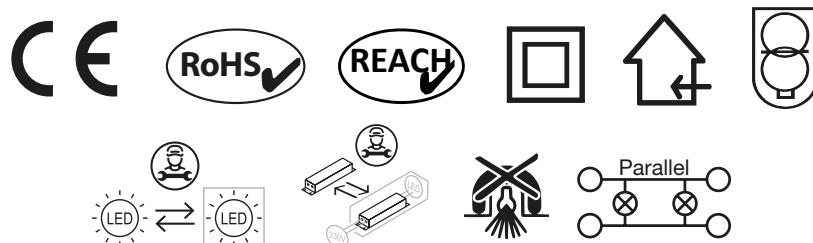



# TALAN XL, IP44, 27/30/4000K TALAN XL, IP44, 27/30/4000K

48503

## MONTAGE- UND BETRIEBSANLEITUNG MOUNTING AND OPERATING INSTRUCTIONS



## SICHERHEITSHINWEISE:

-  **Stromschlaggefahr!**  
Beauftragen Sie mit der Installation eine Elektrofachkraft. Für Strahler, die nicht gemäß den europäischen Sicherheitsrichtlinien installiert wurden, entfällt jeder Haftungsanspruch.
-  **Brandgefahr!**  
Strahler nicht mit wärmedämmenden Stoffen abdecken.
-  **Achtung!**  
Für alle Anschlüsse sekundärseitig des Konverters ist ausschließlich die mitgelieferte Niedervoltleitung zu verwenden.  
Der Strahler ist zur Montage in normal entflammaren Oberflächen geeignet, z.B. auf Holz und Werkstoffen auf Holzbasis mit mehr als 2 mm Stärke. Strahler nur nach unten strahlend montieren.

## HINWEIS:

Dieses Produkt enthält eine Lichtquelle der Energieeffizienzklasse E.

## SYMBOLLE ALLGEMEIN:

 CE-konform mit den zutreffenden europäischen Richtlinien.

 RoHS-Prüfzeichen für Produkte, die keine Schwermetalle beinhalten (2011/65/EU).

 REACH-Prüfzeichen für Produkte, deren chemische Bestandteile bekannt, registriert und zugelassen sind. (1907/2006/EG).

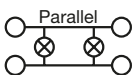
 Parallelanschluss:  
Für die Durchgangsverdrahtung geeignet.

 Nur für den Innenbereich geeignet.

## SYMBOLLE KONVERTER:

 Schutzklasse II

 Kurzschlussfest

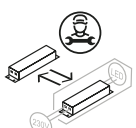
 Betriebsgerät austauschbar durch Elektrofachkraft.

## SYMBOLLE STRAHLER:

 LED-Leuchte oder Betriebsgerät nicht mit Wärmedämmenden Stoffen abdecken.



 LED-Lichtquelle austauschbar durch Elektrofachkraft.

## EINBAU MIT HALTEFEDERN:

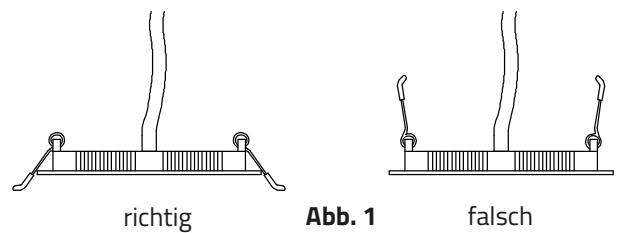
Die Haltefedern müssen nach der Installation in horizontaler Position liegen, nicht vertikal (Abb. 1).



## DREI WEGESCHALTER EINSTELLUNG:

| LEISTUNG   |        |        | LICHTFARBE  |       |       |
|--|--------|--------|---|-------|-------|
|  |        |        |  |       |       |
| 400 mA   | 500 mA | 600 mA | UWW   | WW    | NW    |
| 16 W   | 20 W   | 24 W   | 2700K   | 3000K | 4000K |

## NETZGERÄTE PRO LEITUNGSSCHUTZSCHALTER:

| LS   | B10 | B16 | B25 | C10 | C16 | C25 |
|------|-----|-----|-----|-----|-----|-----|
| Stk. | 30  | 47  | 74  | 42  | 67  | 105 |

## TECHNISCHE DATEN:

**Eingang:**  
220 - 240 V AC, 50/60 Hz

**Ausgang:**  
16/20/24 W max.

**Umgebungstemperatur:**  
-10 bis +40° C

## TECHNISCHE PRODUKTABMESSUNGEN:

### Einbaustrahler:

Außendurchmesser:  $\varnothing$  300 mm  
 Einbaudurchmesser:  $\varnothing$  285 mm  
 Höhe: 22,5 mm  
 Einbautiefe: 30 mm

### Konverter (L x B x H):

113,5 x 35,5 x 23,5 mm

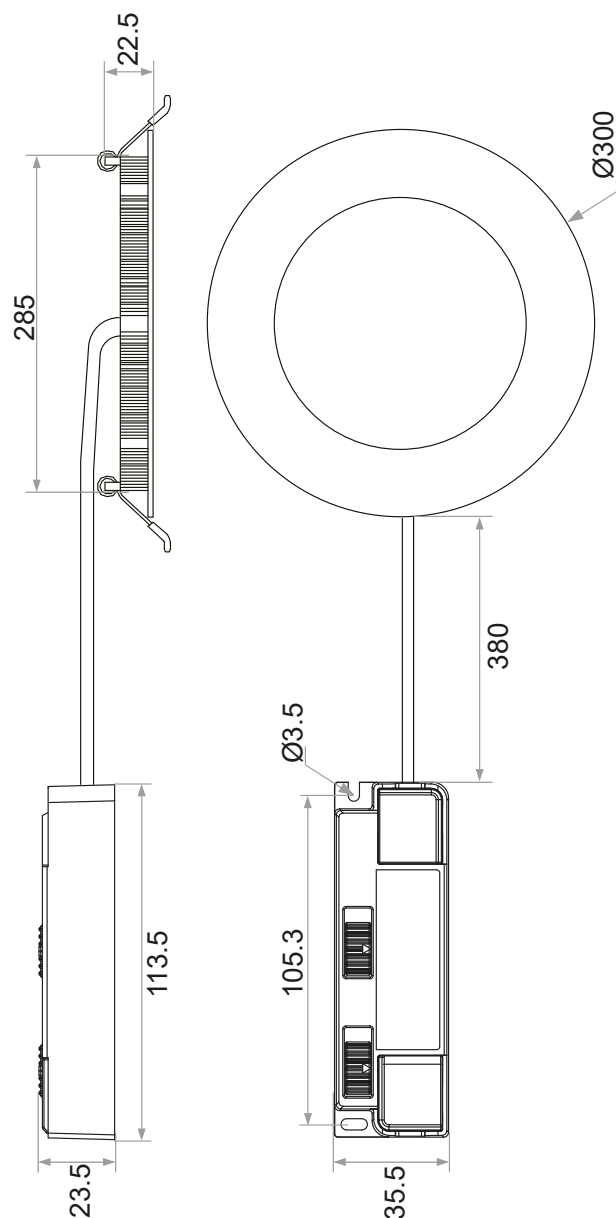

## ENTSORGUNG:



Entsorgen Sie elektrische und elektronische Geräte umweltgerecht. Nähere Informationen erhalten Sie bei Ihrer zuständigen Behörde.

Der TALAN Konverter des Artikels 48503 ist ein primärseitig nicht dimmbarer Konverter, welcher auf der Sekundärseite einen gleichgerichteten konstant Strom von 400/500/600 mA und eine Leistung von 16/20/24 W ausgibt.

## MONTAGE:



### Stromschlaggefahr!

Vor der Installation Spannung abschalten. Sicherstellen, dass die Spannung nicht versehentlich wieder eingeschaltet werden kann.

1. Loch am Montageort sägen. Der Einbaudurchmesser beträgt 285 mm.



2. An die Primärseite des Konverters die vorhandene 230 V AC Netzspannung anschließen (Abb. 2).



Abb. 2

3. Spannen Sie die Federn des Einbaustrahlers ① und setzen ihn den vorbereiteten Deckenausschnitt ein. ② (Abb.3).





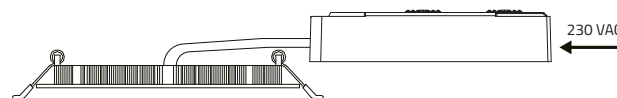

Abb. 3

## INBETRIEBNAHME:

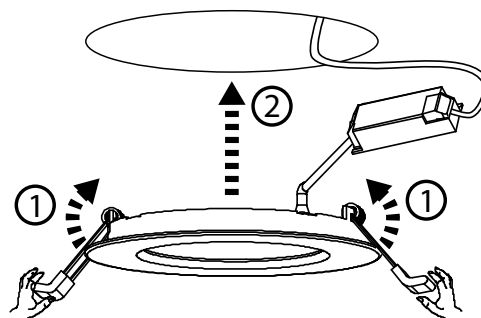
- Betreiben Sie den Schutzklasse II Einbaustrahler TALAN ausschließlich an dem dafür vorgesehenen Konstantstrom-Konverter (im Lieferumfang enthalten).
- Überprüfen Sie ob die Eingangs- und Ausgangsleitungen korrekt angeschlossen worden sind, bevor Sie die Spannung zuschalten um das Produkt in Betrieb zu nehmen.

## SAFETY INSTRUCTIONS:

-  **Risk of electric shock!**  
Be sure to have a professional electrician complete installation. There is no warranty coverage for any lamps installed without observing European safety directives.
-  **Fire hazard!**  
Do not cover lamps with heat insulating materials.
-  **Caution!**  
Only the supplied low voltage cable must be used for all connections on the secondary side of the converter.  
The Downlight is suitable for mounting on normally flammable surfaces such as wood and particle board materials which are more than 2 mm thick. Only install downlights so that they shine downwards.

## NOTICE:

This product contains a light source of energy efficiency class E.

## SYMBOLS IN GENERAL:

 Compliant with the applicable European CE directives.

 RoHS mark for products that do not contain heavy metals (EC Directive 2002/95/EC).

 REACH test mark for products whose chemical components are known, registered and authorised.

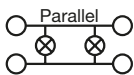
 Parallel circuit:  
Suitable for through-wiring.

 Suitable for indoor use only.

## SYMBOLS LED KONVERTER:

 Protection class II

 Short-circuit proof

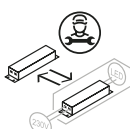
 LED control gear can be replaced by a qualified electrician.

## SYMBOLS LED DOWNLIGHT:

 Do not cover the LED luminaire or control gear with heat-insulating materials.

 LED light source can be replaced by a qualified electrician

## INSTALLATION OF MOUNTING SPRINGS:

Make sure that the springs are in the right position (fig. 1).

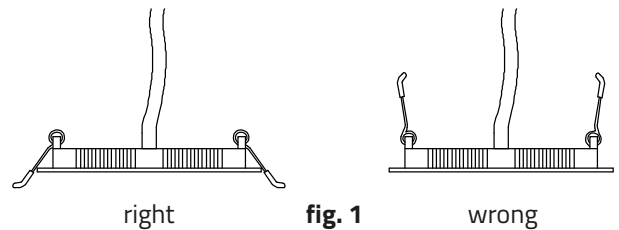

## SLIDE SWITCH ADJUSTMENTS:

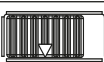
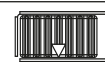
| LOAD   |        |        | LIGHT COLOUR  |       |       |
|--|--------|--------|---|-------|-------|
|  |        |        |  |       |       |
| 400 mA   | 500 mA | 600 mA | UWW   | WW    | NW    |
| 16 W   | 20 W   | 24 W   | 2700K   | 3000K | 4000K |

## POWER SUPPLY UNITS PER CIRCUIT BREAKER:

| CBR  | B10 | B16 | B25 | C10 | C16 | C25 |
|------|-----|-----|-----|-----|-----|-----|
| Pcs. | 30  | 47  | 74  | 42  | 67  | 105 |

## TECHNICAL DATA:

**Input:**  
220 - 240 V AC, 50/60 Hz

**Output:**  
16/20/24 W max.

**Ambient temperature:**  
-10 bis +40° C

## TECHNICAL PRODUCT DIMENSIONS:

### LED Downlight:

outer diameter:  $\varnothing$  300 mm  
 inner diameter:  $\varnothing$  285 mm  
 height: 22.5 mm  
 installation depth: 30 mm

### Converter (L x W x H):

113.5 x 35.5 x 23.5 mm

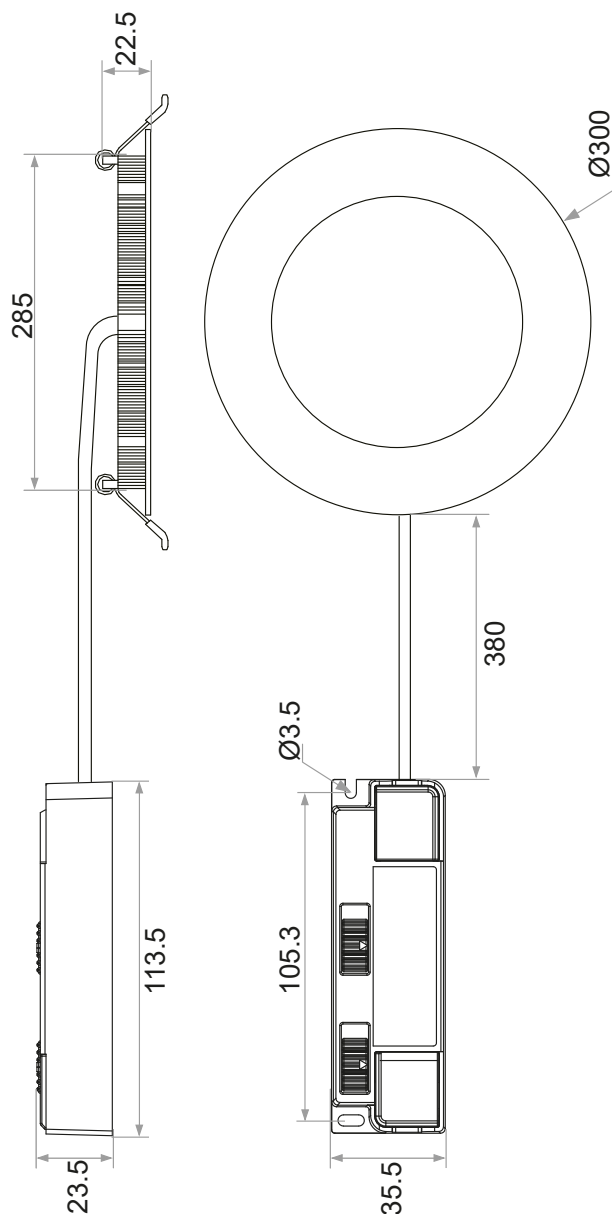

### DISPOSAL:



Dispose of electrical and electronic equipment in an environmentally sound manner. For more information, contact your local authority.

The LED converter of the TALAN 48503 is a non-dimmable converter on the primary side, which provides a rectified constant current of 400/500/600 mA and a maximum power of 16/20/24 W on the secondary side.

## MOUNTING:



### Risk of electric shock!

Switch off voltage prior to installation. Ensure that voltage cannot be accidentally switched on again.

1. Saw a hole at the installation location. The diameter is 285 mm. 
2. Connect the TALAN recessed downlight to the secondary side line of the converter using the connector supplied with the matching counterpart of the connector. Connect the existing 230 V AC mains voltage to the primary side of the converter (fig. 2).

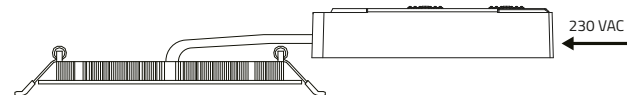

fig. 2

3. Tension the springs of the recessed downlight ① and insert it into the prepared ceiling cut-out ② (fig. 3).

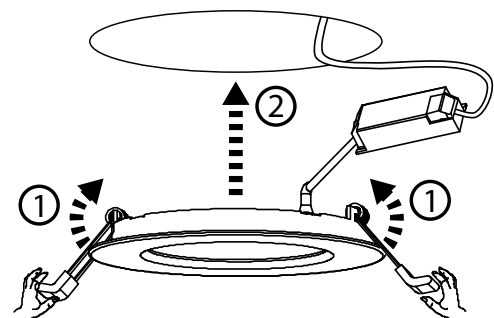

fig. 3

## INSTALLATION:

- Only operate the protection class II recessed downlight TALAN with the constant Current converter provided for it (including in delivery).
- Check that the input and output cables have been connected correctly before switching on the power to operate the product.





