

INSTRUCTION

REGIOLUX

Regiolux GmbH
 Hellingner Str. 3
 D-97486 Königsberg/Bay.
 T 09525 89-0
<http://www.regiolux.de>
 info@regiolux.de

Diese Leuchte enthält ein
 Leuchtmittel der
 Energieeffizienzklasse **B**

This luminaire contains
 a light source of energy
 efficiency class **B**

Achtung:
 Leuchte nicht öffnen!
 Garantieverlust!

Attention:
 Don't open the luminaire!
 Loss of Guarantee!

Attention:
 N'est pas ouvrir le luminaire,
 Perte de garantie!

Atención:
 Non abrir la luminaria!
 Pérdida de garantía!

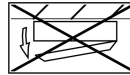

SDGC-LED



SDGSC-LED



SDGVC-LED

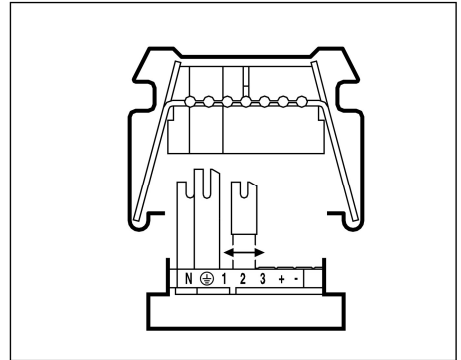
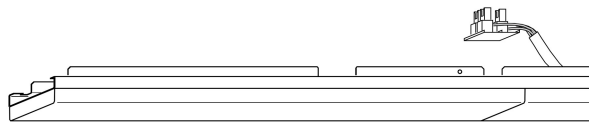

MONTAGE

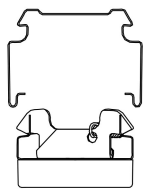

SDGC/SDGVC = "click!" ↑

SDGSC = "power push + click!" ↑↑

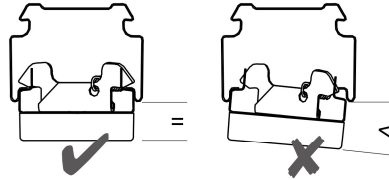

SDGC
 SDGVC

IP20

SDTE

SDGSC

IP64

SDTES

DEMONTAGE

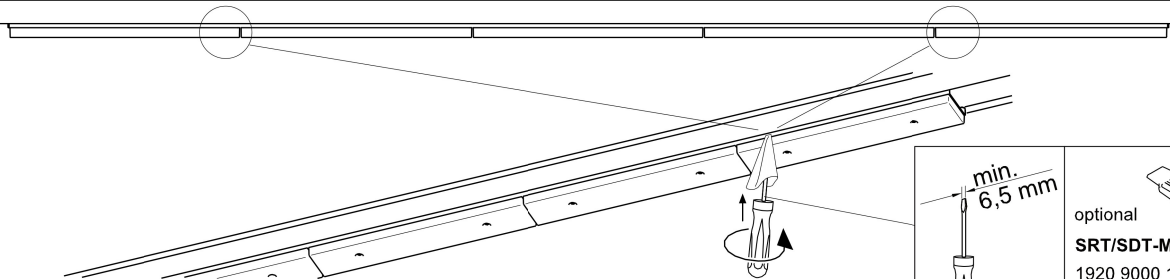

optional
SRT/SDT-MT
 1920 9000 100

SDGVO-LED

SDT

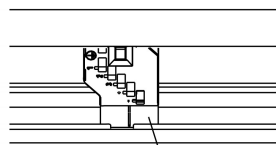

SDGVC



1500

1500

